

SUBCHAPTER D—WATER PROGRAMS (CONTINUED)

PART 136—GUIDELINES ESTABLISHING TEST PROCEDURES FOR THE ANALYSIS OF POLLUTANTS

Sec.

136.1 Applicability.

136.2 Definitions.

136.3 Identification of test procedures.

136.4 Application for alternate test procedures.

136.5 Approval of alternate test procedures.

136.6 Method modifications and analytical requirements.

APPENDIX A TO PART 136—METHODS FOR ORGANIC CHEMICAL ANALYSIS OF MUNICIPAL AND INDUSTRIAL WASTEWATER

APPENDIX B TO PART 136—DEFINITION AND PROCEDURE FOR THE DETERMINATION OF THE METHOD DETECTION LIMIT—REVISION 1.11

APPENDIX C TO PART 136—INDUCTIVELY COUPLED PLASMA—ATOMIC EMISSION SPECTROMETRIC METHOD FOR TRACE ELEMENT ANALYSIS OF WATER AND WASTES METHOD 200.7

APPENDIX D TO PART 136—PRECISION AND RECOVERY STATEMENTS FOR METHODS FOR MEASURING METALS

AUTHORITY: Secs. 301, 304(h), 307 and 501(a), Pub. L. 95-217, 91 Stat. 1566, *et seq.* (33 U.S.C. 1251, *et seq.*) (the Federal Water Pollution Control Act Amendments of 1972 as amended by the Clean Water Act of 1977).

§ 136.1 Applicability.

(a) The procedures prescribed herein shall, except as noted in § 136.5, be used to perform the measurements indicated whenever the waste constituent specified is required to be measured for:

(1) An application submitted to the Administrator, or to a State having an approved NPDES program for a permit under section 402 of the Clean Water Act of 1977, as amended (CWA), and/or to reports required to be submitted under NPDES permits or other requests for quantitative or qualitative effluent data under parts 122 to 125 of title 40, and,

(2) Reports required to be submitted by dischargers under the NPDES established by parts 124 and 125 of this chapter, and,

(3) Certifications issued by States pursuant to section 401 of the CWA, as amended.

(b) The procedure prescribed herein and in part 503 of title 40 shall be used to perform the measurements required for an application submitted to the Administrator or to a State for a sewage sludge permit under section 405(f) of the Clean Water Act and for record-keeping and reporting requirements under part 503 of title 40.

[72 FR 14224, Mar. 26, 2007]

§ 136.2 Definitions.

As used in this part, the term:

(a) *Act* means the Clean Water Act of 1977, Pub. L. 95-217, 91 Stat. 1566, *et seq.* (33 U.S.C. 1251 *et seq.*) (The Federal Water Pollution Control Act Amendments of 1972 as amended by the Clean Water Act of 1977).

(b) *Administrator* means the Administrator of the U.S. Environmental Protection Agency.

(c) *Regional Administrator* means one of the EPA Regional Administrators.

(d) *Director* means the Director of the State Agency authorized to carry out an approved National Pollutant Discharge Elimination System Program under section 402 of the Act.

(e) *National Pollutant Discharge Elimination System (NPDES)* means the national system for the issuance of permits under section 402 of the Act and includes any State or interstate program which has been approved by the Administrator, in whole or in part, pursuant to section 402 of the Act.

(f) *Detection limit* means the minimum concentration of an analyte (substance) that can be measured and reported with a 99% confidence that the analyte concentration is greater than zero as determined by the procedure set forth at appendix B of this part.

[38 FR 28758, Oct. 16, 1973, as amended at 49 FR 43250, Oct. 26, 1984]

§ 136.3 Identification of test procedures.

(a) Parameters or pollutants, for which methods are approved, are listed together with test procedure descriptions and references in Tables IA, IB, IC, ID, IE, IF, IG, and IH. In the event

§ 136.3

40 CFR Ch. I (7–1–08 Edition)

of a conflict between the reporting requirements of 40 CFR Parts 122 and 125 and any reporting requirements associated with the methods listed in these tables, the provisions of 40 CFR Parts 122 and 125 are controlling and will determine a permittee's reporting requirements. The full text of the referenced test procedures are incorporated by reference into Tables IA, IB, IC, ID, IE, IF, IG, and IH. The incorporation by reference of these documents, as specified in paragraph (b) of this section, was approved by the Director of the Federal Register in accordance with 5 U.S.C. 552(a) and 1 CFR Part 51. Copies of the documents may be obtained from the sources listed in paragraph (b) of this section. Documents may be inspected at EPA's Water Docket, EPA West, 1301 Constitution Avenue, NW., Room B102, Washington, DC (Telephone: 202-566-2426); or at the National Archives and Records Admin-

istration (NARA). For information on the availability of this material at NARA, call 202-741-6030, or go to: http://www.archives.gov/federal_register/code_of_federal_regulations/ibr_locations.html. These test procedures are incorporated as they exist on the day of approval and a notice of any change in these test procedures will be published in the FEDERAL REGISTER. The discharge parameter values for which reports are required must be determined by one of the standard analytical test procedures incorporated by reference and described in Tables IA, IB, IC, ID, IE, IF, IG, and IH or by any alternate test procedure which has been approved by the Administrator under the provisions of paragraph (d) of this section and §§ 136.4 and 136.5. Under certain circumstances paragraph (c) of this section, § 136.5(a) through (d) or 40 CFR 401.13, other additional or alternate test procedures may be used.

TABLE IA—LIST OF APPROVED BIOLOGICAL METHODS FOR WASTEWATER AND SEWAGE SLUDGE

| Parameter and units | Method ¹ | EPA | Standard methods 18th, 19th, 20th ed. | Standard methods on-line | AOAC, ASTM, USGS | Other | |
|---------------------|--|---|---------------------------------------|--|--------------------------|--|-------------------------------|
| Bacteria: | 1. Coliform (fecal), number per 100 mL or number per gram dry weight. | p. 132 ³ 1680 ^{12,14} 1681 ^{12,19} | 9221 C E | 9221 C E-99. | | | |
| | 2. Coliform (fecal) in presence of chlorine, number per 100 mL. | p. 124 ³ | 9222 D | 9222 D-97 | B-0050-85 ⁵ . | | |
| | 3. Coliform (total), number per 100 mL. | p. 132 ³ | 9221 C E | 9221 C E-99. | | | |
| | 4. Coliform (total), in presence of chlorine, number per 100 mL. | p. 124 ³ p. 114 ³ | 9222 D 9221 B | 9222 D-97 9221 B-99. | | | |
| | 5. <i>E. coli</i> , number per 100 mL ²⁰ . | p. 108 ³ p. 114 ³ | 9222 B 9221 B | 9222 B-97 9221 B-99. | B-0025-8 ⁵ . | | |
| | 6. Fecal streptococci, number per 100 mL. | p. 111 ³ | 9222 (B+B.5c) 9223 B ¹³ | 9222 (B+B.5c) - 97. 9223 B-97 ¹³ | 991.15 ¹¹ | Colilert [®] 13,17 Colilert-18 [®] 13,16,17 mColiBlue-24 [®] 18 | |
| | 7. Enterococci, number per 100 mL ²⁰ . | 1603 ²¹ p. 139 ³ | 9230 B | 9230 B-93. | | | |
| | 8. <i>Salmonella</i> , number per gram dry weight ¹² . | p. 136 ³ p. 143 ³ | 9230 C | 9230 C-93 | B-0055-85 ⁵ . | | |
| | 9. Aquatic Toxicity: water organisms, LC ₅₀ , percent effluent. | 1600 ²⁴ , 1682 ²² . | | | | D6503-99 ¹⁰ | Enterolert [®] 13,23 |
| | | 2002.0 ²⁵ . | | | | | |
| | 2021.0 ²⁵ . | | | | | | |
| | 2000.0 ²⁵ . | | | | | | |
| | 2019.0 ²⁵ . | | | | | | |

TABLE IA—LIST OF APPROVED BIOLOGICAL METHODS FOR WASTEWATER AND SEWAGE SLUDGE—Continued

| Parameter and units | Method ¹ | EPA | Standard methods 18th, 19th, 20th ed. | Standard methods on-line | AOAC, ASTM, USGS | Other |
|--|--|------------------------|---------------------------------------|--------------------------|------------------|-------|
| 10. Toxicity, acute, estuarine and marine organisms of the Atlantic Ocean and Gulf of Mexico, LC ₅₀ , percent effluent. | Mysid, <i>Mysidopsis bahia</i> , acute | 2007.0 ²⁵ . | | | | |
| | Sheepshead <i>Cyprinodon variegatus</i> , acute. | 2004.0 ²⁵ . | | | | |
| | Silverside, <i>Menidia beryllina</i> , <i>Menidia menidia</i> , and <i>Menidia peninsulae</i> , acute. | 2006.0 ²⁵ . | | | | |
| 11. Toxicity, chronic, fresh water organisms, NOEC or IC ₂₅ , percent effluent. | Fathead minnow, <i>Pimephales promelas</i> , larval survival and growth. | 1000.0 ²⁶ . | | | | |
| | Fathead minnow, <i>Pimephales promelas</i> , embryo-larval survival and teratogenicity. | 1001.0 ²⁶ . | | | | |
| | Daphnia, <i>Ceriodaphnia dubia</i> , survival and reproduction. | 1002.0 ²⁶ . | | | | |
| | Green alga, <i>Selenastrum capricornutum</i> , growth. | 1003.0 ²⁶ . | | | | |
| 12. Toxicity, chronic, estuarine and marine organisms of the Atlantic Ocean and Gulf of Mexico, NOEC or IC ₂₅ , percent effluent. | Sheepshead minnow, <i>Cyprinodon variegatus</i> , larval survival and growth. | 1004.0 ²⁷ . | | | | |
| | Sheepshead minnow, <i>Cyprinodon variegatus</i> , embryo-larval survival and teratogenicity. | 1005.0 ²⁷ . | | | | |
| | Inland silverside, <i>Menidia beryllina</i> , larval survival and growth. | 1006.0 ²⁷ . | | | | |
| | Mysid, <i>Mysidopsis bahia</i> , survival, growth, and fecundity. | 1007.0 ²⁷ . | | | | |
| | Sea urchin, <i>Arbacia punctulata</i> , fertilization. | 1008.0 ²⁷ . | | | | |

¹ The method must be specified when results are reported.
² A 0.45 µm membrane filter (MF) or other pore size certified by the manufacturer to fully retain organisms to be cultivated and to be free of extractables which could interfere with their growth.
³ USEPA, 1978. Microbiological Methods for Monitoring the Environment, Water, and Wastes. Environmental Monitoring and Support Laboratory, U.S. Environmental Protection Agency, Cincinnati, OH. EPA/600/8-78/017.
⁴ [Reserved]

⁵ USGS, 1989. U.S. Geological Survey Techniques of Water-Resource Investigations, Book 5, Laboratory Analysis, Chapter A4, Methods for Collection and Analysis of Aquatic Biological and Microbiological Samples, U.S. Geological Survey, U.S. Department of the Interior, Reston, VA.

⁶ Because the MF technique usually yields low and variable recovery from chlorinated wastewaters, the Most Probable Number method will be required to resolve any controversies.

⁷ Tests must be conducted to provide organism enumeration (density). Select the appropriate configuration of tubefiltrations and dilutions/volumes to account for the quality, character, consistency, and anticipated organism density of the water sample.

⁸ When the MF method has been used previously to test waters with high turbidity, large numbers of noncoliform bacteria, or samples that may contain organisms stressed by chlorine, a parallel test should be conducted with a multiple-tube technique to demonstrate applicability and comparability of results.

⁹ To assess the comparability of results obtained with individual methods, it is suggested that side-by-side tests be conducted across seasons of the year with the water samples routinely tested in accordance with the most current Standard Methods for the Examination of Water and Wastewater or EPA alternate test procedure (ATP) guidelines.

¹⁰ ASTM, 2000, 1999, 1996. Annual Book of ASTM Standards—Water and Environmental Technology, Section 11.02. ASTM International, 100 Barr Harbor Drive, West Conshohocken, PA 19428.

¹¹ AOAC, 1995. Official Methods of Analysis of AOAC International, 16th Edition, Volume 1, Chapter 17. Association of Official Analytical Chemists International, 481 North Frederick Avenue, Suite 500, Gaithersburg, MD 20877-2417.

¹² Recommended for enumeration of target organism in sewage sludge.

¹³ These tests are collectively known as defined enzyme substrate tests, where, for example, a substrate is used to detect the enzyme β-glucuronidase produced by *E. coli*.

¹⁴ USEPA, July 2006. Method 1680: Fecal Coliforms in Sewage Sludge (Biosolids) by Multiple-Tube Fermentation Using Lauryl-Tryptose Broth (LTB) and EC Medium. US Environmental Protection Agency, Office of Water, Washington, DC EPA-821-R-06-012.

¹⁵ Samples shall be enumerated by the multiple-tube or multiple-well procedure. Using multiple-tube procedures, employ an appropriate tube and dilution configuration of the sample as needed and report the Most Probable Number (MPN). Samples tested with Coli-Test[®] may be enumerated with the multiple-well procedures, Quanti-Tray[®] 2000, and the MPN calculated from the table provided by the manufacturer.

¹⁶ Coli-Test[®] is an optimized formulation of the Coli-Test[®] for the determination of total coliforms and *E. coli* that provides results within 18 h of incubation at 35 °C rather than the 24 h required for the Coli-Test[®] test and is recommended for marine water samples.

¹⁷ Descriptions of the mColiBlueZ[®] test, Total Coliforms and *E. coli*, and Quanti-Tray[®] 2000 may be obtained from IDEXX Laboratories, Inc., 1 IDEXX Drive, Westbrook, ME 04092.

¹⁸ A description of the mColiBlueZ[®] test, Total Coliforms and *E. coli*, is available from Hach Company, 100 Dayton Ave., Ames, IA 50010.

¹⁹ USEPA, July 2006. Method 1681: Fecal Coliforms in Sewage Sludge (Biosolids) by Multiple-Tube Fermentation using A-1 Medium. U.S. Environmental Protection Agency, Office of Water, Washington, DC EPA-821-R-06-013.

²⁰ Recommended for enumeration of target organism in wastewater effluent.

²¹ USEPA, July 2006. Method 1603: *Escherichia coli* (*E. coli*) in Water by Membrane Filtration Using Modified membrane-Thermotolerant *Escherichia coli* Agar (modified mTEC), U.S. Environmental Protection Agency, Office of Water, Washington, DC EPA-821-R-06-011.

²² USEPA, July 2006. Method 1682: *Salmonella* in Sewage Sludge (Biosolids) by Modified Semisolid Rappaport-Vassiliadis (MSRV) Medium. U.S. Environmental Protection Agency, Office of Water, Washington, DC EPA-821-R-06-014.

²³ A description of the Enterolert[®] test may be obtained from IDEXX Laboratories, Inc., 1 IDEXX Drive, Westbrook, ME 04092.

²⁴ USEPA, July 2006. Method 1600: Enterococci in Water by Membrane Filtration Using membrane-Enterococcus Indoxyl-β-D-Glucoside Agar (mEI), U.S. Environmental Protection Agency, Office of Water, Washington, DC EPA-821-R-06-009.

²⁵ USEPA, October 2002. Methods for Measuring the Acute Toxicity of Effluents and Receiving Waters to Freshwater and Marine Organisms. Fifth Edition. U.S. Environmental Protection Agency, Office of Water, Washington, DC EPA/621/R-02/012.

²⁶ USEPA, October 2002. Short-term Methods for Estimating the Chronic Toxicity of Effluents and Receiving Waters to Freshwater Organisms. Fourth Edition. U.S. Environmental Protection Agency, Office of Water, Washington, DC EPA/621/R-02/013.

²⁷ USEPA, October 2002. Short-term Methods for Estimating the Chronic Toxicity of Effluents and Receiving Waters to Marine and Estuarine Organisms. Third Edition. U.S. Environmental Protection Agency, Office of Water, Washington, DC EPA/621/R-02/014.

TABLE IB—LIST OF APPROVED INORGANIC TEST PROCEDURES

| Parameter | Methodology ³⁸ | Reference (method number or page) | | | | USGS/AOAC/ other |
|--|---|-----------------------------------|---------------------------------------|---------------------------------|---------------------------------|--|
| | | EPA ^{35,52} | Standard meth- ods (18th, 19th) | Standard meth- ods (20th) | Standard meth- ods online | |
| 1. Acidity, as CaCO ₃ , mg/L. | Electrometric endpoint or phenolphthalein endpoint. | | 2310 B(4a) | 2310 B(4a) | 2310 B(4a)–97 ... | D1067–92, 02 I-1020–85 ² |

TABLE IB—LIST OF APPROVED INORGANIC TEST PROCEDURES—Continued

| Parameter | Methodology. ³⁸ | Reference (method number or page) | | | | | USGS/AOAC/ other |
|--|---|--|---------------------------------------|---------------------------------|------------------------------------|----------------------|--|
| | | EPA. ^{35, 52} | Standard meth- ods (18th, 19th) | Standard meth- ods (20th) | Standard meth- ods online | ASTM | |
| 2. Alkalinity, as CaCO ₃ , mg/L. | Electrometric or Col- orimetric titration to pH 4.5, manual, or automatic | | 2320 B | 2320 B | 2320 B-97 | D1067-92, 02 | 973.43 ³ , I- 1030-85 ² |
| | Digestion ⁴ followed by: AA direct aspira- tion ³⁶ , AA furnace | 310.2 (Rev. 1974) ¹ , | | | | | I-2030-85 ² |
| 3. Aluminum—Total, ⁴ mg/ L. | AA direct aspira- tion ³⁶ , AA furnace | | 3111 D | | 3111 D-99 | | I-3051-85 ² |
| | STGFAA | 200.9, Rev. 2.2 (1994), | 3113 B | | 3113 B-99. | | |
| | ICP/AES ³⁶ | 200.7, Rev. 4.4 (1994), | 3120 B | 3120 B | 3120 B-99 | | I-4471-9750 |
| | ICP/MS | 200.8, Rev. 5.4 (1994), | | | | D5673-03 | 993.14 ³ |
| | Direct Current Plas- ma (DCP) ³⁶ , Colorimetric (Eriochrome cyanine R). Manual, distillation (at pH 9.5) e fol- lowed by: Nesslerization | | 3500-AI D | 3500-AI B | 3500-AI B | 3500-AI B-01. | D4190-94, 99 |
| 4. Ammonia (as N), mg/L | | | 4500-NH B ₃ | 4500-NH ₃ B | 4500-NH ₃ B-97 | | 973.49 ³ |
| | | 4500-NH ₃ C (18th only), 4500-NH ₃ C (19th) and 4500-NH ₃ E (18th), 4500-NH ₃ D or E (18th) and 4500-NH ₃ F or G (18th). | | 4500-NH ₃ C | 4500-NH ₃ C-97. | | 973.49 ³ , I- 3520-85 ² |
| | | | 4500-NH ₃ D or E. | 4500-NH ₃ D or E. | 4500-NH ₃ D or E-97. | D1426-98, 03 (A). | |
| | | | | | | D1426-98, 03 (B). | |

| | | | | | | |
|--|---|---|----------------------------|---------------------------|----------------------|----------------------------|
| Automated phenate, or. | 350.1 ⁶⁰ , Rev. 2.0 (1993). | 4500-NH ₃ G (19th) and 4500-NH ₃ H (18th). | 4500-NH ₃ G ... | 4500-NH ₃ G-97 | | I-4523-85 ² |
| Automated electrode ion Chromatography Digestion ⁴ followed by: AA direct aspira- tion ³⁶ . | | | | | | See footnote 7 |
| AA furnace STGFAA | 200.9, Rev. 2.2 (1994). | 3111 B 3113 B | | 3111 B-99. 3113 B-99. | D6919-03. | |
| ICP/AES ³⁶ | 200.7, Rev. 4.4 (1994). | 3120 B | 3120 B | 3120 B-99. | | |
| ICP/MS | 200.8, Rev. 5.4 (1994). | | | | D5673-03 | 993.14 ³ |
| Digestion ⁴ followed by: AA gaseous hydride | 206.5 (Issued 1978) ¹ . | 3114 B 4.d | | 3114 B 4.d-97 ... | D2972-97, 03 (B). | I-3062-85 ² |
| AA furnace | | 3113 B | | 3113 B-99 | D2972-97, 03 (C). | I-4063-98 ⁴⁹ |
| STGFAA | 200.9, Rev. 2.2 (1994). | 3120 B | 3120 B | 3120 B-99. | | |
| ICP/AES ³⁶ | 200.7, Rev. 4.4 (1994). | | | | D5673-03 | 993.14 ³ |
| ICP/MS | 200.8, Rev. 5.4 (1994). | 3500-As C | 3500-As B | 3500-As B-97 ... | D2972-97, 03 (A). | I-3060-85 |
| Colorimetric (SDDC) | | | | | | |
| Digestion ⁴ followed by: AA direct aspira- tion ³⁶ | | 3111 D | | 3111 D-99 | | I-3084-85 ² |
| AA furnace ICP/AES ³⁶ | 200.7, Rev. 4.4 (1994). | 3113 B 3120 B | 3120 B | 3113 B-99 3120 B-99. | D4382-95, 02. | |
| ICP/MS | 200.8, Rev. 5.4 (1994). | | | | D5673-03 | 993.14 ³ |
| DCP ³⁶ Digestion ⁴ followed by: | | | | | | See footnote ³⁴ |
| 5. Antimony—Total, ⁴ mg/ L. | | | | | | |
| 6. Arsenic—Total, ⁴ mg/L | | | | | | |
| 7. Barium—Total, ⁴ mg/L .. | | | | | | |
| 8. Beryllium—Total, ⁴ mg/L | | | | | | |

TABLE IB—LIST OF APPROVED INORGANIC TEST PROCEDURES—Continued

| Parameter | Methodology ³⁸ | Reference (method number or page) | | | | | ASTM | USGS/AOAC/ other |
|--|--|---|---------------------------------------|---------------------------------|---------------------------------|--------------------------------------|--|---------------------|
| | | EPA ^{35,52} | Standard meth- ods (18th, 19th) | Standard meth- ods (20th) | Standard meth- ods online | | | |
| 9. Biochemical oxygen de- mand (BOD ₅), mg/L. | AA direct aspiration | | 3111 D | | 3111 D-99 | D3645-93 (88), 03 (A). | I-3095-85 ² | |
| | AA furnace | | 3113 B | | 3113 B-99 | D3645-93 (88), 03 (B). | | |
| | STGFAA | 200.9, Rev. 2.2 (1994). | | | 3120 B-99 | | I-4471-97 ⁵⁰ | |
| | ICP/AES | 200.7, Rev. 4.4 (1994). | 3120 B | 3120 B | | | 993.14 ³ | |
| | ICP/MS | 200.8, Rev. 5.4 (1994). | | | | D5673-03 | See footnote ³⁴ | |
| 10. Boron—Total, ³⁷ mg/L | DCP, or Colorimetric (aluminon). | | 3500-Be D. | | | | 973.44, ³ p. 17. ⁹ I-1578- 78. ⁸ | |
| | Dissolved Oxygen Depletion. | | 5210 B | 5210 B | 5210 B-01 | | I-3112-85 ² | |
| | Colorimetric (cur- cumin). | | 4500-B B | 4500-B B | 4500-B B-00 | | I-4471-97 ⁵⁰ | |
| 11. Bromide, mg/L | ICP/AES, or | 200.7, Rev. 4.4 (1994). | 3120 B | 3120 B | 3120 B99 | D4190-94, 99 D1246-95, 99 (C). | See footnote ³⁴ p. S44. ¹⁰ | |
| | DCP Titrimetric | | | | | D4327-97, 03 | I-1125-85 ² 993.30 ³ | |
| 12. Cadmium—Total, ⁴ mg/ L. | Ion Chromatography | 300.0, Rev 2.1 (1993) and 300.1, Rev 1.0 (1997). | 4110 B | 4110 B | 4110 B-00 | | D6508, Rev. 2. ⁵⁴ | |
| | CIE/UV | | | | | | 974.27, ³ p. 37. ⁹ I-3135- 85 ² or I- 3136-85 ² | |
| | Digestion ⁴ followed by AA direct aspira- tion ³⁶ . | | 3111 B or C | | 3111 B or C-99 | D3557-95, 02 (A or B). | | |

| | | | | |
|--|----------------------------------|-----------|-------------------|---|
| AA furnace | 3113 B | 3113 B-99 | D3557-95, 02 (D). | I-4138-89 ⁵¹ |
| STGFAA | 200.9, Rev. 2.2 (1994). | | | |
| ICP/AES ³⁶ | 200.7, Rev. 4.4 (1994). | 3120 B | | I-1472-85 ² or I-4471-97 ⁵⁰ |
| ICP/MS | 200.8, Rev. 5.4 (1994). | | D5673-03 | 993.14 ³ |
| DCP ³⁶ | | | | See footnote ³⁴ |
| Voltametry ¹¹ , or | | | | |
| Colorimetric (Dithione), | 3500-Cd D. | | | |
| Digestion ⁴ followed by: | | | | |
| AA direct aspiration | 3111 B | 3111 B-99 | D511-93, 03(B) | I-3152-85 ² |
| ICP/AES | 200.7, Rev. 4.4 (1994). | 3120 B | | I-4471-97 ⁵⁰ |
| DCP, or | | | | See footnote ³⁴ |
| Titrimetric (EDTA) | | 3500-Ca B | | |
| Ion Chromatography | | 3500-Ca B | | |
| Dissolved Oxygen | | 5210 B | | |
| Depletion with nitric acid | | | | |
| Titrimetric | | | | |
| Spectrophotometric, manual or automatic. | 410.3 (Rev. 1978) ¹ . | 5220 C | D1252-95, 00 (A). | 973.46 ³ , p. 17 ⁹ |
| Titrimetric: (silver nitrate) or. (Mercuric nitrate) | 410.4, Rev. 2.0 (1993). | 5220 D | D1252-95, 00 (B). | I-3560-85 ² |
| Colorimetric: manual or. Automated (Ferricyanide). | | 4500-Cl-B | D512-89(99) (B). | See footnote ^{13, 14} , I-3561-85 ² |
| Potentiometric Titration. | | 4500-Cl-C | D512-89 (99) (A). | I-1183-85 ² |
| Ion Selective Electrode. | | | | 973.51 ³ , I-1184-85 ² |
| | | 4500-Cl-E | | I-1187-85 ² |
| | | 4500-Cl-D | | I-2187-85 ² |
| | | | D512-89(99)(C). | |

13. Calcium—Total,⁴ mg/L

14. Carbonaceous biochemical oxygen demand (CBOD₅), mg/L¹².

15. Chemical oxygen demand (COD), mg/L.

16. Chloride, mg/L

TABLE IB—LIST OF APPROVED INORGANIC TEST PROCEDURES—Continued

| Parameter | Methodology ³⁸ | Reference (method number or page) | | | | ASTM | USGS/AOAC/ other |
|---|---|--|---------------------------------------|---------------------------------|---------------------------------|--------------------|--|
| | | EPA ^{35,52} | Standard meth- ods (18th, 19th) | Standard meth- ods (20th) | Standard meth- ods online | | |
| 17. Chlorine—Total residual, mg/L; Titrimetric. | Ion Chromatography | 300.0, Rev. 2.1 (1993) and 300.1, Rev. 1.0 (1997). | 4110 B | 4110 B | 4110 B-00 | D4327-97, 03 | 993.30 ³ |
| | CIE/UV | | | | | | D6508, Rev. 2 ⁵⁴ |
| | Amperometric direct, or. | | 4500-CI D | 4500-CI D | 4500-CI D-00 | D1253-86 (96), 03. | |
| | Amperometric direct (low level). | | 4500-CI E | 4500-CI E | 4500-CI E-00. | | |
| | Iodometric direct | | 4500-CI B | 4500-CI B | 4500-CI B-00. | | |
| | Back titration ether end-point ¹⁵ or. | | 4500-CI C | 4500-CI C | 4500-CI C-00. | | |
| | DPD-FAS | | 4500-CI F | 4500-CI F | 4500-CI F-00. | | |
| | Spectrophotometric, DPD or. | | 4500-CI G | 4500-CI G | 4500-CI G-00. | | |
| | Electrode | | | | | | See footnote ¹⁶ |
| | 0.45-micron Filtration followed by: | | | | | | |
| 18. Chromium VI dissolved, mg/L. | AA chelation-extraction or. | | 3111 C | | 3111 C-99 | | I-1232-85 |
| | Ion Chromatography | 218.6, Rev. 3.3 (1994). | 3500-Cr E | 3500-Cr C | 3500-Cr C-01 | D5257-97 | 993.23 |
| | Colorimetric (Di-phenyl-carbazide). Digestion ⁴ followed by: | | 3500-Cr D | 3500-Cr B | 3500-Cr B-01 | D1687-92, 02 (A). | I-1230-85 |
| 19. Chromium—Total, mg/L. | AA direct aspiration ³⁶ . | | 3111 B | | 3111 B-99 | D1687-92, 02 (B). | 974.27 ³ , I-3236-85 ² |
| | AA chelation-extraction. | | 3111 C | | 3111 C-99. | | |
| | AA furnace | | 3113 B | | 3113 B-99 | D1687-92, 02 (C). | I-3233-93 ⁴⁶ |
| | STGFAA | 200.9, Rev. 2.2 (1994). | | | | | |

| | | | | | | |
|---|--|-------------------------|-----------------|----------------------|------------------------|---|
| 20. Cobalt—Total, ⁴ mg/L | ICP/AES ³⁶ | 3120 B | 3120 B | 3120 B-99 | D5673-03 | 993.14 ³ |
| | ICP/MS | | | | D4190-94, 99 | See footnote ³⁴ |
| | DCP, ³⁶ or | 3500-Cr D | 3500-Cr B | 3500-Cr B-01 | | |
| | Colorimetric (Di-phenyl-carbazide) Digestion ⁴ followed by: | | | | | |
| | AA direct aspiration | 3111 B or C | | 3111 B or C-99 | D3558-94, 03 (A or B), | p. 37 ⁹ , I-3239-85 ² |
| | AA furnace | 3113 B | | 3113 B-99 | D3558-94, 03 (C). | I-4243-89 ⁵¹ |
| | STGFAA | 200.9, Rev. 2.2 (1994). | | 3120 B-99 | | I-4471-97 ⁵⁰ |
| | ICP/AES | 200.7, Rev. 4.4 (1994). | 3120 B | | D5673-03 | 993.14 ³ |
| | ICP/MS | 200.8, Rev. 5.4 (1994). | | | D4190-94, 99 | See footnote ³⁴ |
| | DCP | | 2120 E | | | See footnote ¹⁸ |
| 21. Color, platinum cobalt units or dominant wavelength, hue, luminance purity. | Colorimetric (ADMI), or | 2120 E | 2120 E | | | |
| | (Platinum cobalt), or Spectrophotometric Digestion ⁴ followed by: | 2120 B | 2120 B | 2120 B-01 | | I-1250-85 ² |
| | AA direct aspiration ³⁶ | 2120 C | 2120 C | | | |
| 22. Copper—Total, ⁴ mg/L | AA furnace | 3111 B or C | | 3111 B or C-99 | D1688-95, 02 (A or B), | 974.27 ³ p. 37 ⁹ , I-3270-85 ² or I-3271-85 ² |
| | STGFAA | 3113 B | | 3113 B-99 | D1688-95, 02 (C). | I-4274-89 ⁵¹ |
| | ICP/AES ³⁶ | 200.9, Rev. 2.2 (1994). | 3120 B | 3120 B-99 | | I-4471-97 ⁵⁰ |
| | ICP/MS | 200.7, Rev. 4.4 (1994). | | | D5673-03 | 993.14 ³ |
| | DCP ³⁶ or | 200.8, Rev. 5.4 (1994). | 3500-Cu D | 3500-Cu B-99 | D4190-94, 99 | See footnote ³⁴ |
| | Colorimetric (Neocuproine) or. (Bicinchoninate) | 3500-Cu E | 3500-Cu C | 3500-Cu C-99 | | See footnote ¹⁹ |

TABLE IB—LIST OF APPROVED INORGANIC TEST PROCEDURES—Continued

| Parameter | Methodology ⁵⁸ | Reference (method number or page) | | | | | ASTM | USGS/AOAC/ other |
|------------------------------|--|--|---------------------------------------|----------------------------------|--|--|--|---------------------|
| | | EPA ^{35,52} | Standard meth- ods (18th, 19th) | Standard meth- ods (20th) | Standard meth- ods online | | | |
| 23. Cyanide—Total, mg/L | Automated Distillation and Colorimetry, or: | | | | | | Kelada-01 ⁵⁵ | |
| | Manual distillation with MgCl ₂ followed by: Titrimetric or Spectrophotometric, manual or. Automated ²⁰ or | 335.4, Rev. 1.0 (1993) ⁵⁷ . | 4500-CN-C | 4500-CN-C | | D2036-98(A) | 10-204-00-1-X ⁵⁶ | |
| 24. Available Cyanide, mg/L. | Ion Selective Electrode. | | | | | | p. 22 ⁹ I-3300-85 | |
| | Cyanide Amenable to Chlorination (CATC); Manual distillation with MgCl ₂ followed by Titrimetric or Spectrophotometric. | 335.4, Rev. 1.0 (1993) ⁵⁷ . | 4500-CN-D 4500-CN-E | 4500-CN-D 4500-CN-E | 4500-CN-D-99 4500-CN-E-99 | D2036-98(A) | 10-204-00-1-X ⁵⁶ , I-4302-85 ² | |
| 25. Fluoride—Total, mg/L | Flow injection and ligand exchange, followed by amperometry ⁶¹ . | | | | | | OIA-1677 ⁴⁴ | |
| | Automated Distillation and Colorimetry. Manual distillation ⁶ followed by: Electrode, manual or Automated Colorimetric, (SPADNS) or. | | 4500-F-B 4500-F-B 4500-F-D | 4500-F-B 4500-F-B 4500-F-D | 4500-F-B-97. 4500-F-C-97 4500-F-D-97 | D6888-04 D1179-93, 99 (B). D1179-93, 99 (A). | Kelada-01 ⁵⁵ I-4327-85 ² | |

| | | | | | | |
|--|---|---|---|--|--|---|
| Automated complexone. Ion Chromatography | 300.0, Rev 2.1 (1993) and 300.1, Rev 1.0 (1997). | 4500-F-E 4110 B | 4500-F-E 4110 B | 4500-F-E-97. 4110 B-00 | D4327-97.03 | 993.30 ³ D6508, Rev. 2 ⁵⁴ |
| 26. Gold—Total, ⁴ mg/L | CIE/UV | 3111 B | 3111 B | 3111 B-99. | | |
| 27. Hardness—Total, as CaCO ₃ , mg/L. | Digestion ⁴ followed by: AA direct aspiration, or AA furnace, or | 3111 B | 3111 B | 3111 B-99. | | |
| 28. Hydrogen ion (pH), pH units. | DCP | 2340 B or C | 2340 B or C | 2340 B or C-97 | D1126-86(92), 02. | 973.5 2B ³ , I-1338-85 ² |
| 29. Iridium—Total, ⁴ mg/L | Automated colorimetric. Titrimetric (EDTA) or Ca plus Mg as their carbonates, by inductively coupled plasma or AA direct aspiration. (See Parameters 13 and 33). Electrometric measurement or. Automated electrode | 130.1 (Issued 1971) ¹ . | 2340 B or C | 4500-H ⁺ B-00 .. | D1293-84 (90), 99 (A or B). | 973.41. ³ , I-1586-85 ² See footnote ²¹ , I-2587-85 ² |
| 30. Iron—Total, ⁴ mg/L | Digestion ⁴ followed by: AA direct aspiration or. AA furnace | 150.2 (Dec. 1982) ¹ . | 4500-H ⁺ B | 4500-H ⁺ B | | |
| | Digestion ⁴ followed by: AA direct aspiration ³⁶ . AA furnace | 235.2 (Issued 1978) ¹ . | 3111 B | 3111 B-99. | | |
| | STGFAA | 200.9, Rev. 2.2 (1994). | 3111 B or C 3113 B | 3111 B or C-99 3113 B-99 | D1068-96, 03 (A or B). D1068-96, 03 (C). | 974.27 ³ , I-3381-85 ² |

TABLE IB—LIST OF APPROVED INORGANIC TEST PROCEDURES—Continued

| Parameter | Methodology ³⁸ | Reference (method number or page) | | | | | ASTM | USGS/AOAC/ other |
|--|--|---|---|---|---|--|----------------------------|--|
| | | EPA ^{35,52} | Standard meth- ods (18th, 19th) | Standard meth- ods (20th) | Standard meth- ods or line | Standard meth- ods or line | | |
| 31. Kjeldahl Nitrogen ⁵ — Total, (as N), mg/L. | ICP/AES ³⁶ | 200.7, Rev. 4.4 (1994). | 3120 B | 3120 B | 3120 B-99 | | I-4471-97 ⁵⁰ | |
| | DCP ³⁶ or | | | | | | See footnote ³⁴ | |
| | Colorimetric (Phenanthroline). Digestion and distillation followed by; ⁴⁰ | | 3500-Fe D | 3500-Fe B | 3500-Fe B-97 | D4190-94, 99 D1068-96, 03 (D). D3590-89, 02 (A). | See footnote ²² | |
| | Titration or | | 4500-N _{org} B or C and 4500- NH ₃ B. 4500-NH ₃ C (19th) and 4500-NH ₃ E (18th). 4500-NH ₃ C (18th Only). 4500-NH ₃ F or G (18th) and 4500-NH ₃ D or E (19th). | 4500-N _{org} B or C and 4500- NH ₃ B. 4500-NH ₃ C | 4500-N _{org} B or C-97 and 4500-NH ₃ B- 97. 4500-NH ₃ C-97 (A). | D3590-89, 02 (A). | 973.48 ³ | |
| 32. Lead—Total, ⁴ mg/L | Nesslerization or | | | | | D3590-89, 02 (A). | | |
| | Electrode | | | 4500-NH ₃ D or E. | 4500-NH ₃ D or E-97. | | | |
| | Automated phenate colorimetric. Semi-automated block digester col- orimetric. Manual or block digester potenti- metric. Block digester, fol- lowed by Auto dis- tillation and Titra- tion, or | 351.1 (Rev. 1978) ¹ . 351.2, Rev. 2.0 (1993). | | | | | | I-4551-78 ⁸ I-4515-91 ⁴⁵ |
| | Flow injection gas diffusion. Digestion ⁴ followed by: | | | | | D3590-89, 02 (B). D3590-89, 02 (A). | | See footnote ³⁹ See footnote ⁴⁰ See footnote ⁴¹ |

| | | | | | | |
|--------------------------------------|-------------------------|-------------|-----------|----------------|--|--|
| AA direct aspiration ³⁶ . | | 3111 B or C | | 3111 B or C-99 | D3559-96, 03 (A or B), D3559-96, 03 (D). | 974.27 ³ , I-3399-85 ² , I-4403-89 ⁵¹ |
| AA furnace | | 3113 B | | 3113 B-99 | | |
| STGFAA | 200.9, Rev. 2.2 (1994). | 3120 B | 3120 B | 3120 B-99 | | I-4471-97 ⁵⁰ |
| ICP/AES ³⁶ | 200.7, Rev. 4.4 (1994). | | | | D5673-03 | 993.14 ³ |
| ICP/MS | 200.8, Rev. 5.4 (1994). | | | | D4190-94, 99 (C). | See footnote ³⁴ |
| DCP ³⁶ | | | | | | |
| Voltametry ¹¹ or | | | | | | |
| Colorimetric (Dithionite zone). | | 3500-Pb D | 3500-Pb B | 3500-Pb B-97. | | |
| Digestion ⁴ followed by: | | | | | | |
| AA direct aspiration | | 3111 B | | 3111 B-99 | D511-93, 03(B) | 974.27 ³ , I-3447-85 ² , I-4471-97 ⁵⁰ |
| ICP/AES | 200.7, Rev. 4.4 (1994). | 3120 B | 3120 B | 3120 B-99 | | |
| DCP or | | | | | | See footnote ³⁴ |
| Gravimetric | | 3500-Mg D. | | | D6919-03. | |
| Ion Chromatography | | | | | | |
| Digestion ⁴ followed by: | | | | | | |
| AA direct aspiration ³⁶ . | | 3111 B | | 3111 B-99 | D858-95, 02 (A or B), D858-95, 02 (C). | 974.27 ³ , I-3454-85 ² |
| AA furnace | | 3113 B | | 3113 B-99 | | |
| STGFAA | 200.9, Rev. 2.2 (1994). | 3120 B | 3120 B | 3120 B-99 | | I-4471-97 ⁵⁰ |
| ICP/AES ³⁶ | 200.7, Rev. 4.4 (1994). | | | | D5673-03 | 993.14 ³ |
| ICP/MS | 200.8, Rev. 5.4 (1994). | | | | D4190-94, 99 | See footnote ³⁴ |
| DCP36, or | | | | | | 920.203 ³ |
| Colorimetric (Persulfate), or. | | 3500-Mn D | 3500-Mn B | 3500-Mn B-99 | | |
| (Periodate) | | | | | | |
| Cold vapor, manual or. | 245.1, Rev. 3.0 (1994). | 3112 B | | 3112 B-99 | D3223-97, 02 | See footnote ²³ |
| Automated | 245.2 (Issued 1974). | | | | | 977.22 ³ , I-3462-85 ² |

33. Magnesium—Total,⁴ mg/L.

34. Manganese—Total,⁴ mg/L.

35. Mercury—Total⁴, mg/L.

TABLE IB—LIST OF APPROVED INORGANIC TEST PROCEDURES—Continued

| Parameter | Methodology ³⁸ | Reference (method number or page) | | | | | USGS/AOAC/ other | |
|---|--|---|---------------------------------------|---------------------------------|---------------------------------|--------------------------------|--------------------------------|--|
| | | EPA ^{35, 52} | Standard meth- ods (18th, 19th) | Standard meth- ods (20th) | Standard meth- ods online | ASTM | | |
| 36. Molybdenum—Total ⁴ , mg/L | Cold vapor atomic fluorescence spec- trometry (CVAFS). Purge and Trap CVAFS. Digestion ⁴ followed by: AA direct aspiration AA furnace ICP/AES ICP/MS DCP Digestion ⁴ followed by: AA direct aspira- tion ³⁶ . AA furnace STGFAA ICP/AES ³⁶ ICP/MS DCP ³⁶ , or Colorimetric (heptoxime). Ion Chromatography | 245.7 Rev. 2.0 (2005) ⁵⁹ . 1631E ⁴³ . | | | | | | |
| | | | 3111 D | | 3111 D-99 | | I-3490-85 ² | |
| | | | 3113 B | | 3113 B-99 | | I-3492-96 ⁴⁷ | |
| | | | 3120 B | | 3120 B-99 | | I-4471-97 ⁵⁰ | |
| | | | | | | D5673-03 | 993.14 ³ | |
| | | | | | | | See footnote ³⁴ | |
| | | | 3111 B or C | | 3111 B or C-99 | D1886-90, 94 (98) (A or B). | I-3499-85 ² | |
| | | | 3113 B | | 3113 B-99 | D1886-90, 94 (98) (C). | I-4503-89 ⁵¹ | |
| | | | 3120 B | | 3120 B-99 | | I-4471-97 ⁵⁰ | |
| | | | | | | D5673-03 | 993.14 ³ | |
| 37. Nickel—Total ⁴ mg/L ... | Ion Chromatography | | | 4110 B | 4110 B-00 | D4327-97, 03 | 993.30 ³ | |
| | | | | | | | See footnote ³⁴ | |
| | | | | | | | D6508, Rev. 2 ⁵⁴ | |
| 38. Nitrate (as N), mg/L ... | Colorimetric (heptoxime). Ion Chromatography | 300.0, Rev 2.1 (1993) and 300.1, Rev 1.0 (1997). | 4110 B | | | | | |
| | | | | | | | | |

| | | | | | |
|---|--|---|---|--|---|
| <p>Ion Selective Electrode. Colorimetric (Brucine sulfate), or.</p> | <p>..... 352.11</p> | <p>4500-NO₃-D</p> | <p>4500-NO₃-D</p> | <p>4500-NO₃-D</p> | <p>..... 973.50³, 419D 1,7, p. 28⁹</p> |
| <p>Nitrate-nitrite N minus Nitrite N (See parameters 39 and 40). Cadmium reduction, manual or. Automated, or</p> | <p>.....</p> | <p>4500-NO₃-E ... 4500-NO₃-E ... 4500-NO₃-F ... 4500-NO₃-H ... 4110 B</p> | <p>4500-NO₃-E ... 4500-NO₃-F ... 4500-NO₃-H ... 4110 B</p> | <p>4500-NO₃-E-00 4500-NO₃-F-00 4500-NO₃-H-00. 4110 B-00</p> | <p>..... D3867-99(B). D3867-99(A) ... D4327-97</p> |
| <p>Automated hydrazine Ion Chromatography</p> | <p>353.2, Rev. 2.0 (1993). 300.0, Rev 2.1 (1993) and 300.1, Rev 1.0 (1997).</p> | <p>.....</p> | <p>.....</p> | <p>.....</p> | <p>..... D6508, Rev. 2⁵⁴ See footnote²⁵</p> |
| <p>CIE/UV</p> | <p>.....</p> | <p>4500-NO₂-B</p> | <p>4500-NO₂-B</p> | <p>4500-NO₂-B-00</p> | <p>..... I-4540-85²</p> |
| <p>Spectrophotometric: Manual or. Automated (Diazotization). Automated (*bypass cadmium reduction). Manual (*bypass cadmium reduction).</p> | <p>353.2, Rev. 2.0 (1993).</p> | <p>4500-NO₃-F ... 4500-NO₃-E ...</p> | <p>4500-NO₃-F ... 4500-NO₃-E ...</p> | <p>4500-NO₃-F-00 4500-NO₃-E-00</p> | <p>..... I-4545-85²</p> |
| <p>Ion Chromatography</p> | <p>300.0, Rev 2.1 (1993) and 300.1, Rev 1.0 (1997). 1664A⁴²</p> | <p>4110 B</p> | <p>4110 B</p> | <p>4110 B-00</p> | <p>..... 993.30³</p> |
| <p>CIE/UV</p> | <p>1664A⁴²</p> | <p>.....</p> | <p>.....</p> | <p>5520 B-01³⁸.</p> | <p>..... D6508, Rev.2⁵⁴</p> |
| <p>Hexane extractable material (HEM): n-Hexane extraction and gravimetry. Silica gel treated HEM (SGT-HEM): Silica gel treatment and gravimetry..</p> | <p>1664A⁴².</p> | <p>.....</p> | <p>.....</p> | <p>.....</p> | <p>.....</p> |

39. Nitrate-nitrite (as N), mg/L.

40. Nitrite (as N), mg/L

41. Oil and grease—Total recoverable, mg/L.

TABLE IB—LIST OF APPROVED INORGANIC TEST PROCEDURES—Continued

| Parameter | Methodology ⁵⁸ | Reference (method number or page) | | | | | | USGS/AOAC/ other |
|---|---|---|---------------------------------------|---------------------------------|---------------------------------|--|--|---------------------|
| | | EPA ^{35,52} | Standard meth- ods (18th, 19th) | Standard meth- ods (20th) | Standard meth- ods online | ASTM | | |
| 42. Organic carbon—Total (TOC), mg/L. 43. Organic nitrogen (as N), mg/L. | Combustion or oxida- tion. Total Kjeldahl N (Pa- rameter 31) minus ammonia N (Pa- rameter 4). Ascorbic acid meth- od. Automated, or | | 5310 B, C, or D | 5310 B, C, or D | 5310 B, C, or D— 00. | D2579-93 (A or B). | 973.47, ³ p. 14 ²⁴ | |
| | | 365.1, Rev. 2.0 (1993). | 4500-P F | 4500-P F | | | 973.56 ³ , I- 4601-85 ² 973.55 ³ | |
| 44. Orthophosphate (as P), mg/L. | Manual single rea- gent. Manual two reagent Ion Chromatography | 365.3 (Issued 1978) ¹ . | 4110 B | 4110 B | 4110 B-00 | D4327-97, 03 | 993.30 ³ | |
| | | 300.0, Rev 2.1 (1993) and 300.1, Rev 1.0 (1997). | | | | | D6508, Rev. 2 ⁵⁴ | |
| 45. Osmium—Total ⁴ , mg/ L. | Digestion ⁴ followed by: AA direct aspiration, or. AA furnace | | 3111 D | | 3111 D-99. | | | |
| | | 252.2 (Issued 1978) ¹ . | 4500-O C | 4500-O C | 4500-O C-01 ... | D888-92, 03 (A). D888-92, 03 (B). | 973.4 5B ³ , I- 1575-78 ⁸ I-1576-78 ⁸ | |
| 46. Oxygen, dissolved, mg/L. | Winkler (Azide modi- fication), or. Electrode | | 4500-O G | 4500-O G | 4500-O G-01 ... | | | |
| | | | | | | | | |
| 47. Palladium—Total, ⁴ mg/L. | Digestion ⁴ followed by: AA direct aspiration, or. AA furnace | | 3111 B | | 3111 B-99 | | p. S27 ¹⁰ p. S28 ¹⁰ | |
| | | 253.2 ¹ (Issued 1978). | | | | | | |

| | | | | | | | | | | | | | | | |
|---|--|--|------------------|------------------|----------------|----------------|----------------|----------------|--------------|--------------|--------------|--------------|--------------|------------------|-------|
| 48. Phenols, mg/L | DCP Manual distillation ²⁶ Followed by: Colorimetric (4AAP) manual, or Automated | 420.1 ¹ (Rev. 1978). 420.1 ¹ (Rev. 1978). 420.4 Rev. 1.0 (1993). | | | | | | | | | | | | | |
| 49. Phosphorus (elemental), mg/L. | Gas-liquid chromatography. | | | | | | | | | | | | | | |
| 50. Phosphorus—Total, mg/L. | Persulfate digestion followed by: ²⁰ Manual or | | 4500-P B.5 | 4500-P B.5 | 4500-P E | 4500-P E | 4500-P F | 4500-P F | | | | | | D515-88(A). | |
| | Automated ascorbic acid reduction. | 365.3 ¹ (Issued 1978). | | | | | | | | | | | | | |
| | Semi-automated block digester. | 365.1 Rev. 2.0 (1993). | 4500-P E | 4500-P F | | | | | | | | | | D515-88(B) | |
| 51. Platinum—Total, ⁴ mg/L. | Digestion ⁴ followed by: AA direct aspiration AA furnace | 365.4 ¹ (Issued 1974). | | | | | | | | | | | | | |
| | DCP | | | | | | | | | | | | | | |
| | Digestion ⁴ followed by: AA direct aspiration | 255.2 ¹ | 3111 B | | | | | | | | | | | | |
| 52. Potassium—Total, ⁴ mg/L. | ICP/AES | | | | | | | | | | | | | | |
| | Flame photometric, or. Colorimetric Ion Chromatography | 200.7, Rev. 4.4 (1994). | 3111 B | 3120 B | 3120 B | 3120 B | 3120 B | 3120 B | 3120 B | 3120 B | 3120 B | 3120 B | 3120 B | | |
| 53. Residue—Total, mg/L. | Gravimetric, 103-105° | | 3500-K D | | | | | | | | | | | | |
| 54. Residue—filterable, mg/L. | Gravimetric, 180° | | | | | | | | | | | | | | |
| 55. Residue—non-filterable (TSS), mg/L. | Gravimetric, 103-105 °C post washing of residue. | | | | | | | | | | | | | | |
| 56. Residue—settleable, mg/L. | Volumetric, (Imhoff cone), or gravimetric. | | | | | | | | | | | | | | |
| 57. Residue—Volatile, mg/L. | Gravimetric, 550 °C | 160.4 ¹ | | | | | | | | | | | | | |

TABLE IB—LIST OF APPROVED INORGANIC TEST PROCEDURES—Continued

| Parameter | Methodology ³⁸ | Reference (method number or page) | | | | | USGS/AOAC/ other |
|--|--|-----------------------------------|---------------------------------------|---------------------------------|---------------------------------|----------------------|-------------------------|
| | | EPA ^{35,52} | Standard meth- ods (18th, 19th) | Standard meth- ods (20th) | Standard meth- ods online | ASTM | |
| 58. Rhodium—Total, ⁴ mg/ L. | Digestion ⁴ followed by: AA direct aspiration, | | 3111 B | | 3111 B-99. | | |
| | or: AA furnace | 265.2 ¹ . | | | | | |
| 59. Ruthenium—Total, ⁴ mg/L. | Digestion ⁴ followed by: | | 3111 B | | 3111 B-99. | | |
| | AA direct aspiration, or: AA furnace | 267.2 ¹ . | | | | | |
| 60. Selenium—Total, ⁴ mg/ L. | Digestion ⁴ followed by: | | 3113 B | | 3113 B-99 | D3859-98, 03 (B). | I-4668-98 ⁴⁹ |
| | AA furnace | 200.9, Rev. 2.2 (1994). | | | 3120 B-99. | | |
| 61. Silica—Dissolved, ³⁷ mg/L. | ICP/AES ³⁶ | 200.7, Rev. 4.4 (1994). | 3120 B | 3120 B | | D5673-03 | 993.14 ³ |
| | ICP/MS | 200.8, Rev. 5.4 (1994). | | | | | |
| 62. Silver—Total, ^{4,31} mg/ L. | AA gaseous hydride | | 3114 B | | 3114 B-97 | D3859-98, 03 (A). | I-3667-85 ² |
| | 0.45 micron filtration followed by: Colorimetric, Manual or: Automated (Molybdosilicate), or: ICP/AES | 200.7, Rev. 4.4 (1994). | 4500-Si D | 4500-SiO ₂ C .. | 4500-SiO ₂ C-97 | | |
| 62. Silver—Total, ^{4,31} mg/ L. | Digestion ^{4,29} fol- lowed by: AA direct aspiration | | 3120 B | 3120 B | 3120 B-99 | | I-4471-97 ⁵⁰ |
| | | | 3111 B or C .. | | 3111 B or C-99 | | |

| | | | | | | |
|---|---|---|---|-------|-------------------------------------|---|
| AA furnace STGFAA | 200.9, Rev. 2.2 (1994). | 3113 B | 3113 B-99 | | | I-4724-89 ⁵¹ |
| ICP/AES | 200.7, Rev. 4.4 (1994). | 3120 B | 3120 B-99 | | | I-4471-97 ⁵⁰ |
| ICP/MS | 200.8, Rev. 5.4 (1994). | | | | D5673-03 | 993.14 ³ |
| DCP Digestion ⁴ followed by: AA direct aspiration | | | | | | See footnote ³⁴ |
| ICP/AES | 200.7, Rev. 4.4 (1994). | 3111 B | 3111 B-99 | | | 973.54 ³ , I- 3735-85 ² I-4471-97 ⁵⁰ |
| DCP, or Flame photometric Ion Chromatography | | 3120 B | 3120 B-99 | | | See footnote ³⁴ |
| Wheatstone bridge | | 3500-Na D | 3500-Na B-97. | | | |
| Automated colorimetric. | 120.1 ¹ (Rev. 1982). | 2510 B | 2510 B-97 | | D 6919-03, D1125-95 (99) (A). | 973.40 ³ , I- 2781-85 ² |
| Gravimetric | 375.2, Rev. 2.0 (1993). | 4500-SO ₄ ²⁻ C or D. | 4500-SO ₄ ²⁻ C or D. | | | 925.54 ³ |
| Turbidimetric Ion Chromatography | 300.0, Rev 2.1 (1993) and 300.1, Rev 1.0 (1997). | 4110 B | 4110 B-00 | | D516-90, 02 ... D4327-97, 03 | 426C ³⁰ 993.30 ³ |
| CIE/UV | | | | | | D6508, Rev. 2 ⁵⁴ |
| Titrimetric (iodine), or | | 4500-S ²⁻ F (19th) 4500- S ²⁻ E (18th). | 4500-S ²⁻ F-00 | | | I-3840-85 ² |
| Colorimetric (methy- ylene blue). | | 4500-S ²⁻ D | 4500-S ²⁻ D-00. | | | |
| Ion Selective Elec- trode. | | 4500-S ²⁻ G | 4500-S ²⁻ G-00 | | D4658-03. | |
| Titrimetric (iodine- iodate). | | 4500-SO ₃ ²⁻ B | 4500-SO ₃ ²⁻ B- 00. | | | |
| Colorimetric (meth- ylene blue). | | 5540 C | 5540 C-00 | | D2330-88, 02. | |
| Thermometric Digestion ⁴ followed by: | | 2550 B | 2550 B-00 | | | See footnote ³² |

63. Sodium—Total,⁴ mg/L

64. Specific conductance,
micromhos/cm at 25 °C.

65. Sulfate (as SO₄), mg/L

66. Sulfide (as S), mg/L ...

67. Sulfite (as SO₃), mg/L

68. Surfactants, mg/L

69. Temperature, °C

70. Thallium—Total,⁴ mg/L

TABLE IB—LIST OF APPROVED INORGANIC TEST PROCEDURES—Continued

| Parameter | Methodology ⁵⁸ | Reference (method number or page) | | | | | USGS/AOAC/ other |
|---|--|-------------------------------------|---------------------------------------|---------------------------------|---------------------------------|-----------------|--|
| | | EPA ^{35,52} | Standard meth- ods (18th, 19th) | Standard meth- ods (20th) | Standard meth- ods online | ASTM | |
| 71. Tin—Total, ⁴ mg/L | AA direct aspiration AA furnace | 279.21 (Issued 1978). | 3111 B | | 3111 B-99. | | |
| | STGFAA | 200.9, Rev. 2.2 (1994). | | | | | |
| | ICP/AES | 200.7, Rev. 4.4 (1994). | 3120 B | 3120 B | 3120 B-99. | D5673-03 | 993.14 ³ |
| | ICP/MS | 200.8, Rev. 5.4 (1994). | | | | | |
| | Digestion ⁴ followed by: AA direct aspiration AA furnace, or STGFAA | 200.9, Rev. 2.2 (1994). | 3111 B | | | 3111 B-99 | I-3850-78 ⁸ |
| 72. Titanium—Total, ⁴ mg/ L | ICP/AES | 200.7, Rev. 4.4 (1994). | 3113 B | | 3113 B-99. | | |
| | Digestion ⁴ followed by: AA direct aspiration AA furnace | 283.21 (Issued 1978). | 3111 D | | 3111 D-99. | | |
| 73. Turbidity, NTU ⁵⁹ | DCP | 180.1, Rev. 2.0 (1993). | 2130 B | 2130 B | 2130 B-01 | D1889-94, 00 | See footnote ³⁴ I-3860-85 ² |
| | Nephelometric | | | | | | |
| 74. Vanadium—Total, ⁴ mg/L | Digestion ⁴ followed by: AA direct aspiration AA furnace | 200.7, Rev. 4.4 (1994). | 3111 D | | 3111 D-99. | D3373-93, 03. | I-4471-97 ⁵⁰ |
| | ICP/AES | 200.8, Rev. 5.4 (1994). | 3120 B | 3120 B | 3120 B-99 | D5673-03 | 993.14 ³ |
| | ICP/MS | | | | | D4190-94, 99 | See footnote ³⁴ |
| | DCP, or Colorimetric (Gallic Acid) | | 3500-V D | 3500-V B | 3500-V B-97. | | |

| 75. Zinc—Total ⁴ , mg/L | Digestion ⁴ followed by: AA direct aspiration ³⁶ | 3111 B or C | 3111 B or C—99 | D1691—95, 02 (A or B) | 974.27 ³ , p. 37 ⁹ , I-3900—85 ² |
|--|---|-------------------|-------------------------------|-----------------------------|---|
| | 289.2 ¹ (Issued 1978) | | | | |
| | 200.7, Rev. 4.4 (1994) | 3120 B | 3120 B—99 ⁸⁹ | | I-4471—97 ⁵⁰ |
| | 200.8, Rev. 5.4 (1994) | | | D5673—03 | 993.14 ³ |
| | | 3500—Zn E | | D4190—94, 99 | See footnote ³⁴ |
| | | 3500—Zn F | | | |
| | | | 3500—Zn B—97 | | See footnote ³³ |

Table 1B Notes:

¹“Methods for Chemical Analysis of Water and Wastes,” Environmental Protection Agency, Environmental Monitoring Systems Laboratory—Cincinnati (EMSL—CI), EPA-600/4-79-020 (NTIS PB 84-128677), Revised March 1983 and 1979 where applicable.

²Fishman, M. J., et al. “Methods for Analysis of Inorganic Substances in Water and Fluvial Sediments,” U.S. Department of the Interior, Techniques of Water-Resource Investigations of the U.S. Geological Survey, Denver, CO, Revised 1989, unless otherwise stated.

³“Official Methods of Analysis of the Association of Official Analytical Chemists,” Methods Manual, Sixteenth Edition, 4th Revision, 1998.

⁴For the determination of total metals (which are equivalent to total recoverable metals) the sample is not filtered before processing. A digestion procedure is required to solubilize analytes in suspended material and to break down organic-metal complexes (to convert the analyte to a detectable form for colorimetric analysis). For non-plateform graphite furnace atomic absorption determinations a digestion using nitric acid (as specified in Section 4.1.3 of Methods for the Chemical Analysis of Water and Wastes) is required prior to analysis. The procedure used should subject the sample to gentle, acid refluxing and at no time should the sample be taken to dryness. For direct aspiration flame atomic absorption determinations (FLAA) a combination acid (nitric and hydrochloric acids) digestion is preferred prior to analysis. The approved total recoverable digestion is described as Method 200.2 in Supplement I of “Methods for the Determination of Metals in Environmental Samples” EPA/600/R-94/111, May, 1994, and is reproduced in EPA Methods 200.7, 200.8, and 200.9 from the same Supplement. However, when using the gaseous hydride technique or for the determination of certain elements such as antimony, arsenic, selenium, silver, and tin by non-EPA graphite furnace atomic absorption methods, mercury by cold vapor atomic absorption, the noble metals and titanium by FLAA, a specific or modified digestion procedure may be required and in all cases the referenced method write-up should be consulted for specific instruction and/or cautions. For analyses using inductively coupled plasma-atomic emission spectrometry (ICP-AES), the direct current plasma (DCP) technique or the EPA spectrochemical techniques (platform furnace AA, ICP-AES, and ICP-MS) use EPA Method 200.2 or an approved alternate procedure (e.g., CEM microwave digestion, which may be used with certain analytes as indicated in Table 1B); the total recoverable digestion procedures in EPA Methods 200.7, 200.8, and 200.9 may be used for those respective methods. Regardless of the digestion procedure, the results of the analysis after digestion procedure are reported as “total” metals.

⁵Copper sulfate may be used in place of mercuric sulfate.

⁶Manual distillation is not required if comparability data on representative effluent samples are on file to show that this preliminary distillation step is not necessary; however, manual distillation will be required to resolve any controversies.

⁷Ammonia, Automated Electrode Method, Industrial Method Number 379-75 WE, dated February 19, 1976, Bran & Luebbe (Technicon) Auto Analyzer II, Bran & Luebbe Analyzing Technologies, Inc., Elmford, NY 10523.

⁸The approved method is that cited in “Methods for Determination of Inorganic Substances in Water and Fluvial Sediments”, USGS TWRI, Book 5, Chapter A1 (1979).

⁹American National Standard on Photographic Processing Effluents, April 2, 1975. Available from ANSI, 25 West 43rd st., New York, NY 10036.

¹⁰“Selected Analytical Methods Approved and Cited by the United States Environmental Protection Agency,” Supplement to the Fifteenth Edition of *Standard Methods for the Examination of Water and Wastewater* (1981).

¹¹The use of normal and differential pulse voltage ramps to increase sensitivity and resolution is acceptable.

- ¹² Carbonaceous biochemical oxygen demand (CBOD₅) must not be confused with the traditional BOD₅ test method which measures "total BOD." The addition of the nitrification inhibitor is not a procedural option, but must be included to report the CBOD₅ parameter. A discharger whose permit requires reporting the traditional BOD₅ may not use a nitrification inhibitor in the procedure for reporting the results. Only when a discharger's permit specifically states CBOD₅ is required can the permittee report data using a nitrification inhibitor.
- ¹³ OIC Chemical Oxygen Demand Method, Oceanography International Corporation, 1978, 512 West Loop, P.O. Box 2980, College Station, TX 77840.
- ¹⁴ Chemical Oxygen Demand, Method 8000, Hach Handbook of Water Analysis, 1979, Hach Chemical Company, P.O. Box 389, Loveland, CO 80537.
- ¹⁵ The back titration method will be used to resolve controversy.
- ¹⁶ Orion Research Instruction Manual, Residual Chlorine Electrode Model 97-70, 1977, Orion Research Incorporated, 840 Memorial Drive, Cambridge, MA 02138. The calibration graph for the Orion residual chlorine method must be derived using a reagent blank and three standard solutions, containing 0.2, 1.0, and 5.0 mL 0.00281 N potassium iodate/100 mL solution, respectively.
- ¹⁷ The approved method is that cited in *Standard Methods for the Examination of Water and Wastewater*, 14th Edition, 1976.
- ¹⁸ National Council of the Paper Industry for Air and Stream Improvement, Inc., Technical Bulletin 253, December 1971.
- ¹⁹ Copper, Biocinchonate Method, Method 8506, Hach Handbook of Water Analysis, 1979, Hach Chemical Company, P.O. Box 389, Loveland, CO 80537.
- ²⁰ When using a method with block digestion, this treatment is not required.
- ²¹ Hydrogen ion (pH) Automated Electrode Method, Industrial Method Number 378-75WA, October 1976, Bran & Luebbe (Technicon) Autoanalyzer II. Bran & Luebbe Analyzing Technologies, Inc., Elmsford, NY 10523.
- ²² Iron, 1,10-Phenanthroline Method, Method 8008, 1980, Hach Chemical Company, P.O. Box 389, Loveland, CO 80537.
- ²³ Manganese, Periodate Oxidation Method, Method 8034, Hach Handbook of Wastewater Analysis, 1979, pages 2-113 and 2-117, Hach Chemical Company, Loveland, CO 80537.
- ²⁴ Wershaw, R. L., et al., "Methods for Analysis of Organic Substances in Water," Techniques of Water-Resources Investigation of the U.S. Geological Survey, Book 5, Chapter A3, (1972 Revised 1987) p. 14.
- ²⁵ Nitrogen, Nitrite, Method 8507, Hach Chemical Company, P.O. Box 389, Loveland, CO 80537.
- ²⁶ Just prior to distillation, adjust the sulfuric-acid-preserved sample to pH 4 with 1 + 9 NaOH.
- ²⁷ The approved method is cited in *Standard Methods for the Examination of Water and Wastewater*, 14th Edition. The colorimetric reaction is conducted at a pH of 10.0±0.2. The approved methods are given on pp 576-81 of the 14th Edition: Method 510A for distillation, Method 510B for the manual colorimetric procedure, or Method 510C for the manual spectrometric procedure.
- ²⁸ R.F. Addison, and R. G. Ackman, "Direct Determination of Elemental Phosphorus by Gas-Liquid Chromatography," *Journal of Chromatography*, Vol. 47, No.3, pp. 421-426, 1970.
- ²⁹ Approved methods for the analysis of silver in industrial wastewaters at concentrations of 1 mg/L and above are inadequate where silver exists as an inorganic halide. Silver halides such as the bromide and chloride are relatively insoluble in reagents such as nitric acid but are readily soluble in an aqueous buffer of sodium thiosulfate and sodium hydroxide to pH of 12. Therefore, for levels of silver above 1 mg/L, 20 mL of sample should be diluted to 100 mL by adding 40 mL each of 2 M Na₂S₂O₃ and NaOH. Standards should be prepared in the same manner. For levels of silver below 1 mg/L the approved method is satisfactory.
- ³⁰ The approved method is that cited in *Standard Methods for the Examination of Water and Wastewater*, 15th Edition.
- ³¹ For samples known or suspected to contain high levels of silver (e.g., in excess of 4 mg/L), cyanogen iodide should be used to keep the silver in solution for analysis. Prepare a cyanogen iodide solution by adding 4.0 mL of concentrated NH₄OH, 6.5 g of KCN, and 5.0 mL of a 1.0 N solution of I₂ to 50 mL of reagent water in a volumetric flask and dilute to 100.0 mL. After digestion of the sample, adjust the pH of the digestate to >7 to prevent the formation of HCN under acidic conditions. Add 1 mL of the cyanogen iodide solution to the sample digestate and adjust the volume to 100 mL with reagent water (NOT acid). If cyanogen iodide is added to sample digestates, then silver standards must be prepared that contain cyanogen iodide as well. Prepare working standards by diluting a small volume of a silver stock solution with water and adjusting the pH>7 with NH₄OH. Add 1 mL of the cyanogen iodide solution and let stand 1 hour. Transfer to a 100-mL volumetric flask and dilute to volume with water.
- ³² Stevens, H.H., Ficke, J. F., and Smoot, G. F., "Water Temperature—Influent Factors, Field Measurement and Data Presentation," Techniques of Water-Resources Investigations of the U.S. Geological Survey, Book 1, Chapter D1, 1975.
- ³³ Zinc, Zincin Method, Method 8009, Hach Handbook of Water Analysis, 1979, pages 2-231 and 2-333, Hach Chemical Company, Loveland, CO 80537.
- ³⁴ "Direct Current Plasma (DCP) Optical Emission Spectrometric Method for Trace Elemental Analysis of Water and Wastes, Method AES0029," 1986—Revised 1991, Thermo Jarrell Ash Corporation, 27 Forge Parkway, Franklin, MA 02038.
- ³⁵ Precision and recovery statements for the atomic absorption direct aspiration and graphite furnace methods, and for the spectrophotometric SDCC method for arsenic are provided in Appendix D of this part titled, "Precision and Recovery Statements for Methods for Measuring Metals."
- ³⁶ Microwave-assisted digestion may be employed for this metal, when analyzed by this methodology. "Closed Vessel Microwave Digestion of Wastewater Samples for Determination of Metals", CEM Corporation, P.O. Box 200, Matthews, NC 28106-0200, April 16, 1992. Available from the CEM Corporation.
- ³⁷ When determining boron and silica, only plastic, PTFE, or quartz laboratory ware may be used from start until completion of analysis.

- ³⁸ Only use n-hexane extraction solvent when determining Oil and Grease parameters—Hexane Extractable Material (HEM), or Silica Gel Treated HEM (analogous to EPA Method 1664A). Use of other extraction solvents (e.g., those in the 18th and 19th editions) is prohibited.
- ³⁹ Nitrogen, Total Kjeldahl, Method PAI-DK01 (Block Digestion, Steam Distillation, Titrimetric Detection), revised 12/22/94, OI Analytical/ALPKEM, P.O. Box 9010, College Station, TX 77842.
- ⁴⁰ Nitrogen, Total Kjeldahl, Method PAI-DK02 (Block Digestion, Steam Distillation, Colorimetric Detection), revised 12/22/94, OI Analytical/ALPKEM, P.O. Box 9010, College Station, TX 77842.
- ⁴¹ Nitrogen, Total Kjeldahl, Method PAI-DK03 (Block Digestion, Automated FIA Gas Diffusion), revised 12/22/94, OI Analytical/ALPKEM, P.O. Box 9010, College Station, TX 77842.
- ⁴² Method 1664, Revision A "n-Hexane Extractable Material (HEM: Oil and Grease) and Silica Gel Treated n-Hexane Extractable Material (SGT-HEM: Non-polar Material) by Extraction and Gravimetry" EPA-821-R-98-002, February 1999. Available at NTIS, PB-121949, U.S. Department of Commerce, 5285 Port Royal, Springfield, VA 22161.
- ⁴³ USEPA, 2001. Method 1631, Revision E, "Mercury in Water by Oxidation, Purge and Trap, and Cold Vapor Atomic Fluorescence Spectrometry," September 2002, Office of Water, U.S. Environmental Protection Agency (EPA-821-R-02-024). The application of clean techniques described in EPA's draft Method 1669: *Sampling Ambient Water for Trace Metals at EPA Water Quality Criteria Levels* (EPA-821-R-96-011) are recommended to preclude contamination at low-level, trace metal determinations.
- ⁴⁴ Available Cyanide, Method OIA-1677, "Available Cyanide by Flow Injection, Ligand Exchange, and Amperometry," ALPKEM, A Division of OI Analytical, P.O. Box 9010, College Station, TX 77842-9010.
- ⁴⁵ "Methods of Analysis by the U.S. Geological Survey National Water Quality Laboratory—Determination of Ammonia Plus Organic Nitrogen by a Kjeldahl Digestion Method," Open File Report (OFR) 00-170.
- ⁴⁶ "Methods of Analysis by the U.S. Geological Survey National Water Quality Laboratory—Determination of Chromium in Water by Graphite Furnace Atomic Absorption Spectrophotometry," Open File Report (OFR) 93-449.
- ⁴⁷ "Methods of Analysis by the U.S. Geological Survey National Water Quality Laboratory—Determination of Molybdenum by Graphite Furnace Atomic Absorption Spectrophotometry," Open File Report (OFR) 97-198.
- ⁴⁸ "Methods of Analysis by the U.S. Geological Survey National Water Quality Laboratory—Determination of Total Phosphorus by Kjeldahl Digestion Method and an Automated Colorimetric Finish That Includes Dialysis," Open File Report (OFR) 92-146.
- ⁴⁹ "Methods of Analysis by the U.S. Geological Survey National Water Quality Laboratory—Determination of Arsenic and Selenium in Water and Sediment by Graphite Furnace-Atomic Absorption Spectrometry," Open File Report (OFR) 98-639.
- ⁵⁰ "Methods of Analysis by the U.S. Geological Survey National Water Quality Laboratory—Determination of Elements in Whole-water Digests Using Inductively Coupled Plasma-Optical Emission Spectrometry and Inductively Coupled Plasma-Mass Spectrometry," Open File Report (OFR) 98-165.
- ⁵¹ "Methods of Analysis by the U.S. Geological Survey National Water Quality Laboratory—Determination of Inorganic and Organic Constituents in Water and Fluvial Sediment," Open File Report (OFR) 93-125.
- ⁵² All EPA methods, excluding EPA Method 300.1, are published in "Methods for the Determination of Metals in Environmental Samples," Supplement I, National Exposure Risk Laboratory-Cincinnati (NERL-CI), EPA/600/R-94/111, May 1994; and "Methods for the Determination of Inorganic Substances in Environmental Samples," NERL-CI, EPA/600/R-93/100, August, 1993. EPA Method 300.1 is available from <http://www.epa.gov/safewater/methods/pdfs/mel300.pdf>.
- ⁵³ Styrene divinyl benzene beads (e.g., AMCO-AEPA-1 or equivalent) and stabilized formazin (e.g., Hach StabiCal™ or equivalent) are acceptable substitutes for formazin.
- ⁵⁴ Method D6508, Rev. 2, "Test Method for Determination of Dissolved Inorganic Anions in Aqueous Matrices Using Capillary Ion Electrophoresis and Chromate Electrolyte," available from Waters Corp, 34 Maple St., Milford, MA, 01757, Telephone: 508/482-2131, Fax: 508/482-3625.
- ⁵⁵ Kelada-01, "Kelada Automated Test Methods for Total Cyanide, Acid Dissociable Cyanide, and Thiocyanate," EPA 821-B-01-009, Revision 1.2, August 2001, National Technical Information Service (NTIS), 5285 Port Royal Road, Springfield, VA 22161 [Order Number PB 2001-108275]. The toll free telephone number is: 800-553-6847. Note: A 450-W UV lamp may be used in this method instead of the 550-W lamp specified if it provides performance within the quality control (QC) acceptance criteria of the method in a given instrument. Similarly, modified flow cell configurations and flow conditions may be used in the method, provided that the QC acceptance criteria are met.
- ⁵⁶ QuikChem Method 10-204-00-1-X, "Digestion and Distillation of Total Cyanide in Drinking and Wastewaters using MICRO DIST and Determination of Cyanide by Flow Injection Analysis," is available from Lachat Instruments 6645 W. Mill Road, Milwaukee, WI 53218, Telephone: 414-358-4200.
- ⁵⁷ When using sulfide removal test procedures described in Method 335.4, reconstitute particulate that is filtered with the sample prior to distillation.
- ⁵⁸ Unless otherwise stated, if the language of this table specifies a sample digestion and/or distillation "followed by" analysis with a method, approved digestion and/or distillation are required prior to analysis.
- ⁵⁹ Method 245.7, Rev. 2.0, "Mercury in Water by Cold Vapor Atomic Fluorescence Spectrometry," February 2005, EPA-821-R-05-001, available from the U.S. EPA Sample Control Center (operated by CSC), 6101 Stevenson Avenue, Alexandria, VA 22304, Telephone: 703-461-2100, Fax: 703-461-8056.

⁶⁰The use of EDTA may decrease method sensitivity in some samples. Analysis may omit EDTA provided that all method specified quality control acceptance criteria are met.
⁶¹Samples analyzed for available cyanide using Methods OIA-1677 or D6888-04 that contain particulate matter may be filtered only after the ligand exchange reagents have been added to the samples, because the ligand exchange process converts complexes containing available cyanide to free cyanide, which is not removed by filtration. Analysis are further cautioned to limit the time between the addition of the ligand exchange reagents and sample analysis to no more than 30 minutes to preclude settling of materials in samples.

TABLE IC—LIST OF APPROVED TEST PROCEDURES FOR NON-PESTICIDE ORGANIC COMPOUNDS

| Parameter ¹ | EPA method number ^{2,7} | | | | Other approved methods | | |
|----------------------------|----------------------------------|-----------------------------|-------|--|-------------------------|---------------------|---|
| | GC | GC/MS | HPLC | Standard Methods [Edition(s)] | Standard Methods Online | ASTM | Other |
| 1. Acenaphthene | 610 | 625, 1625B | 610 | 6440 B [18th, 19th, 20th]. | | D4657-92 (99) | See footnote ⁹ , p. 27 |
| 2. Acenaphthylene | 610 | 625, 1625B | 610 | 6410 B, 6440 B, [18th, 19th, 20th]. | 6410 B-00 | D4657-92 (99) | See footnote ⁹ , p. 27 |
| 3. Acrolein | 603 | 624 ⁴ , 1624B. | 610 | 6410 B, 6440 B [18th, 19th, 20th]. | 6410 B-00 | D4657-92 (99) | See footnote ⁹ , p. 27 |
| 4. Acrylonitrile | 603 | 624 ⁴ , 1624B. | | 6200 B [20th] and 6210 B | 6200 B and C-97. | | |
| 5. Anthracene | 610 | 625, 1625B | | [18th, 19th], 6200 C [20th] and 6220 B | | | |
| 6. Benzene | 602 | 624, 1624B | | [18th, 19th]. | | | |
| 7. Benzidine | | 625 ⁵ , 1625B .. | 605 | | | | See footnote ⁹ , p.1 |
| 8. Benzo(a)anthracene .. | 610 | 625, 1625B | 610 | 6410 B, 6440 B [18th, 19th, 20th]. | 6410 B-00 | D4657-92 (99) | See footnote ⁹ , p. 27 |
| 9. Benzo(a)pyrene | 610 | 625, 1625B | 610 | 6410 B, 6440 B [18th, 19th, 20th]. | 6410 B-00 | D4657-92 (99) | See footnote ⁹ , p. 27 |
| 10. Benzo(b)fluoranthene | 610 | 625, 1625B | 610 | 6410 B, 6440 B [18th, 19th, 20th]. | 6410 B-00 | D4657-92 (99) | See footnote ⁹ , p. 27 |
| 11. Benzo(g,h,i) perylene | 610 | 625, 1625B | 610 | 6410 B, 6440 B [18th, 19th, 20th]. | 6410 B-00 | D4657-92 (99) | See footnote ⁹ , p. 27 |
| 12. Benzo(k) fluoranthene | 610 | 625, 1625B | 610 | 6410 B, 6440 B [18th, 19th, 20th]. | 6410 B-00 | D4657-92 (99) | See footnote ⁹ , p. 27 |
| 13. Benzyl chloride | | | | | | | See footnote ⁹ , p. 130; See footnote ⁶ , p. S102 |
| 14. Benzyl butyl phthalate | 606 | 625, 1625B | | 6410 B [18th, 19th, 20th]. | 6410 B-00 | | See footnote ⁹ , p. 27 |

| | | | | | |
|----------------------------------|----------|------------|--|-----------------------|------------------------------------|
| 15. Bis(2-chloroethoxy) methane. | 611 | 625, 1625B | 6410 B [18th, 19th, 20th]. | 6410 B-00 | See footnote ⁹ , p. 27 |
| 16. Bis(2-chloroethyl) ether. | 611 | 625, 1625B | 6410 B [18th, 19th, 20th]. | 6410 B-00 | See footnote ⁹ , p. 27 |
| 17. Bis(2-ethylhexyl) phthalate. | 606 | 625, 1625B | 6410 B [18th, 19th, 20th]. | 6410 B-00 | See footnote ⁹ , p. 27 |
| 18. Bromodichloro-methane. | 601 | 624, 1624B | 6200 C [20th] and 6230 B [18th, 19th], 6200 B [20th] and 6210 B [18th, 19th]. | 6200 B and C-97. | |
| 19. Bromoform | 601 | 624, 1624B | 6200 C [20th] and 6230 B [18th, 19th], 6200 B [20th] and 6210 B [18th, 19th]. | 6200 B and C-97. | |
| 20. Bromomethane | 601 | 624, 1624B | 6200 C [20th] and 6230 B [18th, 19th], 6200 B [20th] and 6210 B [18th, 19th]. | 6200 B and C-97. | |
| 21. 4-Bromophenyl phenyl ether. | 611 | 625, 1625B | 6410 B [18th, 19th, 20th]. | 6410 B-00 | See footnote ⁹ , p. 27 |
| 22. Carbon tetrachloride | 601 | 624, 1624B | 6200 C [20th] and 6230 B [18th, 19th]. | 6200 C-97 | See footnote ⁹ , p. 130 |
| 23. 4-Chloro-3-methyl phenol. | 604 | 625, 1625B | 6410 B, 6420 B [18th, 19th, 20th]. | 6410 B-00, 6420 B-00. | See footnote ⁹ , p. 27 |
| 24. Chlorobenzene | 601, 602 | 624, 1624B | 6210 B [18th, 19th], 6200 C [20th] and 6220 B [18th, 19th], 6200 C [20th] and 6230 B [18th, 19th]. | 6200 B and C-97 | See footnote ⁹ , p. 130 |
| 25. Chloroethane | 601 | 624, 1624B | 6200 B [20th] and 6210 B [18th, 19th], 6200 C [20th] and 6230 B [18th, 19th]. | 6200 B and C-97. | |

TABLE IC—LIST OF APPROVED TEST PROCEDURES FOR NON-PESTICIDE ORGANIC COMPOUNDS—Continued

| Parameter ¹ | EPA method number ^{2,7} | | | Other approved methods | | |
|----------------------------------|----------------------------------|------------|-------|---|-----------------------|------------------------------------|
| | GC | GC/MS | HPLC | Standard Methods Online | ASTM | Other |
| 26. 2-Chloroethylvinyl ether. | 601 | 624, 1624B | | 6200 B and C-97. | | See footnote ³ , p. 130 |
| 27. Chloroform | 601 | 624, 1624B | | 6200 B and C-97 | | See footnote ³ , p. 130 |
| 28. Chloromethane | 601 | 624, 1624B | | 6200 B [20th] and 6210 B [18th, 19th], 6200 C [20th] and 6230 B [18th, 19th]. | 6200 B and C-97. | |
| 29. 2-Chloronaphthalene | 612 | 625, 1625B | | 6200 B [20th] and 6210 B [18th, 19th], 6200 C [20th] and 6230 B [18th, 19th]. | 6410 B-00 | See footnote ⁹ , p. 27 |
| 30. 2-Chlorophenol | 604 | 625, 1625B | | 6410 B, 6420 B [18th, 19th, 20th]. | 6410 B(00, 6420 B-00. | See footnote ⁹ , p. 27 |
| 31. 4-Chlorophenyl phenyl ether. | 611 | 625, 1625B | | 6410 B [18th, 19th, 20th]. | 6410 B-00 | See footnote ⁹ , p. 27 |
| 32. Chrysene | 610 | 625, 1625B | 610 | 6410 B, 6440 B [18th, 19th, 20th]. | D4657-92 (99) | See footnote ⁹ , p. 27 |
| 33. Dibenz(a,h)anthracene. | 610 | 625, 1625B | 610 | 6410 B, 6440 B [18th, 19th, 20th]. | D4657-92 (99) | See footnote ⁹ , p. 27 |
| 34. Dibromochloromethane. | 601 | 624, 1624B | | 6200 B [20th] and 6210 B [18th, 19th], 6200 C [20th] and 6230 B [18th, 19th]. | 6200 B and C-97. | See footnote ⁹ , p. 27 |
| 35. 1,2-Dichlorobenzene | 601, 602 | 624, 1625B | | 6200 C [20th] and 6220 B [18th, 19th], 6200 C [20th] and 6230 B [18th, 19th]. | 6200 C-97 | See footnote ⁹ , p. 27 |

| | | | | | |
|-------------------------------|----------|------------|---|-----------------------|-----------------------|
| 36. 1,3-Dichloro-benzene | 601, 602 | 624, 1625B | 6200 C [20th] and 6220 B [18th, 19th], 6200 C [20th] and 6230 B [18th, 19th]. | 6200 C-97 | See footnote 9, p. 27 |
| 37. 1,4-Dichloro-benzene | 601, 602 | 624, 1625B | 6220 B [18th, 19th], 6200 C [20th] and 6230 B [18th, 19th]. | 6200 C-97 | See footnote 9, p. 27 |
| 38. 3,3-Dichloro-benzidine. | | 625, 1625B | 6410 B [18th, 19th, 20th]. | 6410 B-00. | |
| 39. Dichlorodifluoro-methane. | 601 | | 6200 C [20th] and 6230 B [18th, 19th]. | 6200 C-97. | |
| 40. 1,1-Dichloroethane | 601 | 624, 1624B | 6200 B [20th] and 6210 B [18th, 19th], 6200 C [20th] and 6230 B [18th, 19th]. | 6200 B and C-97. | |
| 41. 1,2-Dichloroethane | 601 | 624, 1624B | 6200 B [20th] and 6210 B [18th, 19th], 6200 C [20th] and 6230 B [18th, 19th]. | 6200 B and C-97. | |
| 42. 1,1-Dichloroethene | 601 | 624, 1624B | 6200 B [20th] and 6210 B [18th, 19th], 6200 C [20th] and 6230 B [18th, 19th]. | 6200 B and C-97. | |
| 43. trans-1,2-Dichloroethene. | 601 | 624, 1624B | 6200 B [20th] and 6210 B [18th, 19th], 6200 C [20th] and 6230 B [18th, 19th]. | 6200 B and C-97. | |
| 44. 2,4-Dichlorophenol | 604 | 625, 1625B | 6410 B, 6420 B [18th, 19th, 20th]. | 6410 B-00, 6420 B-00. | See footnote 9, p. 27 |
| 45. 1,2-Dichloro-propane | 601 | 624, 1624B | 6200 B [20th] and 6210 B [18th, 19th], 6200 C [20th] and 6230 B [18th, 19th]. | 6200 B and C-97. | |

TABLE IC—LIST OF APPROVED TEST PROCEDURES FOR NON-PESTICIDE ORGANIC COMPOUNDS—Continued

| Parameter ¹ | EPA method number ^{2,7} | | | | Other approved methods | | |
|---------------------------------|----------------------------------|------------|-------|---|-------------------------|---------------|---|
| | GC | GC/MS | HPLC | Standard Methods [Edition(s)] | Standard Methods Online | ASTM | Other |
| 46. cis-1,3-Dichloro-propene. | 601 | 624, 1624B | | 6200 B [20th] and 6210 B [18th, 19th], 6200 C [20th] and 6230 B [18th, 19th]. | 6200 B and C-97. | | |
| 47. trans-1,3-Dichloro-propene. | 601 | 624, 1624B | | 6200 B [20th] and 6210 B [18th, 19th], 6200 C [20th] and 6230 B [18th, 19th]. | 6200 B and C-97. | | |
| 48. Diethyl phthalate | 606 | 625, 1625B | | 6410 B [18th, 19th, 20th]. | 6410 B-00 | | See footnote ⁹ , p. 27 |
| 49. 2,4-Dimethylphenol | 604 | 625, 1625B | | 6410 B, 6420 B [18th, 19th, 20th]. | 6410 B-00, 6420 B-00. | | See footnote ⁹ , p. 27 |
| 50. Dimethyl phthalate | 606 | 625, 1625B | | 6410 B [18th, 19th, 20th]. | 6410 B-00 | | See footnote ⁹ , p. 27 |
| 51. Di-n-butyl phthalate | 606 | 625, 1625B | | 6410 B [18th, 19th, 20th]. | 6410 B-00 | | See footnote ⁹ , p. 27 |
| 52. Di-n-octyl phthalate | 606 | 625, 1625B | | 6410 B [18th, 19th, 20th]. | 6410 B-00 | | See footnote ⁹ , p. 27 |
| 53. 2,3-Dinitrophenol | 604 | 625, 1625B | | 6410 B, 6420 B [18th, 19th, 20th]. | 6410 B-00, 6420 B-00. | | |
| 54. 2,4-Dinitrotoluene | 609 | 625, 1625B | | 6410 B [18th, 19th, 20th]. | 6410 B-00 | | See footnote ⁹ , p. 27 |
| 55. 2,6-Dinitrotoluene | 609 | 625, 1625B | | 6410 B [18th, 19th, 20th]. | 6410 B-00 | | See footnote ⁹ , p. 27 |
| 56. Epichlorohydrin | | | | | | | See footnote ⁹ , p. 130; See footnote ⁶ , p. S102 |
| 57. Ethylbenzene | 602 | 624, 1624B | | 6200 B [20th] and 6210 B [18th, 19th], 6200 C [20th] and 6220 B [18th, 19th]. | 6200 B and C-97 | | |
| 58. Fluoranthene | 610 | 625, 1625B | 610 | 6410 B, 6440 B [18th, 19th, 20th]. | 6410 B-00 | D4657-92 (99) | See footnote ⁹ , p. 27 |

| | | | | | | | |
|--|-------|-----------------------------|-------|---------------------------------------|-----------------|---------------------|--------------------------------------|
| 59. Fluorene | 610 | 625, 1625B | 610 | 6410 B, 6440 B [18th, 19th, 20th]. | 6410 B-00 | D4657-92 (99) | See footnote ⁹ , p. 27 |
| 60. 1,2,3,4,6,7,8- Heptachloro- dibenzofuran. | | 1613B ¹⁰ . | | | | | |
| 61. 1,2,3,4,7,8,9- Heptachloro- dibenzofuran. | | 1613B ¹⁰ . | | | | | |
| 62. 1,2,3,4,6,7,8- Heptachlorodibenzo-p- dioxin. | | 1613B ¹⁰ . | | | | | |
| 63. Hexachlorobenzene .. | 612 | 625, 1625B | | 6410 B [18th, 19th, 20th]. | 6410 B-00 | | See footnote ⁹ , p. 27 |
| 64. Hexachloro-butadiene | 612 | 625, 1625B | | 6410 B [18th, 19th, 20th]. | 6410 B-00 | | See footnote ⁹ , p. 27 |
| 65. Hexachlorocyclo- pentadiene. | 612 | 625 ⁵ , 1625B .. | | 6410 B [18th, 19th, 20th]. | 6410 B-00 | | See footnote ⁹ , p. 27 |
| 66. 1,2,3,4,7,8- Hexachlorodibenzofura- n. | | 1613B ¹⁰ . | | | | | |
| 67. 1,2,3,6,7,8- Hexachlorodibenzofura- n. | | 1613B ¹⁰ . | | | | | |
| 68. 1,2,3,7,8,9- Hexachlorodibenzofura- n. | | 1613B ¹⁰ . | | | | | |
| 69. 2,3,4,6,7,8- Hexachlorodibenzofura- n. | | 1613B ¹⁰ . | | | | | |
| 70. 1,2,3,4,7,8- Hexachlorodibenzo-p- dioxin. | | 1613B ¹⁰ . | | | | | |
| 71. 1,2,3,6,7,8- Hexachlorodibenzo-p- dioxin. | | 1613B ¹⁰ . | | | | | |
| 72. 1,2,3,7,8,9- Hexachlorodibenzo-p- dioxin 1613B ¹⁰ . | | 1613B ¹⁰ . | | | | | |
| 73. Hexachloroethane | 612 | 625, 1625B | | 6410 B [18th, 19th, 20th]. | 6410 B-00 | | See footnote ⁹ , p. 27 |
| 74. Ideno(1,2,3-cd) py- rene. | 610 | 625, 1625B | 610 | 6410 B, 6440 B [18th, 19th, 20th]. | 6410 B-00 | D4657-92 (99) | See footnote ⁹ , p. 27 |
| 75. Isophorone | 609 | 625, 1625B | | 6410 B [18th, 19th, 20th]. | 6410 B-00 | | See footnote ⁹ , p. 27 |

TABLE IC—LIST OF APPROVED TEST PROCEDURES FOR NON-PESTICIDE ORGANIC COMPOUNDS—Continued

| Parameter ¹ | EPA method number ^{2,7} | | | | Other approved methods | | | |
|--|----------------------------------|------------------------|-------|--|-------------------------|---------------------|--|--|
| | GC | GC/MS | HPLC | Standard Methods [Edition(s)] | Standard Methods Online | ASTM | Other | |
| 76. Methylene chloride | 601 | 624, 1624B | | 6200 C [20th] and 6230 B [18th, 19th]. | 6200 C-97 | | See footnote ³ , p. 130 | |
| 77. 2-Methyl-4,6-dinitrophenol. | 604 | 625, 1625B | | 6410 B, 6420 B [18th, 19th, 20th]. | 6410 B-00, 6420 B-00. | | See footnote ⁹ , p. 27 | |
| 78. Naphthalene | 610 | 625, 1625B | 610 | 6410 B, 6440 B [18th, 19th, 20th]. | 6410 B-00 | | See footnote ⁹ , p. 27 | |
| 79. Nitrobenzene | 609 | 625, 1625B | | 6410 B [18th, 19th, 20th]. | 6410 B-00 | D4657-92 (99) | See footnote ⁹ , p. 27 | |
| 80. 2-Nitrophenol | 604 | 625, 1625B | | 6410 B, 6420 B [18th, 19th, 20th]. | 6410 B-00, 6420 B-00. | | See footnote ⁹ , p. 27 | |
| 81. 4-Nitrophenol | 604 | 625, 1625B | | 6410 B, 6420 B [18th, 19th, 20th]. | 6410 B-00, 6420 B-00. | | See footnote ⁹ , p. 27 | |
| 82. N-Nitrosodimethylamine. | 607 | 6255, 1625B ... | | 6410 B [18th, 19th, 20th]. | 6410 B-00 | | See footnote ⁹ , p. 27 | |
| 83. N-Nitrosodi-n-propylamine. | 607 | 6255, 1625B ... | | 6410 B [18th, 19th, 20th]. | 6410 B-00 | | See footnote ⁹ , p. 27 | |
| 84. N-Nitrosodiphenylamine. | 607 | 6255, 1625B ... | | 6410 B [18th, 19th, 20th]. | 6410 B-00 | | See footnote ⁹ , p. 27 | |
| 85. Octachlorodibenzofuran. | | 1613B ^{10*} . | | | | | | |
| 86. Octachlorodibenzo-p-dioxin. | | 1613B ¹⁰ . | | | | | | |
| 87. 2,2'-Oxybis(2-chloropropane) [also known as bis(2-chloroisopropyl) ether]. | 611 | 625, 1625B | | 6410 B [18th, 19th, 20th]. | 6410 B-00. | | See footnote ³ , p. 43; See footnote ⁸ | |
| 88. PCB-1016 | 608 | 625 | | 6410 B [18th, 19th, 20th]. | 6410 B-00 | | See footnote ³ , p. 43; See footnote ⁸ | |
| 89. PCB-1221 | 608 | 625 | | 6410 B [18th, 19th, 20th]. | 6410 B-00 | | See footnote ³ , p. 43; See footnote ⁸ | |
| 90. PCB-1232 | 608 | 625 | | 6410 B [18th, 19th, 20th]. | 6410 B-00 | | See footnote ³ , p. 43; See footnote ⁸ | |

| | | | | | | |
|--|-------|--|---|-----------------------|---------------------|---|
| 91. PCB-1242 | 608 | 625 | 6410 B [18th, 19th, 20th]. | 6410 B-00 | | See footnote ³ , p. 43; See footnote ⁸ |
| 92. PCB-1248 | 608 | 625. | 6410 B [18th, 19th, 20th]. | 6410 B-00 | | See footnote ³ , p. 43; See footnote ⁸ |
| 93. PCB-1254 | 608 | 625 | 6410 B, 6630 B [18th, 19th, 20th]. | 6410 B-00 | | See footnote ³ , p. 43; See footnote ⁸ |
| 94. PCB-1260 | 608 | 625 | | | | |
| 95. 1,2,3,7,8-Pentachloro-dibenzofuran | | 1613B ¹⁰ . | | | | |
| 96. 2,3,4,7,8-Pentachloro-dibenzofuran | | 1613B ¹⁰ . | | | | |
| 97. 1,2,3,7,8-Pentachlorodibenzo- <i>p</i> -dioxin. | | 1613B ¹⁰ . | | | | |
| 98. Pentachlorophenol | 604 | 625, 1625B | 6410 B, 6630 B [18th, 19th, 20th]. | 6410 B-00 | | See footnote ³ , p. 140; See footnote ⁹ , p. 27 |
| 99. Phenanthrene | 610 | 625, 1625B | 6410 B, 6440 B [18th, 19th, 20th]. | 6410 B-00 | D4657-92 (99) | See footnote ⁹ , p. 27 |
| 100. Phenol | 604 | 625, 1625B | 6410 B, 6420 B [18th, 19th, 20th]. | 6410 B-00, 6420 B-00. | | See footnote ⁹ , p. 27 |
| 101. Pyrene | 610 | 625, 1625B | 6410 B, 6440 B [18th, 19th, 20th]. | 6410 B-00 | D4657-92 (99) | See footnote ⁹ , p. 27 |
| 102. 2,3,7,8-Tetra-chlorodibenzofuran. | | 1613B ¹⁰ . | | | | |
| 103. 2,3,7,8-Tetra-chlorodibenzo- <i>p</i> -dioxin. | | 613, 625 ^{5a} , 1613B ¹⁰ . | | | | |
| 104. 1,1,2,2-Tetra-chloro ethane | 601 | 624, 1624B | 6200 B [20th] and 6210 B [18th, 19th], 6200 C [20th] and 6230 B [18th, 19th]. | 6200 B and C-97 | | See footnote ³ , p. 130 |
| 105. Tetrachloroethene | 601 | 624, 1624B | 6200 B [20th] and 6210 B [18th, 19th], 6200 C [20th] and 6230 B [18th, 19th]. | 6200 B and C-97 | | See footnote ³ , p. 130 |

TABLE IC—LIST OF APPROVED TEST PROCEDURES FOR NON-PESTICIDE ORGANIC COMPOUNDS—Continued

| Parameter ¹ | EPA method number ^{2,7} | | | Other approved methods | | | |
|------------------------------|----------------------------------|------------------|--|---|-------------------------|-------------------------------------|---|
| | GC | GC/MS | HPLC | Standard Methods [Edition(s)] | Standard Methods Online | ASTM | Other |
| 106. Toluene | 602 | 624, 1624B | | 6200 B [20th] and 6210 B [18th, 19th], 6200 C [20th] and 6220 B [18th, 19th]. | 6200 B and C-97. | | |
| 107. 1,2,4-Trichlorobenzene. | 612 | 625, 1625B | | 6410 B [18th, 19th, 20th]. | 6410 B-00 | | See footnote ³ , p. 130; See footnote ⁹ , p. 27 |
| 108. 1,1,1-Trichloroethane. | 601 | 624, 1624B | | 6200 B [20th] and 6210 B [18th, 19th], 6200 C [20th] and 6230 B [18th, 19th]. | 6200 B and C-97. | | |
| 109. 1,1,2-Trichloroethane. | 601 | 624, 1624B | 6200 B [20th] and 6210 B [18th, 19th], 6200 C [20th] and 6230 B [18th, 19th] | 6200 B and C-97 | | See footnote ³ , p. 130. | |
| 110. Trichloroethene | 601 | 624, 1624B | | 6200 B [20th] and 6210 B [18th, 19th], 6200 C [20th] and 6230 B [18th, 19th]. | 6200 B and C-97. | | |
| 111. Trichlorofluoromethane. | 601 | 624 | | 6200 B [20th] and 6210 B [18th, 19th], 6200 C [20th] and 6230 B [18th, 19th]. | 6200 B and C-97. | | |
| 112. 2,4,6-Trichlorophenol. | 604 | 625, 1625B | | 6410 B, 6420 B [18th, 19th, 20th]. | 6410 B-00, 6420 B-00. | | See footnote ⁹ , p. 27 |

| | | | | |
|---------------------------|-----|------------------|--|------------------|
| 113. Vinyl chloride | 601 | 624, 1624B | 6200 B [20th] and 6210 B [18th, 19th], ≤6200 C [20th] and 6230 B [18th, 19th]. | 6200 B and C-97. |
|---------------------------|-----|------------------|--|------------------|

¹All parameters are expressed in micrograms per liter (µg/L) except for Method 1613B in which the parameters are expressed in picograms per liter (pg/L).
²The full text of Methods 601-613, 624, 625, 1624B, and 1625B, are given at Appendix A, "Test Procedures for Analysis of Organic Pollutants," of this Part 136. The full text of Method 1613B is incorporated by reference into this Part 136 and is available from the National Technical Information Services as stock number PB95-104774. The standardized test procedure to be used to determine the method detection limit (MDL) for these test procedures is given at Appendix B, "Definition and Procedure for the Determination of the Method Detection Limit," of this Part 136.
³Methods for Benzidine: Chlorinated Organic Compounds, Pentachlorophenol and Pesticides in Water and Wastewater," U.S. Environmental Protection Agency, September, 1978.
⁴Method 624 may be extended to screen samples for Acrolein and Acrylonitrile. However, when they are known to be present, the preferred method for these two compounds is Method 603 or Method 1624B.
⁵Method 625 may be extended to include benzidine, hexachlorocyclopentadiene, N-nitrosodimethylamine, and N-nitrosodiphenylamine. However, when they are known to be present, Methods 605, 607, and 612, or Method 1625B, are preferred methods for these compounds.
^{5a}625, screening only.
⁶"Selected Analytical Methods Approved and Cited by the United States Environmental Protection Agency," Supplement to the *Fifteenth Edition of Standard Methods for the Examination of Water and Wastewater* (1981).
⁷Each analyst must make an initial, one-time demonstration of their ability to generate acceptable precision and accuracy with Methods 601-603, 624, 625, 1624B, and 1625B (See Appendix A of this Part 136) in accordance with procedures each in Section 8.2 of each of these methods. Additionally, each laboratory, on an on-going basis must spike and analyze 10% (5% for methods 624 and 625 and 100% for methods 1624B and 1625B) of all samples to monitor and evaluate laboratory data quality in accordance with Sections 8.3 and 8.4 of these methods. When the recovery of any parameter falls outside the warning limits, the analytical results for that parameter in the unspiked sample are suspect. The results should be reported, but cannot be used to demonstrate regulatory compliance. These quality control requirements also apply to the Standard Methods, ASTM Methods, ASTM Methods, and other methods cited.
⁸"Organochlorine Pesticides and PCBs in Wastewater Using Empore™ Disk," 3M Corporation Revised 10/28/94.
⁹USGS Method 0-3116-87 from "Methods of Analysis by U.S. Geological Survey National Water Quality Laboratory—Determination of Inorganic and Organic Constituents in Water and Fluvial Sediments," U.S. Geological Survey, Open File Report 93-125.
¹⁰Analysts may use Fluid Management Systems, Inc. PowerPrep system in place of manual cleanup provided that the analysis meet the requirements of Method 1613B (as specified in Section 9 of the method) and permitting authorities.

TABLE ID—LIST OF APPROVED TEST PROCEDURES FOR PESTICIDES 1

| Parameter | Method | EPA ^{2,7} | Standard Methods 18th, 19th, 20th Ed. | Standard Methods Online | ASTM | Other |
|--------------------|-------------|--------------------|---------------------------------------|-------------------------|--------------------|--|
| 1. Aldrin | GC | 608 | 6630 B & C | | D3086-90, | See footnote ³ , p. 7; See footnote ⁴ , p. 27; See footnote ⁸ |
| | GC/MS | 625 | 6410 B | 6410 B-00. | D5812-96 (2002) .. | |
| 2. Ametryn | GC | | | | | See footnote ³ , p. 83; See footnote ⁶ , p. S68 |
| 3. Aminocarb | TLC | | | | | See footnote ³ , p. 94; See footnote ⁶ , p. S16 |
| 4. Atraton | GC | | | | | See footnote ³ , p. 83; See footnote ⁶ , p. S68 |

TABLE ID—LIST OF APPROVED TEST PROCEDURES FOR PESTICIDES¹—Continued

| Parameter | Method | EPA ^{2,7} | Standard Methods 18th, 19th, 20th Ed. | Standard Methods Online | ASTM | Other |
|----------------------|--------------|-------------------------|--|----------------------------|---------------------------|--|
| 5. Atrazine | GC | | | | | See footnote ³ , p. 83; See footnote ⁶ , p. S68; See footnote ⁹ |
| 6. Azinphos methyl | GC | | | | | See footnote ³ , p. 25; See footnote ⁶ , p. S51 |
| 7. Barban | TLC | | | | | See footnote ³ , p. 104; See footnote ⁶ , p. S64 |
| 8. α-BHC | GC | 608 | 6630 B & C | | D3086-90, D5812-96(02) | See footnote ³ , p. 7; See footnote ⁸ |
| 9. β-BHC | GC/MS GC | 625 ⁵ 608 | 6410 B 6630 C | 6410 B-00. | D3086-90, D5812-96(02) | See footnote ⁸ |
| 10. δ-BHC | GC/MS GC | 625 ⁵ 608 | 6410 B 6630 C | 6410 B-00. | D3086-90, D5812-96(02) | See footnote ⁸ |
| 11. γ-BHC (Lindane) | GC/MS GC | 625 ⁵ 608 | 6410 B 6630 B & C | 6410 B-00. | D3086-90, D5812-96(02) | See footnote ³ , p. 7; See footnote ⁴ , p. 27; See footnote ⁸ |
| 12. Captan | GC | | 6630 B | 6410 B-00. | D3086-90, D5812-96(02) | See footnote ³ , p. 7 |
| 13. Carbaryl | TLC | | | | | See footnote ³ , p. 94; See footnote ⁶ , p. S60 |
| 14. Carbo-phenthoion | GC | | | | | See footnote ⁴ , p. 27; See footnote ⁶ , p. S73 |
| 15. Chlordane | GC | 608 | 6630 B & C | | D3086-90, D5812-96(02) | See footnote ³ , p. 7; See footnote ⁴ , p. 27; See footnote ⁸ |
| 16. Chloro-propham | GC/MS TLC | 625 | 6410 B | 6410 B-00. | | See footnote ³ , p. 104; See footnote ⁶ , p. S64. |
| 17. 2,4-D | GC | | 6640 B | | | See footnote ³ , p. 115; See footnote ⁴ , p. 40 |
| 18. 4,4'-DDD | GC | 608 | 6630 B & C | | D3086-90, D5812-96(02) | See footnote ³ , p. 7; See footnote ⁴ , p. 27; See footnote ⁸ |
| 19. 4,4'-DDE | GC/MS GC | 625 608 | 6410 B 6630 B & C | 6410 B-00. | D3086-90, D5812-96(02) | See footnote ³ , p. 7; See footnote ⁴ , p. 27; See footnote ⁸ |
| | GC/MS | 625 | 6410 B | 6410 B-00. | | |

Environmental Protection Agency

§ 136.3

| | | | | | | |
|------------------------|-------------|-------------------------|----------------------|------------|---------------------------|--|
| 20. 4,4'-DDT | GC | 608 | 6630 B & C | | D3086-90, D5812-96(02) | See footnote ³ , p. 7; See footnote ⁴ , p. 27; See footnote ⁸ |
| 21. Demeton-O | GC/MS GC | 625 | 6410 B | 6410 B-00. | | See footnote ³ , p. 25; See footnote ⁶ , p. S51 |
| 22. Demeton-S | GC | | | | | See footnote ³ , p. 25; See footnote ⁶ , p. S51 |
| 23. Diazinon | GC | | | | | See footnote ³ , p. 25; See footnote ⁴ , p. 27; See footnote ⁶ , p. S51 |
| 24. Dicamba | GC | | | | | See footnote ³ , p. 115 |
| 25. Dichlofen-thion | GC | | | | | See footnote ⁴ , p. 27; See footnote ⁶ , p. S73 |
| 26. Dichloran | GC | | 6630 B & C | | D3086-90, D5812-96(02) | See footnote ³ , p. 7; See footnote ⁴ , p. 27; See footnote ⁸ |
| 27. Dicofof | GC | | | | | |
| 28. Dieldrin | GC | 608 | 6630 B & C | | | See footnote ³ , p. 7; See footnote ⁴ , p. 27; See footnote ⁸ |
| 29. Dioxathion | GC/MS GC | 625 | 6410 B | 6410 B-00. | | See footnote ³ , p. 25; See footnote ⁶ , p. S73 |
| 30. Disulfoton | GC | | | | | See footnote ³ , p. 25; See footnote ⁶ , p. S51 |
| 31. Diuron | TLC | | | | | See footnote ³ , p. 104; See footnote ⁶ , p. S64 |
| 32. Endosulfan I | GC | 608 | 6630 B & C | | D3086-90, D5812-96(02) | See footnote ³ , p. 7; See footnote ⁴ , p. 27; See footnote ⁸ |
| 33. Endosulfan II | GC/MS GC | 625 ⁵ 608 | 6410 B 6630 B & C | 6410 B-00. | | See footnote ³ , p. 7; See footnote ⁸ |
| 34. Endosulfan Sulfate | GC/MS GC | 625 ⁵ 608 | 6410 B 6630 C | 6410 B-00. | | See footnote ⁸ |
| 35. Endrin | GC/MS GC | 625 608 | 6410 B 6630 B & C | 6410 B-00. | D3086-90, D5812-96(02) | See footnote ³ , p. 7; See footnote ⁴ , p. 27; See footnote ⁸ |
| 36. Endrin aldehyde | GC/MS GC | 625 ⁵ 608 | 6410 B | 6410 B-00. | | See footnote ⁸ |
| 37. Ethion | GC/MS GC | 625 608 | | | | See footnote ⁴ , p. 27; See footnote ⁶ , p. S73 |
| 38. Fenuron | TLC | | | | | See footnote ³ , p. 104; See footnote ⁶ , p. S64 |
| 39. Fenuron-TCA | TLC | | | | | See footnote ³ , p. 104; See footnote ⁶ , p. S64 |

TABLE ID—LIST OF APPROVED TEST PROCEDURES FOR PESTICIDES¹—Continued

| Parameter | Method | EPA ^{2,7} | Standard Methods 18th, 19th, 20th Ed. | Standard Methods Online | ASTM | Other |
|------------------------------|-------------|--------------------|--|----------------------------|---------------------|--|
| 40. Heptachlor | GC | 608 | 6630 B & C | | D3086-90, | See footnote ³ , p. 7; See footnote ⁴ , p. 27; See footnote ⁸ |
| | GC/MS | 625 | 6410 B | 6410 B-00. | D5812-96(02) | 27; See footnote ⁸ |
| 41. Heptachlor epoxide | GC | 608 | 6630 B & C | | D3086-90, | See footnote ³ , p. 7; See footnote ⁴ , p. 27; See footnote ⁶ , p. S73; See footnote ⁸ |
| | GC/MS | 625 | 6410 B | 6410 B-00. | D5812-96(02) | 27; See footnote ⁶ , p. S73; See footnote ⁸ |
| 42. Isodrin | GC | | | | | See footnote ⁴ , p. 27; See footnote ⁶ , p. S73 |
| 43. Linuron | GC | | | | | See footnote ³ , p. 104; See footnote ⁶ , p. S64 |
| 44. Malathion | GC | | 6630 C | | | See footnote ³ , p. 25; See footnote ⁴ , p. 27; See footnote ⁶ , p. S51 |
| 45. Methiocarb | TLC | | | | | See footnote ³ , p. 94; See footnote ⁶ , p. S60 |
| 46. Methoxy-chlor | GC | | 6630 B & C | | D3086-90, | See footnote ³ , p. 7; See footnote ⁴ , p. 27; See footnote ⁸ |
| | TLC | | | | D5812-96(02), | 27; See footnote ⁸ |
| 47. Mexacar-bate | TLC | | | | | See footnote ³ , p. 94; See footnote ⁶ , p. S60 |
| 48. Mirex | GC | | 6630 B & C | | | See footnote ³ , p. 7; See footnote ⁴ , p. 27 |
| 49. Monuron | TLC | | | | | See footnote ³ , p. 104; See footnote ⁶ , p. S64 |
| 50. Monuron-TCA | TLC | | | | | See footnote ³ , p. 104; See footnote ⁶ , p. S64 |
| 51. Nuburon | TLC | | | | | See footnote ³ , p. 104; See footnote ⁶ , p. S64 |
| 52. Parathion methyl | GC | | 6630 C | | | See footnote ³ , p. 25; See footnote ⁴ , p. 27 |
| 53. Parathion ethyl | GC | | 6630 C | | | See footnote ³ , p. 25; See footnote ⁴ , p. 27 |
| 54. PCNB | GC | | 6630 B & C | | D3086-90, | See footnote ³ , p. 7 |
| 55. Perthane | GC | | | | D5812-96(02), | See footnote ⁴ , p. 27 |
| 56. Prometon | GC | | | | | See footnote ³ , p. 83; See footnote ⁶ , p. S68; See footnote ⁹ |
| 57. Prometryn | GC | | | | | See footnote ³ , p. 83; See footnote ⁶ , p. S68; See footnote ⁹ |
| 58. Propazine | GC | | | | | See footnote ³ , p. 83; See footnote ⁶ , p. S68; See footnote ⁹ |

| | | | | | | |
|-----------------------------|-------------|-----------|------------------|------------|----------------------------|--|
| 59. Propham | TLC | | | | | See footnote ³ , p. 104; See footnote ⁶ , p. S64 |
| 60. Propoxur | TLC | | | | | See footnote ³ , p. 94; See footnote ⁶ , p. S60 |
| 61. Seebumeton | TLC | | | | | See footnote ³ , p. 83; See footnote ⁶ , p. S68 |
| 62. Siduron | TLC | | | | | See footnote ³ , p. 104; See footnote ⁶ , p. S64 |
| 63. Simazine | GC | | | | | See footnote ³ , p. 83; See footnote ⁶ , p. S68; See footnote ⁹ |
| 64. Strobane | GC | | 6630 B & C | | | See footnote ³ , p. 7 |
| 65. Swep | TLC | | | | | See footnote ³ , p. 104; See footnote ⁶ , p. S64 |
| 66. 2,4,5-T | GC | | 6640 B | | | See footnote ³ , p. 115; See footnote ⁴ , p. 40 |
| 67. 2,4,5-TP (Silvex) | GC | | 6640 B | | | See footnote ³ , p. 115; See footnote ⁴ , p. 40 |
| 68. Terbutylazine | GC | | | | | See footnote ³ , p. 83; See footnote ⁶ , p. S68 |
| 69. Toxaphene | GC | 608 | 6630 B & C | | D3086-90, D5812-96(02). | See footnote ³ , p. 7; See footnote ⁴ , p. 27; See footnote ⁸ |
| 70. Trifluralin | GC/MS | 625 | 6410 B | 6410 B-00. | | See footnote ³ , p. 7; See footnote ⁹ |
| | GC | | 6630 B | | | |

¹ Pesticides are listed in this table by common name for the convenience of the reader. Additional pesticides may be found under Table IC, where entries are listed by chemical name.

² The full text of Methods 608 and 625 are given at Appendix A, "Test Procedures for Analysis of Organic Pollutants" of this Part 136. The standardized test procedure to be used to determine the method detection limit (MDL) for these test procedures is given at Appendix B, "Definition and Procedure for the Determination of the Method Detection Limit," of this Part 136.

³ "Methods for Benzidine, Chlorinated Organic Compounds, Pentachlorophenol and Pesticides in Water and Wastewater," U.S. Environmental Protection Agency, September 1978. This EPA publication includes thin-layer chromatography (TLC) methods.

⁴ "Methods for Analysis of Organic Substances in Water and Fluvial Sediments," Techniques of Water-Resources Investigations of the U.S. Geological Survey, Book 5, Chapter A3 (1987).

⁵ The method may be extended to include α -BHC, γ -BHC, endosulfan I, and endrin. However, when they are known to exist, Method 608 is the preferred method.

⁶ "Selected Analytical Methods Approved and Cited by the United States Environmental Protection Agency," Supplement to the Fifteenth Edition of *Standard Methods for the Examination of Water and Wastewater* (1981).

⁷ Each analyst must make an initial, one-time, demonstration of their ability to generate acceptable precision and accuracy with Methods 608 and 625 (See Appendix A of this Part 136) in accordance with procedures given in Section 8.2 of each of these methods. Additionally, each laboratory, on an on-going basis, must spike and analyze 10% of all samples analyzed with Method 608 or 5% of all samples analyzed with Method 625 to monitor and evaluate laboratory data quality in accordance with Sections 8.3 and 8.4 of these methods. When the recovery of any parameter falls outside the warning limits, the analytical results for that parameter in the unspiked sample are suspect. The results should be reported, but cannot be used to demonstrate regulatory compliance. These quality control requirements also apply to the Standard Methods, ASTM Methods, and other methods cited.

⁸ "Organochlorine Pesticides and PCBs in Wastewater Using Empore™ Disk", 3M Corporation, Revised 10/28/94.

⁹ USGS Method 0-3106-93 from "Methods of Analysis by the U.S. Geological Survey National Water Quality Laboratory—Determination of Triazine and Other Nitrogen-containing Compounds by Gas Chromatography with Nitrogen Phosphorus Detectors" U.S. Geological Survey Open File Report 94-37.

TABLE IE—LIST OF APPROVED RADIOLOGIC TEST TEST PROCEDURES

| Parameter and units | Method | Reference (method number or page) | | | | |
|---|--|-----------------------------------|---------------------------------------|--------------------------|--------------|----------------------------|
| | | EPA ¹ | Standard Methods 18th, 19th, 20th Ed. | Standard Methods On-line | ASTM | USGS ² |
| 1. Alpha-Total, pCi per liter ... | Proportional or scintillation counter. | 900.0 | 7110 B | 7110 B-00 | D1943-90, 96 | pp. 75 and 78 ³ |
| 2. Alpha-Counting error, pCi per liter. | Proportional or scintillation counter. | Appendix B | 7110 B | 7110 B-00 | D1943-90, 96 | p. 79 |
| 3. Beta-Total, pCi per liter ... | Proportional counter | 900.0 | 7110 B | 7110 B-00 | D1890-90, 96 | pp. 75 and 78 ³ |
| 4. Beta-Counting error, pCi ... | Proportional counter | Appendix B | 7110 B | 7110 B-00 | D1890-90, 96 | p. 79 |
| 5. (a) Radium Total pCi per liter. | Proportional counter | 903.0 | 7500-Ra B | 7500-Ra B-01 | D2460-90, 97 | |
| (b) Ra, pCi per liter | Scintillation counter | 903.1 | 7500-Ra C | 7500-Ra C-01 | D3454-91, 97 | p. 81 |

¹ Prescribed Procedures for Measurement of Radioactivity in Drinking Water, EPA-600/4-80-032 (1980), U.S. Environmental Protection Agency, August 1980.
² Fishman, M. J. and Brown, Eugene, "Selected Methods of the U.S. Geological Survey of Wastewaters," U.S. Geological Survey, Open-File Report 76-177 (1976).
³ The method found on p. 75 measures only the dissolved portion while the method on p. 78 measures only the suspended portion. Therefore, the two results must be added to obtain the "total."

Environmental Protection Agency

§ 136.3

TABLE IF—LIST OF APPROVED METHODS FOR PHARMACEUTICAL POLLUTANTS

| Pharmaceuticals pollutants | CAS registry No. | Analytical method number |
|-----------------------------|------------------|-------------------------------|
| acetonitrile | 75-05-8 | 1666/1671/D3371/D3695. |
| n-amyl acetate | 628-63-7 | 1666/D3695. |
| n-amyl alcohol | 71-41-0 | 1666/D3695 |
| benzene | 71-43-2 | D4763/D3695/502.2/524.2. |
| n-butyl-acetate | 123-86-4 | 1666/D3695. |
| tert-butyl alcohol | 75-65-0 | 1666. |
| chlorobenzene | 108-90-7 | 502.2/524.2. |
| chloroform | 67-66-3 | 502.2/524.2/551. |
| o-dichlorobenzene | 95-50-1 | 1625C/502.2/524.2. |
| 1,2-dichloroethane | 107-06-2 | D3695/502.2/524.2. |
| diethylamine | 109-89-7 | 1666/1671. |
| dimethyl sulfoxide | 67-68-5 | 1666/1671. |
| ethanol | 64-17-5 | 1666/1671/D3695. |
| ethyl acetate | 141-78-6 | 1666/D3695. |
| n-heptane | 142-82-5 | 1666/D3695. |
| n-hexane | 110-54-3 | 1666/D3695. |
| isobutyraldehyde | 78-84-2 | 1666/1667. |
| isopropanol | 67-63-0 | 1666/D3695. |
| isopropyl acetate | 108-21-4 | 1666/D3695. |
| isopropyl ether | 108-20-3 | 1666/D3695. |
| methanol | 67-56-1 | 1666/1671/D3695. |
| Methyl Cellosolve Δ | 109-86-4 | 1666/1671 |
| methylene chloride | 75-09-2 | 502.2/524.2 |
| methyl formate | 107-31-3 | 1666. |
| 4-methyl-2-pentanone (MIBK) | 108-10-1 | 1624C/1666/D3695/D4763/524.2. |
| phenol | 108-95-2 | D4763. |
| n-propanol | 71-23-8 | 1666/1671/D3695. |
| 2-propanone (acetone) | 67-64-1 | D3695/D4763/524.2. |
| tetrahydrofuran | 109-99-9 | 1666/524.2. |
| toluene | 108-88-3 | D3695/D4763/502.2/524.2. |
| triethylamine | 121-44-8 | 1666/1671. |
| xylene | (Note 1) | 1624C/1666. |

TABLE 1F NOTE:
 1. 1624C: m-xylene 108-38-3, o,p-xylene E-14095 (Not a CAS number; this is the number provided in the Environmental Monitoring Methods Index (EMMI) database.); 1666: m,p-xylene 136777-61-2, o-xylene 95-47-6.

TABLE IG—TEST METHODS FOR PESTICIDE ACTIVE INGREDIENTS

| EPA Survey Code | Pesticide name | CAS No. | EPA Analytical Method No.(s) |
|-----------------|---|------------|------------------------------|
| 8 | Triadimefon | 43121-43-3 | 507/633/525.1/1656 |
| 12 | Dichlorvos | 62-73-7 | 1657/507/622/525.1 |
| 16 | 2,4-D; 2,4-D Salts and Esters [2,4-Dichloro-phenoxyacetic acid]. | 94-75-7 | 1658/515.1/615/515.2/555 |
| 17 | 2,4-DB; 2,4-DB Salts and Esters [2,4-Dichlorophenoxybutyric acid]. | 94-82-6 | 1658/515.1/615/515.2/555 |
| 22 | Mevinphos | 7786-34-7 | 1657/507/622/525.1 |
| 25 | Cyanazine | 21725-46-2 | 629/507 |
| 26 | Propachlor | 1918-16-7 | 1656/508/608.1/525.1 |
| 27 | MCPA; MCPA Salts and Esters [2-Methyl-4-chlorophenoxyacetic acid]. | 94-74-6 | 1658/615/555 |
| 30 | Dichlorprop; Dichlorprop Salts and Esters [2-(2,4-Dichlorophenoxy) propionic acid]. | 120-36-5 | 1658/515.1/615/515.2/555 |
| 31 | MCPA; MCPA Salts and Esters [2-(2-Methyl-4-chlorophenoxy) propionic acid]. | 93-65-2 | 1658/615/555 |
| 35 | TCMTB [2-(Thiocyanomethylthio) benzo-thiazole]. | 21564-17-0 | 637 |
| 39 | Pronamide | 23950-58-5 | 525.1/507/633.1 |
| 41 | Propanil | 709-98-8 | 632.1/1656 |
| 45 | Metribuzin | 21087-64-9 | 507/633/525.1/1656 |
| 52 | Acephate | 30560-19-1 | 1656/1657 |

TABLE IG—TEST METHODS FOR PESTICIDE ACTIVE INGREDIENTS—Continued

| EPA Survey Code | Pesticide name | CAS No. | EPA Analytical Method No.(s) |
|-----------------|--|------------|----------------------------------|
| 53 | Acifluorfen | 50594-66-6 | 515.1/515.2/555 |
| 54 | Alachlor | 15972-60-8 | 505/507/645/525.1/1656 |
| 55 | Aldicarb | 116-06-3 | 531.1 |
| 58 | Ametryn | 834-12-8 | 507/619/525.1 |
| 60 | Atrazine | 1912-24-9 | 505/507/619/525.1/1656 |
| 62 | Benomyl | 17804-35-2 | 631 |
| 68 | Bromacil; Bromacil Salts and Esters. | 314-40-9 | 507/633/525.1/1656 |
| 69 | Bromoxynil | 1689-84-5 | 1625/1661 |
| 69 | Bromoxynil octanoate | 1689-99-2 | 1656 |
| 70 | Butachlor | 23184-66-9 | 507/645/525.1/1656 |
| 73 | Captafol | 2425-06-1 | 1656 |
| 75 | Carbaryl [Sevin] | 63-25-2 | 531.1/632/553 |
| 76 | Carbofuran | 1563-66-2 | 531.1/632 |
| 80 | Chloroneb | 2675-77-6 | 1656/508/608.1/525.1 |
| 82 | Chlorothalonil | 1897-45-6 | 508/608.2/525.1/1656 |
| 84 | Stirofos | 961-11-5 | 1657/507/622/525.1 |
| 86 | Chlorpyrifos | 2921-88-2 | 1657/508/622 |
| 90 | Fenvalerate | 51630-58-1 | 1660 |
| 103 | Diazinon | 333-41-5 | 1657/507/614/622/525.1 |
| 107 | Parathion methyl | 298-00-0 | 1657/614/622 |
| 110 | DCPA [Dimethyl 2,3,5,6-tetrachloro-terephthalate]. | 1861-32-1 | 508/608.2/525.1/515.1/515.2/1656 |
| 112 | Dinoseb | 88-85-7 | 1658/515.1/615/515.2/555 |
| 113 | Dioxathion | 78-34-2 | 1657/614.1 |
| 118 | Nabonate [Disodium cyanodithioimidocarbonate]. | 138-93-2 | 630.1 |
| 119 | Diuron | 330-54-1 | 632/553 |
| 123 | Endothall | 145-73-3 | 548/548.1 |
| 124 | Endrin | 72-20-8 | 1656/505/508/608/617/525.1 |
| 125 | Ethalfuralin | 55283-68-6 | 1656/627 See footnote 1 |
| 126 | Ethion | 563-12-2 | 1657/614/614.1 |
| 127 | Ethoprop | 13194-48-4 | 1657/507/622/525.1 |
| 132 | Fenarimol | 60168-88-9 | 507/633.1/525.1/1656 |
| 133 | Fenthion | 55-38-9 | 1657/622 |
| 138 | Glyphosate [N(Phosphonomethyl) glycine]. | 1071-83-6 | 547 |
| 140 | Heptachlor | 76-44-8 | 1656/505/508/608/617/525.1 |
| 144 | Isopropalin | 33820-53-0 | 1656/627 |
| 148 | Linuron | 330-55-2 | 553/632 |
| 150 | Malathion | 121-75-5 | 1657/614 |
| 154 | Methamidophos | 10265-92-6 | 1657 |
| 156 | Methomyl | 16752-77-5 | 531.1/632 |
| 158 | Methoxychlor | 72-43-5 | 1656/505/508/608.2/617/525.1 |
| 172 | Nabam | 142-59-6 | 630/630.1 |
| 173 | Naled | 300-76-5 | 1657/622 |
| 175 | Norflurazon | 27314-13-2 | 507/645/525.1/1656 |
| 178 | Benfluralin | 1861-40-1 | 11656/1627 |
| 182 | Fensulfothion | 115-90-2 | 1657/622 |
| 183 | Disulfoton | 298-04-4 | 1657/507/614/622/525.1 |
| 185 | Phosmet | 732-11-6 | 1657/622.1 |
| 186 | Azinphos Methyl | 86-50-0 | 1657/614/622 |
| 192 | Organo-tin pesticides | 12379-54-3 | Ind-01/200.7/200.9 |
| 197 | Bolstar | 35400-43-2 | 1657/622 |
| 203 | Parathion | 56-38-2 | 1657/614 |
| 204 | Pendimethalin | 40487-42-1 | 1656 |
| 205 | Pentachloronitrobenzene | 82-68-8 | 1656/608.1/617 |
| 206 | Pentachlorophenol | 87-86-5 | 625/1625/515.2/555/515.1/ 525.1 |
| 208 | Permethrin | 52645-53-1 | 608.2/508/525.1/1656/1660 |
| 212 | Phorate | 298-02-2 | 1657/622 |
| 218 | Busan 85 [Potassium dimethyldithiocarbamate]. | 128-03-0 | 630/630.1 |

Environmental Protection Agency

§ 136.3

TABLE IG—TEST METHODS FOR PESTICIDE ACTIVE INGREDIENTS—Continued

| EPA Survey Code | Pesticide name | CAS No. | EPA Analytical Method No.(s) |
|-----------------|---|------------|------------------------------|
| 219 | Busan 40 [Potassium N-hydroxymethyl-N-methyldithiocarbamate]. | 51026-28-9 | 630/630.1 |
| 220 | KN Methyl [Potassium N-methyldithiocarbamate]. | 137-41-7 | 630/630.1 |
| 223 | Prometon | 1610-18-0 | 507/619/525.1 |
| 224 | Prometryn | 7287-19-6 | 507/619/525.1 |
| 226 | Propazine | 139-40-2 | 507/619/525.1/1656 |
| 230 | Pyrethrin I | 121-21-1 | 1660 |
| 232 | Pyrethrin II | 121-29-9 | 1660 |
| 236 | DEF [S,S,S-Tributyl phosphorotrithioate]. | 78-48-8 | 1657 |
| 239 | Simazine | 122-34-9 | 505/507/619/525.1/1656 |
| 241 | Carbam-S [Sodium dimethyldithiocarbamate]. | 128-04-1 | 630/630.1 |
| 243 | Vapam [Sodium methyldithiocarbamate]. | 137-42-8 | 630/630.1 |
| 252 | Tebuthiuron | 34014-18-1 | 507/525.1 |
| 254 | Terbacil | 5902-51-2 | 507/633/525.1/1656 |
| 255 | Terbufos | 13071-79-9 | 1657/507/614.1/525.1 |
| 256 | Terbutylazine | 5915-41-3 | 619/1656 |
| 257 | Terbutryn | 886-50-0 | 507/619/525.1 |
| 259 | Dazomet | 533-74-4 | 630/630.1/1659 |
| 262 | Toxaphene | 8001-35-2 | 1656/505/508/608/617/525.1 |
| 263 | Merphos [Tributyl phosphorotrithioate]. | 150-50-5 | 1657/507/525.1/622 |
| 264 | Trifluralin | 1582-09-8 | 1656/508/617/627/525.1 |
| 268 | Ziram [Zinc dimethyldithiocarbamate]. | 137-30-4 | 630/630.1 |

¹ Monitor and report as total Trifluralin.

TABLE IH—LIST OF APPROVED MICROBIOLOGICAL METHODS FOR AMBIENT WATER

| Parameter and units | Method ¹ | EPA | Standard methods 18th, 19th, 20th Ed. | Standard methods online | AOAC, ASTM, USGS | Other |
|---|---|--|---------------------------------------|------------------------------------|-----------------------|--|
| Bacteria: 1. <i>E. coli</i> , number per 100 mL | MPN ^{6,8,14} multiple tube, multiple tube/multiple well, | | 9221 B.1/9221 F ^{11,13} | 9221 B.1-99/9221 F ^{1,13} | 991.15 ¹⁰ | Colilert [®] 12,16 Colilert-18 [®] 12,15,16, |
| | MF ^{2,5,6,7,8} two step, or | 1103.1 ¹⁹ | 9223 B ¹² | 9223 B-97 ¹² | D5392-93 ⁹ | mColiBlue-24 [®] 17, |
| | Single step | 1603 ²⁰ , 1604 ²¹ | 9222 B/9222 G ¹⁹ , 9213 D, | 9222 B-97/9222 G ¹⁸ | | Enterolert [®] 12,22, |
| | MPN ^{6,8} multiple tube, | | 9230 B | 9230 B | 9230 B-93 | |
| Protozoa: 3. <i>Cryptosporidium</i> 4. <i>Giardia</i> | Multiple tube/multiple well | 1106.1 ²³ | | | D6503-99 ⁹ | |
| | MF ^{2,5,6,7,8} two step | 1600 ²⁴ | 9230 C | | D5259-92 ⁹ | |
| | Single step, or | p. 143 ³ | | | | |
| | Plate count | 1622 ²⁵ , 1623 ²⁶ , 1623 ²⁶ , | | | | |

¹ The method must be specified when results are reported.
² A 0.45 µm membrane filter (MF) or other pore size certified by the manufacturer to fully retain organisms to be cultivated and to be free of extractables which could interfere with their growth.
³ USEPA, 1978. Microbiological Methods for Monitoring the Environment, Water, and Wastes. Environmental Monitoring and Support Laboratory, U.S. Environmental Protection Agency, Cincinnati, OH. EPA/600/8-78/017.
⁴ [Reserved]
⁵ Because the MF technique usually yields low and variable recovery from chlorinated wastewaters, the Most Probable Number method will be required to resolve any controversies, consistency, and anticipated organism density of the water sample.
⁶ Tests must be conducted to provide organism enumeration (density). Select the appropriate configuration of tubes/filtrations and dilutions/volumes to account for the quality, character, a parallel test should be conducted with a multiple-tube technique to demonstrate applicability and comparability of results.
⁷ When the MF method has not been used previously to test waters with high turbidity, large number of noncoliform bacteria, or samples that may contain organisms stressed by chlorine, to assess the comparability of results obtained with individual methods, it is suggested that side-by-side tests be conducted across seasons of the year with the water samples routinely tested in accordance with the most current Standard Methods for the Examination of Water and Wastewater or EPA alternate test procedure (ATP) guidelines.
⁸ To assess the comparability of results obtained with individual methods, it is suggested that side-by-side tests be conducted across seasons of the year with the water samples routinely tested in accordance with the most current Standard Methods for the Examination of Water and Wastewater or EPA alternate test procedure (ATP) guidelines.
⁹ ASTM, 2000, 1999, 1996. Annual Book of ASTM Standards—Water and Environmental Technology, Section 11.02. ASTM International, 100 Barr Harbor Drive, West Conshohocken, PA 19428.
¹⁰ AOAC, 1985. Official Methods of Analysis of AOAC International, 16th Edition, Volume I, Chapter 17. Association of Official Analytical Chemists International. 481 North Frederick Avenue, Suite 500, Gaithersburg, MD 20877-2417.
¹¹ The multiple-tube fermentation test is used in 9221B.1. Lactose broth may be used in lieu of lauryl tryptose broth (LTB), if at least 25 parallel tests are conducted between this broth and LTB using the water samples normally tested, and this comparison demonstrates that the false-positive rate and false-negative rate for total coliform using lactose broth is less than 10 percent. No requirement exists to run the completed phase on 10 percent of all total coliform-positive tubes on a seasonal basis.
¹² These tests are collectively known as defined enzyme substrate tests, where, for example, a substrate is used to detect the enzyme β-glucuronidase produced by *E. coli*.
¹³ After prior enrichment in a presumptive medium for total coliform using 9221B.1, all presumptive tubes or bottles showing any amount of gas, growth or acidity within 48 h ± 3 h of incubation shall be submitted to 9221F. Commercially available EC-MUG media or EC media supplemented in the laboratory with 50 µg/mL of MUG may be used.
¹⁴ Samples shall be enumerated by the multiple-tube or multiple-tube procedure. Using multiple-tube procedures, employ an appropriate tube and dilution configuration of the sample as needed and report the Most Probable Number (MPN). Samples tested with Colilert[®] may be enumerated with the multiple-well procedures, Quanti-Tray[®] 2000, and the MPN calculated from the table provided by the manufacturer.
¹⁵ Colilert-18[®] is an optimized formulation of the Colilert[®] for the determination of total coliforms and *E. coli* that provides results within 18 h of incubation at 35 °C rather than the 24 h required for the Colilert[®] test and is recommended for marine water samples.
¹⁶ Descriptions of the Colilert[®], Colilert-18[®], Quanti-Tray[®], and Quanti-Tray[®]2000 may be obtained from IDEXX Laboratories, Inc., 1 IDEXX Drive, Westbrook, ME 04092.
¹⁷ A description of the mColiBlue24[®] test, Total Coliforms and *E. coli*, is available from Hach Company, 100 Dayton Ave., Ames, IA 50010.
¹⁸ Subject total coliform positive samples determined by 9222B or other membrane filter procedure to 9222G using NA-MUG media.

¹⁹ USEPA, July 2006, Method 1103.1: *Escherichia coli* (*E. coli*) in Water by Membrane Filtration Using membrane-Thermotolerant *Escherichia coli* Agar (mTEC), U.S. Environmental Protection Agency, Office of Water, Washington, DC EPA-821-R-06-010.

²⁰ USEPA, July 2006, Method 1603: *Escherichia coli* (*E. coli*) in Water by Membrane Filtration Using Modified membrane-Thermotolerant *Escherichia coli* Agar (Modified mTEC), U.S. Environmental Protection Agency, Office of Water, Washington, DC EPA-821-R-06-011.

²¹ Preparation and use of M1 agar with a standard membrane filter procedure is set forth in the article, Brenner et al. 1993, "New Medium for the Simultaneous Detection of Total Coliform and *Escherichia coli* in Water," Appl. Environ. Microbiol. 59:3534-3544 and in USEPA, September 2002: Method 1604, Total Coliforms and *Escherichia coli* (*E. coli*) in Water by Membrane Filtration by Using a Simultaneous Detection Technique (M1 Medium), U.S. Environmental Protection Agency, Office of Water, Washington, DC EPA 821-R-02-024.

²² A description of the Enterolert® test may be obtained from IDEXX Laboratories, Inc., 1 IDEXX Drive, Westbrook, ME 04092.

²³ USEPA, July 2006, Method T106.1: Enterococci in Water by Membrane Filtration Using membrane-Enterococcus-Esculin Iron Agar (mE-EIA), U.S. Environmental Protection Agency, Office of Water, Washington, DC EPA-821-R-06-008.

²⁴ USEPA, July 2006, Method 1600: Enterococci in Water by Membrane Filtration Using membrane-Enterococcus Indoxyl-β-D-Glucoside Agar (mEI), U.S. Environmental Protection Agency, Office of Water, Washington, DC EPA-821-R-06-009.

²⁵ Method 1622 uses filtration, concentration, immunomagnetic separation of oocysts from captured material, immunofluorescence assay to determine concentrations, and confirmation through vital dye staining and differential interference contrast microscopy for the detection of *Cryptosporidium*. USEPA, 2001. Method 1622: *Cryptosporidium* in Water by Filtration/IMS/FA, U.S. Environmental Protection Agency, Office of Water, Washington, DC EPA-821-R-01-026.

²⁶ Method 1623 uses filtration, concentration, immunomagnetic separation of oocysts and cysts from captured material, immunofluorescence assay to determine concentrations, and confirmation through vital dye staining and differential interference contrast microscopy for the simultaneous detection of *Cryptosporidium* and *Giardia* oocysts and cysts. USEPA, 2001. Method 1623. *Cryptosporidium* and *Giardia* in Water by Filtration/IMS/FA, U.S. Environmental Protection Agency, Office of Water, Washington, DC EPA-821-R-01-025.

(b) The full texts of the methods from the following references which are cited in Tables IA, IB, IC, ID, IE, IF, IG and IH are incorporated by reference into this regulation and may be obtained from the source identified. All costs cited are subject to change and must be verified from the indicated source. The full texts of all the test procedures cited are available for inspection at the National Archives and Records Administration (NARA). For information on the availability of this material at NARA, call 202-741-6030, or go to: http://www.archives.gov/federal_register/code_of_federal_regulations/ibr_locations.html.

REFERENCES, SOURCES, COSTS, AND
TABLE CITATIONS:

- (1) The full texts of Methods 601-613, 624, 625, 1613, 1624, and 1625 are printed in appendix A of this part 136. The full text for determining the method detection limit when using the test procedures is given in appendix B of this part 136. The full text of Method 200.7 is printed in appendix C of this part 136. Cited in: Table IB, Note 5; Table IC, Note 2; and Table ID, Note 2.
- (2) USEPA. 1978. Microbiological Methods for Monitoring the Environment, Water, and Wastes. Environmental Monitoring and Support Laboratory, U.S. Environmental Protection Agency, Cincinnati, Ohio. EPA/600/8-78/017. Available at <http://www.epa.gov/clariton/srch.htm> or from: National Technical Information Service, 5285 Port Royal Road, Springfield, Virginia 22161, Pub. No. PB-290329/A.S. Table IA, Note 3; Table IH, Note 3.
- (3) "Methods for Chemical Analysis of Water and Wastes," U.S. Environmental Protection Agency, EPA-600/4-79-020, March 1979, or "Methods for Chemical Analysis of Water and Wastes," U.S. Environmental Protection Agency, EPA-600/4-79-020, Revised March 1983. Available from: ORD Publications, CERL, U.S. Environmental Protection Agency, Cincinnati, Ohio 45268, Table IB, Note 1.
- (4) "Methods for Benzidine, Chlorinated Organic Compounds, Pentachlorophenol and Pesticides in Water and Wastewater," U.S. Environmental Protection Agency, 1978. Available from: ORD Publications, CERL, U.S. Environmental Protection Agency, Cincinnati, Ohio 45268, Table IC, Note 3; Table D, Note 3.
- (5) "Prescribed Procedures for Measurement of Radioactivity in Drinking Water," U.S. Environmental Protection Agency, EPA-600/4-80-032, 1980. Available from: ORD Publications, CERL, U.S. Environmental Protection Agency, Cincinnati, Ohio 45268, Table IE, Note 1.
- (6) American Public Health Association. 1992, 1995, and 1998. Standard Methods for the Examination of Water and Wastewater. 18th, 19th, and 20th Edition (respectively). Available from: American Public Health Association, 1015 15th Street, NW., Washington, DC 20005. Standard Methods Online is available through the Standard Methods Web site (<http://www.standardmethods.org>). Tables IA, IB, IC, ID, IE, and IH.
- (7) Ibid, 15th Edition, 1980. Table IB, Note 30; Table ID.
- (8) Ibid, 14th Edition, 1975. Table IB, Notes 17 and 27.
- (9) "Selected Analytical Methods Approved and Cited by the United States Environmental Protection Agency," Supplement to the 15th Edition of Standard Methods for the Examination of Water and Wastewater, 1981. Available from: American Public Health Association, 1015 Fifteenth Street NW., Washington, DC 20036. Cost available from publisher. Table IB, Note 10; Table IC, Note 6; Table ID, Note 6.
- (10) ASTM International. Annual Book of ASTM Standards, Water, and Environmental Technology, Section 11, Volumes 11.01 and 11.02, 1994, 1996, 1999, Volume 11.02, 2000, and individual standards published after 2000. Available from: ASTM International, 100 Barr Harbor Drive, P.O. Box C700, West Conshohocken, PA 19428-2959, or <http://www.astm.org>. Tables IA, IB, IC, ID, IE, and IH.
- (11) USGS. 1989. U.S. Geological Survey Techniques of Water-Resources Investigations, Book 5, Laboratory Analysis, Chapter A4, Methods for Collection and Analysis of Aquatic Biological and Microbiological Samples, U.S. Geological Survey, U.S. Department of the Interior, Reston, Virginia. Available

from USGS Books and Open-File Reports Section, Federal Center, Box 25425, Denver, Colorado 80225. Table IA, Note 5; Table IH.

(12) "Methods for Determination of Inorganic Substances in Water and Fluvial Sediments," by M.J. Fishman and Linda C. Friedman, Techniques of Water-Resources Investigations of the U.S. Geological Survey, Book 5 Chapter A1 (1989). Available from: U.S. Geological Survey, Denver Federal Center, Box 25425, Denver, CO 80225. Cost: \$108.75 (subject to change). Table IB, Note 2.

(13) "Methods for Determination of Inorganic Substances in Water and Fluvial Sediments," N.W. Skougstad and others, editors. Techniques of Water-Resources Investigations of the U.S. Geological Survey, Book 5, Chapter A1 (1979). Available from: U.S. Geological Survey, Denver Federal Center, Box 25425, Denver, CO 80225. Cost: \$10.00 (subject to change), Table IB, Note 8.

(14) "Methods for the Determination of Organic Substances in Water and Fluvial Sediments," Wershaw, R.L., et al, Techniques of Water-Resources Investigations of the U.S. Geological Survey, Book 5, Chapter A3 (1987). Available from: U.S. Geological Survey, Denver Federal Center, Box 25425, Denver, CO 80225. Cost: \$0.90 (subject to change). Table IB, Note 24; Table ID, Note 4.

(15) "Water Temperature—Influential Factors, Field Measurement and Data Presentation," by H.H. Stevens, Jr., J. Ficke, and G.F. Smoot, Techniques of Water-Resources Investigations of the U.S. Geological Survey, Book 1, Chapter D1, 1975. Available from: U.S. Geological Survey, Denver Federal Center, Box 25425, Denver, CO 80225. Cost: \$1.60 (subject to change). Table IB, Note 32.

(16) "Selected Methods of the U.S. Geological Survey of Analysis of Wastewaters," by M.J. Fishman and Eugene Brown; U.S. Geological Survey Open File Report 76-77 (1976). Available from: U.S. Geological Survey, Branch of Distribution, 1200 South Eads Street, Arlington, VA 22202. Cost: \$13.50 (subject to change). Table IE, Note 2.

(17) AOAC-International. Official Methods of Analysis of AOAC-International, 16th Edition, (1995). Available from: AOAC-International, 481 North Frederick Avenue, Suite 500, Gaithers-

burg, MD 20877. Table IB, See footnote 3.

(18) "American National Standard on Photographic Processing Effluents," April 2, 1975. Available from: American National Standards Institute, 1430 Broadway, New York, New York 10018. Table IB, Note 9.

(19) "An Investigation of Improved Procedures for Measurement of Mill Effluent and Receiving Water Color," NCASI Technical Bulletin No. 253, December 1971. Available from: National Council of the Paper Industry for Air and Stream Improvements, Inc., 260 Madison Avenue, New York, NY 10016. Cost available from publisher. Table IB, Note 18.

(20) Ammonia, Automated Electrode Method, Industrial Method Number 379-75WE, dated February 19, 1976. Technicon Auto Analyzer II. Method and price available from Technicon Industrial Systems, Tarrytown, New York 10591. Table IB, Note 7.

(21) Chemical Oxygen Demand, Method 8000, Hach Handbook of Water Analysis, 1979. Method price available from Hach Chemical Company, P.O. Box 389, Loveland, Colorado 80537. Table IB, Note 14.

(22) OIC Chemical Oxygen Demand Method, 1978. Method and price available from Oceanography International Corporation, 512 West Loop, P.O. Box 2980, College Station, Texas 77840. Table IB, Note 13.

(23) ORION Research Instruction Manual, Residual Chlorine Electrode Model 97-70, 1977. Method and price available from ORION Research Incorporation, 840 Memorial Drive, Cambridge, Massachusetts 02138. Table IB, Note 16.

(24) Bicinchoninate Method for Copper. Method 8506, Hach Handbook of Water Analysis, 1979, Method and price available from Hach Chemical Company, P.O. Box 300, Loveland, Colorado 80537. Table IB, Note 19.

(25) Hydrogen Ion (pH) Automated Electrode Method, Industrial Method Number 378-75WA. October 1976. Bran & Luebbe (Technicon) Auto Analyzer II. Method and price available from Bran & Luebbe Analyzing Technologies, Inc. Elmsford, N.Y. 10523. Table IB, Note 21.

(26) 1,10-Phenanthroline Method using FerroVer Iron Reagent for Water,

Hach Method 8008, 1980. Method and price available from Hach Chemical Company, P.O. Box 389 Loveland, Colorado 80537. Table IB, Note 22.

(27) Periodate Oxidation Method for Manganese, Method 8034, Hach Handbook for Water Analysis, 1979. Method and price available from Hach Chemical Company, P.O. Box 389, Loveland, Colorado 80537. Table IB, Note 23.

(28) Nitrogen, Nitrite—Low Range, Diazotization Method for Water and Wastewater, Hach Method 8507, 1979. Method and price available from Hach Chemical Company, P.O. Box 389, Loveland, Colorado 80537. Table IB, Note 25.

(29) Zincon Method for Zinc, Method 8009. Hach Handbook for Water Analysis, 1979. Method and price available from Hach Chemical Company, P.O. Box 389, Loveland, Colorado 80537. Table IB, Note 33.

(30) "Direct Determination of Elemental Phosphorus by Gas-Liquid Chromatography," by R.F. Addison and R.G. Ackman, Journal of Chromatography, Volume 47, No. 3, pp. 421-426, 1970. Available in most public libraries. Back volumes of the Journal of Chromatography are available from Elsevier/North-Holland, Inc., Journal Information Centre, 52 Vanderbilt Avenue, New York, NY 10164. Cost available from publisher. Table IB, Note 28.

(31) "Direct Current Plasma (DCP) Optical Emission Spectrometric Method for Trace Elemental Analysis of Water and Wastes", Method AES 0029, 1986-Revised 1991, Fison Instruments, Inc., 32 Commerce Center, Cherry Hill Drive, Danvers, MA 01923. Table B, Note 34.

(32) "Closed Vessel Microwave Digestion of Wastewater Samples for Determination of Metals, CEM Corporation, P.O. Box 200, Matthews, North Carolina 28106-0200, April 16, 1992. Available from the CEM Corporation. Table IB, Note 36.

(33) "Organochlorine Pesticides and PCBs in Wastewater Using Empore™ Disk" Test Method 3M 0222, Revised 10/28/94. 3M Corporation, 3M Center Building 220-9E-10, St. Paul, MN 55144-1000. Method available from 3M Corporation. Table IC, Note 8 and Table ID, Note 8.

(34) USEPA. October 2002. Methods for Measuring the Acute Toxicity of

Effluents and Receiving Waters to Freshwater and Marine Organisms. Fifth Edition. U.S. Environmental Protection Agency, Office of Water, Washington, DC EPA 821-R-02-012. Available at <http://www.epa.gov/epahome/index/sources.htm> or from National Technical Information Service, 5285 Port Royal Road, Springfield, Virginia 22161, Pub. No. PB2002-108488. Table IA, Note 25.

(35) "Nitrogen, Total Kjeldahl, Method PAI-DK01 (Block Digestion, Steam Distillation, Titrimetric Detection)", revised 12/22/94. Available from Perstorp Analytical Corporation, 9445 SW Ridder Rd., Suite 310, P.O. Box 648, Wilsonville, OK 97070. Table IB, Note 39.

(36) "Nitrogen, Total Kjeldahl, Method PAI-DK02 (Block Digestion, Steam Distillation, Colorimetric Detection)", revised 12/22/94. Available from Perstorp Analytical Corporation, 9445 SW Ridder Rd., Suite 310, P.O. Box 648, Wilsonville, OK 97070. Table IB, Note 40.

(37) "Nitrogen, Total Kjeldahl, Method PAI-DK03 (Block Digestion, Automated FIA Gas Diffusion)", revised 12/22/94. Available from Perstorp Analytical Corporation, 9445 SW Ridder Rd., Suite 310, P.O. Box 648, Wilsonville, OK 97070. Table IB, Note 41.

(38) USEPA. October 2002. Short-Term Methods for Measuring the Chronic Toxicity of Effluents and Receiving Waters to Freshwater Organisms. Fourth Edition. U.S. Environmental Protection Agency, Office of Water, Washington, DC EPA 821-R-02-013. Available at <http://www.epa.gov/epahome/index/sources.htm> or from National Technical Information Service, 5285 Port Royal Road, Springfield, Virginia 22161, Pub. No. PB2002-108489. Table IA, Note 26.

(39) USEPA. October 2002. Short-Term Methods for Measuring the Chronic Toxicity of Effluents and Receiving Waters to Marine and Estuarine Organisms. Third Edition. U.S. Environmental Protection Agency, Office of Water, Washington, DC EPA 821-R-02-014. Available at <http://www.epa.gov/epahome/index/sources.htm> or from National Technical Information Service, 5285 Port Royal Road, Springfield, Virginia 22161, Pub. No. PB2002-108490. Table IA, Note 27.

(40) EPA Methods 1666, 1667, and 1671 listed in the table above are published in the compendium titled Analytical Methods for the Determination of Pollutants in Pharmaceutical Manufacturing Industry Wastewaters (EPA 821-B-98-016). EPA Methods 502.2 and 524.2 have been incorporated by reference into 40 CFR 141.24 and are in Methods for the Determination of Organic Compounds in Drinking Water, EPA-600/4-88-039, December 1988, Revised, July 1991, and Methods for the Determination of Organic Compounds in Drinking Water—Supplement II, EPA-600/R-92-129, August 1992, respectively. These EPA test method compendia are available from the National Technical Information Service, NTIS PB91-231480 and PB92-207703, U.S. Department of Commerce, 5285 Port Royal Road, Springfield, Virginia 22161. The toll-free number is 800-553-6847. ASTM test methods D3371, D3695, and D4763 are available from the American Society for Testing and Materials, 100 Barr Harbor Drive, West Conshohocken, PA 19428-2959.

(41) USEPA. 2002. Method 1631, Revision E, “Mercury in Water by Oxidation, Purge and Trap, and Cold Vapor Atomic Fluorescence Spectrometry.” September 2002. Office of Water, U.S. Environmental Protection Agency (EPA-821-R-02-019). Available from: National Technical Information Service, 5285 Port Royal Road, Springfield, Virginia 22161. Publication No. PB2002-108220. Cost: \$25.50 (subject to change).

(42) [Reserved]

(43) Method OIA-1677, Available Cyanide by Flow Injection, Ligand Exchange, and Amperometry. August 1999. ALPKEM, OI Analytical, Box 648, Wilsonville, Oregon 97070 (EPA-821-R-99-013). Available from: National Technical Information Service, 5285 Port Royal Road, Springfield, Virginia 22161. Publication No. PB99-132011. Cost: \$22.50. Table IB, Note 44.

(44) “Methods of Analysis by the U.S. Geological Survey National Water Quality Laboratory Determination of Ammonium Plus Organic Nitrogen by a Kjeldahl Digestion Method and an Automated Photometric Finish that Includes Digest Cleanup by Gas Diffusion”, Open File Report (OFR) 00-170. Available from: U.S. Geological Sur-

vey, Denver Federal Center, Box 25425, Denver, CO 80225. Table IB, Note 45.

(45) “Methods of Analysis by the U.S. Geological Survey National Water Quality Laboratory—Determination of Chromium in Water by Graphite Furnace Atomic Absorption Spectrophotometry”, Open File Report (OFR) 93-449. Available from: U.S. Geological Survey, Denver Federal Center, Box 25425, Denver, CO 80225. Table IB, Note 46.

(46) “Methods of Analysis by the U.S. Geological Survey National Water Quality Laboratory—Determination of Molybdenum in Water by Graphite Furnace Atomic Absorption Spectrophotometry”, Open File Report (OFR) 97-198. Available from: U.S. Geological Survey, Denver Federal Center, Box 25425, Denver, CO 80225. Table IB, Note 47.

(47) “Methods of Analysis by the U.S. Geological Survey National Water Quality Laboratory—Determination of Total Phosphorus by Kjeldahl Digestion Method and an Automated Colorimetric Finish That Includes Dialysis” Open File Report (OFR) 92-146. Available from: U.S. Geological Survey, Denver Federal Center, Box 25425, Denver, CO 80225. Table IB, Note 48.

(48) “Methods of Analysis by the U.S. Geological Survey National Water Quality Laboratory—Determination of Arsenic and Selenium in Water and Sediment by Graphite Furnace—Atomic Absorption Spectrometry” Open File Report (OFR) 98-639. Table IB, Note 49.

(49) “Methods of Analysis by the U.S. Geological Survey National Water Quality Laboratory—Determination of Elements in Whole-Water Digests Using Inductively Coupled Plasma-Optical Emission Spectrometry and Inductively Coupled Plasma-Mass Spectrometry”, Open File Report (OFR) 98-165. Available from: U.S. Geological Survey, Denver Federal Center, Box 25425, Denver, CO 80225. Table IB, Note 50.

(50) “Methods of Analysis by the U.S. Geological Survey National Water Quality Laboratory—Determination of Triazine and Other Nitrogen-containing Compounds by Gas Chromatography with Nitrogen Phosphorus Detectors” U.S. Geological Survey Open File Report 94-37. Available from: U.S.

Geological Survey, Denver Federal Center, Box 25425, Denver, CO 80225. Table ID, Note 9.

(51) "Methods of Analysis by the U.S. Geological Survey National Water Quality Laboratory—Determination of Inorganic and Organic Constituents in Water and Fluvial Sediments", Open File Report (OFR) 93-125. Available from: U.S. Geological Survey, Denver Federal Center, Box 25425, Denver, CO 80225. Table IB, Note 51; Table IC, Note 9.

(52) IDEXX Laboratories, Inc. 2002. Description of Colilert®, Colilert-18®, Quanti-Tray®, Quanti-Tray®/2000, Enterolert® methods are available from IDEXX Laboratories, Inc., One Idexx Drive, Westbrook, Maine 04092. Table IA, Notes 17 and 23; Table IH, Notes 16 and 22.

(53) Hach Company, Inc. Revision 2, 1999. Description of m-ColiBlue24® Method, Total Coliforms and *E. coli*, is available from Hach Company, 100 Dayton Ave, Ames IA 50010. Table IA, Note 18; Table IH, Note 17.

(54) USEPA. July 2006. Method 1103.1: *Escherichia coli* (*E. coli*) in Water by Membrane Filtration Using membrane-Thermotolerant *Escherichia coli* Agar (mTEC). U.S. Environmental Protection Agency, Office of Water, Washington DC EPA-621-R-06-010. Available at <http://www.epa.gov/waterscience/methods/>. Table IH, Note 19.

(55) USEPA. July 2006. Method 1106.1: Enterococci in Water by Membrane Filtration Using membrane-Enterococcus-Esculin Iron Agar (mE-EIA). U.S. Environmental Protection Agency, Office of Water, Washington DC EPA-621-R-06-008. Available at <http://www.epa.gov/waterscience/methods/>. Table IH, Note 23

(56) USEPA. July 2006. Method 1603: *Escherichia coli* (*E. coli*) in Water by Membrane Filtration Using Modified membrane-Thermotolerant *Escherichia coli* Agar (Modified mTEC). U.S. Environmental Protection Agency, Office of Water, Washington DC EPA-821-R-06-011. Available at <http://www.epa.gov/waterscience/methods/>. Table IH, Note 19; Table IH, Note 20.

(57) Brenner *et al.* 1993. New Medium for the Simultaneous Detection of Total Coliforms and *Escherichia coli* in Water. Appl. Environ. Microbiol.

59:3534-3544. Available from the American Society for Microbiology, 1752 N Street NW., Washington DC 20036. Table IH, Note 21.

(58) USEPA. September 2002. Method 1604: Total Coliforms and *Escherichia coli* (*E. coli*) in Water by Membrane Filtration Using a Simultaneous Detection Technique (MI Medium). U.S. Environmental Protection Agency, Office of Water, Washington DC EPA-821-R-02-024. Available at <http://www.epa.gov/waterscience/methods/>. Table IH, Note 20.

(59) USEPA. July 2006. Method 1600: Enterococci in Water by Membrane Filtration Using membrane-Enterococcus Indoxyl-β-D-Glucoside Agar (mEI). U.S. Environmental Protection Agency, Office of Water, Washington DC EPA-821-R-06-009. Available at <http://www.epa.gov/waterscience/methods/>. Table IA, Note 24; Table IH, Note 24.

(60) USEPA. April 2001. Method 1622: *Cryptosporidium* in Water by Filtration/IMS/FA. U.S. Environmental Protection Agency, Office of Water, Washington DC EPA-821-R-01-026. Available at <http://www.epa.gov/waterscience/methods/>. Table IH, Note 25.

(61) USEPA. April 2001. Method 1623: *Cryptosporidium* and *Giardia* in Water by Filtration/IMS/FA. U.S. Environmental Protection Agency, Office of Water, Washington DC. EPA-821-R-01-025. Available at <http://www.epa.gov/waterscience/methods/>. Table IH, Note 26.

(62) AOAC. 1995. Official Methods of Analysis of AOAC International, 16th Edition, Volume I, Chapter 17. AOAC International, 481 North Frederick Avenue, Suite 500, Gaithersburg, Maryland 20877-2417. Table IA, Note 11; Table IH.

(63) Waters Corporation. Method D6508, Rev. 2, "Test Method for Determination of Dissolved Inorganic Anions in Aqueous Matrices Using Capillary Ion Electrophoresis and Chromate Electrolyte," available from Waters Corp, 34 Maple Street, Milford, MA 01757, Telephone: 508/482-2131, Fax: 508/482-3625, Table IB, See footnote 54.

(64) Kelada-01, "Kelada Automated Test Methods for Total Cyanide, Acid Dissociable Cyanide, and Thiocyanate," EPA 821-B-01-009 Revision 1.2, August 2001 is available from

Environmental Protection Agency

§ 136.3

National Technical Information Service (NTIS), 5285 Port Royal Road, Springfield, VA 22161 [Order Number PB 2001-108275]. Telephone: 800-553-6847. Table IB, See footnote 55.

(65) QuikChem Method 10-204-00-1-X, "Digestion and Distillation of Total Cyanide in Drinking and Wastewaters using MICRO DIST and Determination of Cyanide by Flow Injection Analysis" Revision 2.2, March 2005 is available from Lachat Instruments 6645 W. Mill Road, Milwaukee, WI 53218, Telephone: 414-358-4200. Table IB, See footnote 56.

(66) "Methods for the Determination of Metals in Environmental Samples," Supplement I, National Exposure Risk Laboratory-Cincinnati (NERL-CI), EPA/600/R-94/111, May 1994; and "Methods for the Determination of Inorganic Substances in Environmental Samples," NERL-CI, EPA/600/R-93/100, August, 1993 are available from National Technical Information Service (NTIS), 5285 Port Royal Road, Springfield, VA 22161. Telephone: 800-553-6847. Table IB.

(67) "Determination of Inorganic Ions in Drinking Water by Ion Chromatography," Rev. 1.0, 1997 is available from <http://www.epa.gov/safewater/methods/met300.pdf>. Table IB.

(68) Table IG Methods are available in "Methods For The Determination of Nonconventional Pesticides In Municipal and Industrial Wastewater, Volume I," EPA 821-R-93-010A, August 1993 Revision I, and "Methods For The Determination of Nonconventional Pesticides In Municipal and Industrial Wastewater, Volume II," EPA 821-R-93-010B (August 1993) are available from National Technical Information Service (NTIS), 5285 Port Royal Road, Springfield, VA 22161. Telephone: 800-553-6847.

(69) Method 245.7, Rev. 2.0, "Mercury in Water by Cold Vapor Atomic Fluorescence Spectrometry," February 2005, EPA-821-R-05-001, available from the U.S. EPA Sample Control Center (operated by CSC), 6101 Stevenson Avenue, Alexandria, VA 22304, Telephone: 703-461-8056. Table IB, See footnote 59.

(70) USEPA. July 2006. Method 1680: Fecal Coliforms in Sewage Sludge (Biosolids) by Multiple-Tube Fermentation using Lauryl Tryptose Broth (LTB) and EC Medium. U.S. Environmental Protection Agency, Office of Water, Wash-

ington DC. EPA 821-R-06-012. Available at <http://www.epa.gov/waterscience/methods/>.

(71) USEPA. July 2006. Method 1681: Fecal Coliforms in Sewage Sludge (Biosolids) by Multiple-Tube Fermentation using A-1 Medium. U.S. Environmental Protection Agency, Office of Water, Washington DC. EPA 821-R-06-013. Available at <http://www.epa.gov/waterscience/methods/>.

(72) USEPA. July 2006. Method 1682: *Salmonella* in Sewage Sludge (Biosolids) by Modified Semisolid Rappaport-Vassiliadis (MSRV) Medium. U.S. Environmental Protection Agency, Office of Water, Washington DC. EPA 821-R-06-014. Available at <http://www.epa.gov/waterscience/methods/>.

(c) Under certain circumstances, the Regional Administrator or the Director in the Region or State where the discharge will occur may determine for a particular discharge that additional parameters or pollutants must be reported. Under such circumstances, additional test procedures for analysis of pollutants may be specified by the Regional Administrator, or the Director upon recommendation of the Alternate Test Procedure Program Coordinator, Washington, DC.

(d) Under certain circumstances, the Administrator may approve additional alternate test procedures for nationwide use, upon recommendation by the Alternate Test Procedure Program Coordinator, Washington, DC.

(e) Sample preservation procedures, container materials, and maximum allowable holding times for parameters are cited in Tables IA, IB, IC, ID, IE, IF, IG and IH are prescribed in Table II. Information in the table takes precedence over information in specific methods or elsewhere. Any person may apply for a variance from the prescribed preservation techniques, container materials, and maximum holding times applicable to samples taken from a specific discharge. Applications for variances may be made by letters to the Regional Administrator in the Region in which the discharge will occur. Sufficient data should be provided to assure such variance does not adversely affect the integrity of the sample. Such data will be forwarded by

the Regional Administrator, to the Alternate Test Procedure Program Coordinator, Washington, DC, for technical review and recommendations for action on the variance application. Upon receipt of the recommendations from the Alternate Test Procedure Program Co-

ordinator, the Regional Administrator may grant a variance applicable to the specific discharge to the applicant. A decision to approve or deny a variance will be made within 90 days of receipt of the application by the Regional Administrator.

TABLE II—REQUIRED CONTAINERS, PRESERVATION TECHNIQUES, AND HOLDING TIMES

| Parameter No./name | Container ¹ | Preservation ^{2,3} | Maximum holding time ⁴ |
|--|---------------------------------------|--|--|
| Table IA—Bacterial Tests: | | | |
| 1–5. Coliform, total, fecal, and <i>E. coli</i> | PA, G | Cool, <10 °C, Na ₂ S ₂ O ₃ ⁵ | 0.0008% 6 hours. ^{22,23} |
| 6. Fecal streptococci | PA, G | Cool, <10 °C, Na ₂ S ₂ O ₃ ⁵ | 0.0008% 6 hours. ²² |
| 7. Enterococci | PA, G | Cool, <10 °C, Na ₂ S ₂ O ₃ ⁵ | 0.0008% 6 hours. ²² |
| 8. Salmonella | PA, G | Cool, <10 °C, Na ₂ S ₂ O ₃ ⁵ | 0.0008% 6 hours. ²² |
| Table IA—Aquatic Toxicity Tests: | | | |
| 9–11. Toxicity, acute and chronic | P, FP, G | Cool, ≤6 °C ¹⁶ | 36 hours. |
| Table IB—Inorganic Tests: | | | |
| 1. Acidity | P, FP, G | Cool, ≤6 °C ¹⁸ | 14 days. |
| 2. Alkalinity | P, FP, G | Cool, ≤6 °C ¹⁸ | 14 days. |
| 4. Ammonia | P, FP, G | Cool, ≤6 °C ¹⁸ , H ₂ SO ₄ to pH<2 | 28 days. |
| 9. Biochemical oxygen demand | P, FP, G | Cool, ≤6 °C ¹⁸ | 48 hours. |
| 10. Boron | P, FP, or Quartz | HNO ₃ to pH<2 | 6 months. |
| 11. Bromide | P, FP, G | None required | 28 days. |
| 14. Biochemical oxygen demand, carbonaceous | P, FP, G | Cool, ≤6 °C ¹⁸ | 48 hours. |
| 15. Chemical oxygen demand | P, FP, G | Cool, ≤6 °C ¹⁸ , H ₂ SO ₄ to pH<2 | 28 days. |
| 16. Chloride | P, FP, G | None required | 28 days. |
| 17. Chlorine, total residual | P, G | None required | Analyze within 15 minutes. |
| 21. Color | P, FP, G | Cool, ≤6 °C ¹⁸ | 48 hours. |
| 23–24. Cyanide, total or available (or CATC) | P, FP, G | Cool, ≤6 °C ¹⁸ , NaOH to pH>12 ⁶ , reducing agent ⁵ | 14 days. |
| 25. Fluoride | P | None required | 28 days. |
| 27. Hardness | P, FP, G | HNO ₃ or H ₂ SO ₄ to pH<2 | 6 months. |
| 28. Hydrogen ion (pH) | P, FP, G | None required | Analyze within 15 minutes. |
| 31, 43. Kjeldahl and organic N | P, FP, G | Cool, ≤6 °C ¹⁸ , H ₂ SO ₄ to pH<2 | 28 days. |
| Table IB—Metals:⁷ | | | |
| 18. Chromium VI | P, FP, G | Cool, ≤6 °C ¹⁸ , pH = 9.3–9.7 ²⁰ | 28 days. |
| 35. Mercury (CVAA) | P, FP, G | HNO ₃ to pH<2 | 28 days. |
| 35. Mercury (CVAFS) | FP, G; and FP-lined cap ¹⁷ | 5 mL/L 12N HCl or 5 mL/L BrCl ¹⁷ | 90 days. ¹⁷ |
| 3, 5–8, 12, 13, 19, 20, 22, 26, 29, 30, 32–34, 36, 37, 45, 47, 51, 52, 58–60, 62, 63, 70–72, 74, 75. Metals, except boron, chromium VI, and mercury. | P, FP, G | HNO ₃ to pH<2, or at least 24 hours prior to analysis ¹⁹ . | 6 months. |
| 38. Nitrate | P, FP, G | Cool, ≤6 °C ¹⁸ | 48 hours. |
| 39. Nitrate-nitrite | P, FP, G | Cool, ≤6 °C ¹⁸ , H ₂ SO ₄ to pH<2 | 28 days. |
| 40. Nitrite | P, FP, G | Cool, ≤6 °C ¹⁸ | 48 hours. |
| 41. Oil and grease | G | Cool to ≤6 °C ¹⁸ , HCl or H ₂ SO ₄ to pH<2. | 28 days. |
| 42. Organic Carbon | P, FP, G | Cool to ≤6 °C ¹⁸ , HCl, H ₂ SO ₄ , or H ₃ PO ₄ to pH<2. | 28 days. |
| 44. Orthophosphate | P, FP, G | Cool, ≤6 °C ¹⁸ | Filter within 15 minutes; Analyze within 48 hours. |
| 46. Oxygen, Dissolved Probe | G, Bottle and top | None required | Analyze within 15 minutes. |
| 47. Winkler | G, Bottle and top | Fix on site and store in dark | 8 hours. |
| 48. Phenols | G | Cool, ≤6 °C ¹⁸ , H ₂ SO ₄ to pH<2 | 28 days. |
| 49. Phosphorous (elemental) | G | Cool, ≤6 °C ¹⁸ | 48 hours. |
| 50. Phosphorous, total | P, FP, G | Cool, ≤6 °C ¹⁸ , H ₂ SO ₄ to pH<2 | 28 days. |
| 53. Residue, total | P, FP, G | Cool, ≤6 °C ¹⁸ | 7 days. |
| 54. Residue, Filterable | P, FP, G | Cool, ≤6 °C ¹⁸ | 7 days. |
| 55. Residue, Nonfilterable (TSS) | P, FP, G | Cool, ≤6 °C ¹⁸ | 7 days. |
| 56. Residue, Settleable | P, FP, G | Cool, ≤6 °C ¹⁸ | 48 hours. |

Environmental Protection Agency

§ 136.3

TABLE II—REQUIRED CONTAINERS, PRESERVATION TECHNIQUES, AND HOLDING TIMES—Continued

| Parameter No./name | Container ¹ | Preservation ^{2,3} | Maximum holding time ⁴ |
|---|---------------------------|--|--|
| 57. Residue, Volatile | P, FP, G | Cool, ≤6 °C ¹⁸ | 7 days. |
| 61. Silica | P or Quartz | Cool, ≤6 °C ¹⁸ | 28 days. |
| 64. Specific conductance | P, FP, G | Cool, ≤6 °C ¹⁸ | 28 days. |
| 65. Sulfate | P, FP, G | Cool, ≤6 °C ¹⁸ | 28 days. |
| 66. Sulfide | P, FP, G | Cool, ≤6 °C ¹⁸ , add zinc acetate plus sodium hydroxide to pH>9. | 7 days. |
| 67. Sulfite | P, FP, G | None required | Analyze within 15 minutes. |
| 68. Surfactants | P, FP, G | Cool, ≤6 °C ¹⁸ | 48 hours. |
| 69. Temperature | P, FP, G | None required | Analyze. |
| 73. Turbidity | P, FP, G | Cool, ≤6 °C ¹⁸ | 48 hours. |
| Table IC—Organic Tests ⁸ | | | |
| 13, 18–20, 22, 24–28, 34–37, 39–43, 45–47, 56, 76, 104, 105, 108–111, 113. Purgeable Halocarbons. | G, FP-lined septum ... | Cool, ≤6 °C ¹⁸ , 0.008% Na ₂ S ₂ O ₃ ⁵ . | 14 days. |
| 6, 57, 106. Purgeable aromatic hydrocarbons. | G, FP-lined septum ... | Cool, ≤6 °C ¹⁸ , 0.008% Na ₂ S ₂ O ₃ ⁵ , HCl to pH 2 ⁹ . | 14 days. ⁹ |
| 3, 4. Acrolein and acrylonitrile | G, FP-lined septum ... | Cool, ≤6 °C ¹⁸ , 0.008% Na ₂ S ₂ O ₃ ⁵ , pH to 4–5 ¹⁰ . | 14 days. ¹⁰ |
| 23, 30, 44, 49, 53, 77, 80, 81, 98, 100, 112. Phenols ¹¹ . | G, FP-lined cap | Cool, ≤6 °C ¹⁸ , 0.008% Na ₂ S ₂ O ₃ ⁵ . | 7 days until extraction, 40 days after extraction. |
| 7, 38. Benzidines ^{11, 12} | G, FP-lined cap | Cool, ≤6 °C ¹⁸ , 0.008% Na ₂ S ₂ O ₃ ⁵ . | 7 days until extraction. ¹³ |
| 14, 17, 48, 50–52. Phthalate esters ¹¹ . | G, FP-lined cap | Cool, ≤6 °C ¹⁸ | 7 days until extraction, 40 days after extraction. |
| 82–84. Nitrosamines ^{11, 14} | G, FP-lined cap | Cool, ≤6 °C ¹⁸ , store in dark, 0.008% Na ₂ S ₂ O ₃ ⁵ . | 7 days until extraction, 40 days after extraction. |
| 88–94. PCBs ¹¹ | G, FP-lined cap | Cool, ≤6 °C ¹⁸ | 1 year until extraction, 1 year after extraction. |
| 54, 55, 75, 79. Nitroaromatics and isophorone ¹¹ . | G, FP-lined cap | Cool, ≤6 °C ¹⁸ , store in dark, 0.008% Na ₂ S ₂ O ₃ ⁵ . | 7 days until extraction, 40 days after extraction. |
| 1, 2, 5, 8–12, 32, 33, 58, 59, 74, 78, 99, 101. Polynuclear aromatic hydrocarbons ¹¹ . | G, FP-lined cap | Cool, ≤6 °C ¹⁸ , store in dark, 0.008% Na ₂ S ₂ O ₃ ⁵ . | 7 days until extraction, 40 days after extraction. |
| 15, 16, 21, 31, 87. Haloethers ¹¹ ... | G, FP-lined cap | Cool, ≤6 °C ¹⁸ , 0.008% Na ₂ S ₂ O ₃ ⁵ . | 7 days until extraction, 40 days after extraction. |
| 29, 35–37, 63–65, 107. Chlorinated hydrocarbons ¹¹ . | G, FP-lined cap | Cool, ≤6 °C ¹⁸ | 7 days until extraction, 40 days after extraction. |
| 60–62, 66–72, 85, 86, 95–97, 102, 103. CDDs/CDFs ¹¹ . | G | Cool, ≤6 °C ¹⁸ , 0.008% Na ₂ S ₂ O ₃ ⁵ , pH<9. | 1 year. |
| Aqueous Samples: Field and Lab Preservation. | G | Cool, ≤6 °C ¹⁸ | 7 days. |
| Solids and Mixed-Phase Samples: Field Preservation. | G | Cool, ≤6 °C ¹⁸ | 24 hours. |
| Tissue Samples: Field Preservation | G | Freeze, ≤ -10 °C | 1 year. |
| Solids, Mixed-Phase, and Tissue Samples: Lab Preservation. | G | | |
| Table ID—Pesticides Tests: | | | |
| 1–70. Pesticides ¹¹ | G, FP-lined cap | Cool, ≤6 °C ¹⁸ , pH 5–9 ¹⁵ | 7 days until extraction, 40 days after extraction. |
| Table IE—Radiological Tests: | | | |
| 1–5. Alpha, beta, and radium | P, FP, G | HNO ₃ to pH<2 | 6 months. |
| Table IH—Bacterial Tests: | | | |
| 1. <i>E. coli</i> | PA, G | Cool, <10 °C, 0.0008% Na ₂ S ₂ O ₃ ⁵ . | 6 hours. ²² |
| 2. Enterococci | PA, G | Cool, <10 °C, 0.0008% Na ₂ S ₂ O ₃ ⁵ . | 6 hours. ²² |
| Table IH—Protozoan Tests: | | | |
| 8. Cryptosporidium | LDPE; field filtration .. | 0–8 °C | 96 hours. ²¹ |

TABLE II—REQUIRED CONTAINERS, PRESERVATION TECHNIQUES, AND HOLDING TIMES—Continued

| Parameter No./name | Container ¹ | Preservation ^{2,3} | Maximum holding time ⁴ |
|--------------------|---------------------------|-----------------------------|-----------------------------------|
| 9. Giardia | LDPE; field filtration .. | 0–8 °C | 96 hours. ²¹ |

¹“P” is polyethylene; “FP” is fluoropolymer (polytetrafluoroethylene (PTFE; Teflon®), or other fluoropolymer, unless stated otherwise in this Table II; “G” is glass; “PA” is any plastic that is made of a sterilizable material (polypropylene or other autoclavable plastic); “LDPE” is low density polyethylene.

²Except where noted in this Table II and the method for the parameter, preserve each grab sample within 15 minutes of collection. For a composite sample collected with an automated sampler (e.g., using a 24-hour composite sampler; see 40 CFR 122.21(g)(7)(i) or 40 CFR Part 403, Appendix E), refrigerate the sample at ≤6 °C during collection unless specified otherwise in this Table II or in the method(s). For a composite sample to be split into separate aliquots for preservation and/or analysis, maintain the sample at ≤6 °C, unless specified otherwise in this Table II or in the method(s), until collection, splitting, and preservation is completed. Add the preservative to the sample container prior to sample collection when the preservative will not compromise the integrity of a grab sample, a composite sample, or an aliquot split from a composite sample; otherwise, preserve the grab sample, composite sample, or aliquot split from a composite sample within 15 minutes of collection. If a composite measurement is required but a composite sample would compromise sample integrity, individual grab samples must be collected at prescribed time intervals (e.g., 4 samples over the course of a day, at 6-hour intervals). Grab samples must be analyzed separately and the concentrations averaged. Alternatively, grab samples may be collected in the field and composited in the laboratory if the compositing procedure produces results equivalent to results produced by arithmetic averaging of the results of analysis of individual grab samples. For examples of laboratory compositing procedures, see EPA Method 1664A (oil and grease) and the procedures at 40 CFR 141.34(f)(14)(iv) and (v) (volatile organics).

³When any sample is to be shipped by common carrier or sent via the U.S. Postal Service, it must comply with the Department of Transportation Hazardous Materials Regulations (49 CFR Part 172). The person offering such material for transportation is responsible for ensuring such compliance. For the preservation requirements of Table II, the Office of Hazardous Materials, Materials Transportation Bureau, Department of Transportation has determined that the Hazardous Materials Regulations do not apply to the following materials: Hydrochloric acid (HCl) in water solutions at concentrations of 0.04% by weight or less (pH about 1.96 or greater); Nitric acid (HNO₃) in water solutions at concentrations of 0.15% by weight or less (pH about 1.62 or greater); Sulfuric acid (H₂SO₄) in water solutions at concentrations of 0.35% by weight or less (pH about 1.15 or greater); and Sodium hydroxide (NaOH) in water solutions at concentrations of 0.080% by weight or less (pH about 12.30 or less).

⁴Samples should be analyzed as soon as possible after collection. The times listed are the maximum times that samples may be held before the start of analysis and still be considered valid (e.g., samples analyzed for fecal coliforms may be held up to 6 hours prior to commencing analysis). Samples may be held for longer periods only if the permittee or monitoring laboratory has data on file to show that, for the specific types of samples under study, the analytes are stable for the longer time, and has received a variance from the Regional Administrator under §136.3(e). For a grab sample, the holding time begins at the time of collection. For a composite sample collected with an automated sampler (e.g., using a 24-hour composite sampler; see 40 CFR 122.21(g)(7)(i) or 40 CFR Part 403, Appendix E), the holding time begins at the time of the end of collection of the composite sample. For a set of grab samples composited in the field or laboratory, the holding time begins at the time of collection of the last grab sample in the set. Some samples may not be stable for the maximum time period given in the table. A permittee or monitoring laboratory is obligated to hold the sample for a shorter time if it knows that a shorter time is necessary to maintain sample stability. See §136.3(e) for details. The date and time of collection of an individual grab sample is the date and time at which the sample is collected. For a set of grab samples to be composited, and that are all collected on the same calendar date, the date of collection is the date on which the samples are collected. For a set of grab samples to be composited, and that are collected across two calendar dates, the date of collection is the dates of the two days; e.g., November 14–15. For a composite sample collected automatically on a given date, the date of collection is the date on which the sample is collected. For a composite sample collected automatically, and that is collected across two calendar dates, the date of collection is the dates of the two days; e.g., November 14–15.

⁵Add a reducing agent only if an oxidant (e.g., chlorine) is present. Reducing agents shown to be effective are sodium thiosulfate (Na₂S₂O₃), ascorbic acid, sodium arsenite (NaAsO₂), or sodium borohydride (NaBH₄). However, some of these agents have been shown to produce a positive or negative cyanide bias, depending on other substances in the sample and the analytical method used. Therefore, do not add an excess of reducing agent. Methods recommending ascorbic acid (e.g., EPA Method 335.4) specify adding ascorbic acid crystals, 0.1–0.6 g, until a drop of sample produces no color on potassium iodide (KI) starch paper, then adding 0.06 g (60 mg) for each liter of sample volume. If NaBH₄ or NaAsO₂ is used, 25 mg/L NaBH₄ or 100 mg/L NaAsO₂ will reduce more than 50 mg/L of chlorine (see method “Kelada-01” and/or Standard Method 4500-CN for more information). After adding reducing agent, test the sample using KI paper, a test strip (e.g. for chlorine, SenSafe™ Total Chlorine Water Check 480010) moistened with acetate buffer solution (see Standard Method 4500-Cl.C.3e), or a chlorine/oxidant test method (e.g., EPA Method 330.4 or 330.5), to make sure all oxidant is removed. If oxidant remains, add more reducing agent. Whatever agent is used, it should be tested to assure that cyanide results are not affected adversely.

⁶Sample collection and preservation: Collect a volume of sample appropriate to the analytical method in a bottle of the material specified. If the sample can be analyzed within 48 hours and sulfide is not present, adjust the pH to > 12 with sodium hydroxide solution (e.g., 5% w/v), refrigerate as specified, and analyze within 48 hours. Otherwise, to extend the holding time to 14 days and mitigate interferences, treat the sample immediately using any or all of the following techniques, as necessary, followed by adjustment of the sample pH to > 12 and refrigeration as specified. There may be interferences that are not mitigated by approved procedures. Any procedure for removal or suppression of an interference may be employed, provided the laboratory demonstrates that it more accurately measures cyanide. Particulate cyanide (e.g., ferric ferrocyanide) or a strong cyanide complex (e.g., cobalt cyanide) are more accurately measured if the laboratory holds the sample at room temperature and pH > 12 for a minimum of 4 hours prior to analysis, and performs UV digestion or dissolution under alkaline (pH=12) conditions, if necessary.

(1) Sulfur: To remove elemental sulfur (S₈), filter the sample immediately. If the filtration time will exceed 15 minutes, use a larger filter or a method that requires a smaller sample volume (e.g., EPA Method 335.4 or Lachat Method 01). Adjust the pH of the filtrate to > 12 with NaOH, refrigerate the filter and filtrate, and ship or transport to the laboratory. In the laboratory, extract the filter with 100 mL of 5% NaOH solution for a minimum of 2 hours. Filter the extract and discard the solids. Combine the 5% NaOH-extracted filtrate with the initial filtrate, lower the pH to approximately 12 with concentrated hydrochloric or sulfuric acid, and analyze the combined filtrate. Because the detection limit for cyanide will be increased by dilution by the filtrate from the solids, test the sample with and without the solids procedure if a low detection limit for cyanide is necessary. Do not use the solids procedure if a higher cyanide concentration is obtained without it. Alternatively, analyze the filtrates from the sample and the solids separately, add the amounts determined (in µg or mg), and divide by the original sample volume to obtain the cyanide concentration.

(2) Sulfide: If the sample contains sulfide as determined by lead acetate paper, or if sulfide is known or suspected to be present, immediately conduct one of the volatilization treatments or the precipitation treatment as follows: Volatilization—Headspace expelling. In a fume hood or well-ventilated area, transfer 0.75 liter of sample to a 4.4 L collapsible container (e.g., Cubitainer™). Acidify with concentrated hydrochloric acid to pH < 2. Cap the container and shake vigorously for 30 seconds. Remove the cap and expel the headspace into the fume hood or open area by collapsing the container without expelling the sample. Refill the headspace by expanding the container. Repeat expelling a total of five headspace volumes. Adjust the pH to > 12, refrigerate, and ship or transport to the laboratory. Scaling to a smaller or larger sample volume must maintain the air to sample volume ratio. A larger volume of air will result in too great a loss of cyanide (> 10%). Dynamic stripping: In a fume hood or well-ventilated area, transfer 0.75 liter of sample to a container of the material specified and acidify with concentrated hydrochloric acid to pH < 2. Using a calibrated air sampling pump or flowmeter, purge the acidified sample into the fume hood or open area through a fritted glass aerator at a flow rate of 2.25 L/min for 4 minutes. Adjust the pH to > 12, refrigerate, and ship or transport to the laboratory. Scaling to a smaller or larger sample volume must maintain the air to sample volume ratio. A larger volume of air will result in too great a loss of cyanide (> 10%). Precipitation: If the sample contains particulate matter that would be removed by filtration, filter the sample prior to treatment to assure that cyanide associated with the particulate matter is included in the measurement. Ship or transport the filter to the laboratory. In the laboratory, extract the filter with 100 mL of 5% NaOH solution for a minimum of 2 hours. Filter the extract and discard the solids. Combine the 5% NaOH-extracted filtrate with the initial filtrate, lower the pH to approximately 12 with concentrated hydrochloric or sulfuric acid, and analyze the combined filtrate. Because the detection limit for cyanide will be increased by dilution by the filtrate from the solids, test the sample with and without the solids procedure if a low detection limit for cyanide is necessary. Do not use the solids procedure if a higher cyanide concentration is obtained without it. Alternatively, analyze the filtrates from the sample and the solids separately, add the amounts determined (in µg or mg), and divide by the original sample volume to obtain the cyanide concentration. For removal of sulfide by precipitation, raise the pH of the sample to > 12 with NaOH solution, then add approximately 1 mg of powdered cadmium chloride for each mL of sample. For example, add approximately 500 mg to a 500-mL sample. Cap and shake the container to mix. Allow the precipitate to settle and test the sample with lead acetate paper. If necessary, add cadmium chloride but avoid adding an excess. Finally, filter through 0.45 micron filter. Cool the sample as specified and ship or transport the filtrate and filter to the laboratory. In the laboratory, extract the filter with 100 mL of 5% NaOH solution for a minimum of 2 hours. Filter the extract and discard the solids. Combine the 5% NaOH-extracted filtrate with the initial filtrate, lower the pH to approximately 12 with concentrated hydrochloric or sulfuric acid, and analyze the combined filtrate. Because the detection limit for cyanide will be increased by dilution by the filtrate from the solids, test the sample with and without the solids procedure if a low detection limit for cyanide is necessary. Do not use the solids procedure if a higher cyanide concentration is obtained without it. Alternatively, analyze the filtrates from the sample and the solids separately, add the amounts determined (in µg or mg), and divide by the original sample volume to obtain the cyanide concentration. If a ligand-exchange method is used (e.g., ASTM D6888), it may be necessary to increase the ligand-exchange reagent to offset any excess of cadmium chloride.

(3) Sulfite, thiosulfate, or thiocyanate: If sulfite, thiosulfate, or thiocyanate is known or suspected to be present, use UV digestion with a glass coil (Method Kelada-01) or ligand exchange (Method OIA-1677) to preclude cyanide loss or positive interference.

(4) Aldehyde: If formaldehyde, acetaldehyde, or another water-soluble aldehyde is known or suspected to be present, treat the sample with 20 mL of 3.5% ethylenediamine solution per liter of sample.

(5) Carbonate: Carbonate interference is evidenced by noticeable effervescence upon acidification in the distillation flask, a reduction in the pH of the absorber solution, and incomplete cyanide spike recovery. When significant carbonate is present, adjust the pH to ≥ 12 using calcium hydroxide instead of sodium hydroxide. Allow the precipitate to settle and decant or filter the sample prior to analysis (also see Standard Method 4500-CN.B.3.d).

(6) Chlorine, hypochlorite, or other oxidant: Treat a sample known or suspected to contain chlorine, hypochlorite, or other oxidant as directed in footnote 5.

⁷For dissolved metals, filter grab samples within 15 minutes of collection and before adding preservatives. For a composite sample collected with an automated sampler (e.g., using a 24-hour composite sampler; see 40 CFR 122.21(g)(7)(i) or 40 CFR Part 403, Appendix E), filter the sample within 15 minutes after completion of collection and before adding preservatives. If it is known or suspected that dissolved sample integrity will be compromised during collection of a composite sample collected automatically over time (e.g., by interchange of a metal between dissolved and suspended forms), collect and filter grab samples to be composited (footnote 2) in place of a composite sample collected automatically.

⁸Guidance applies to samples to be analyzed by GC, LC, or GC/MS for specific compounds.

⁹If the sample is not adjusted to pH 2, then the sample must be analyzed within seven days of sampling.

¹⁰The pH adjustment is not required if acrolein will not be measured. Samples for acrolein receiving no pH adjustment must be analyzed within 3 days of sampling.

¹¹When the extractable analytes of concern fall within a single chemical category, the specified preservative and maximum holding times should be observed for optimum safeguard of sample integrity (i.e., use all necessary preservatives and hold for the shortest time listed). When the analytes of concern fall within two or more chemical categories, the sample may be preserved by cooling to ≤ 6 °C, reducing residual chlorine with 0.008% sodium thiosulfate, storing in the dark, and adjusting the pH to 6–9; samples preserved in this manner may be held for seven days before extraction and for forty days after extraction. Exceptions to this optional preservation and holding time procedure are noted in footnote 5 (regarding the requirement for thiosulfate reduction), and footnotes 12, 13 (regarding the analysis of benzidine).

¹²If 1,2-diphenylhydrazine is likely to be present, adjust the pH of the sample to 4.0 ± 0.2 to prevent rearrangement to benzidine.

¹³Extracts may be stored up to 30 days at < 0 °C.

¹⁴For the analysis of diphenylnitrosamine, add 0.008% Na₂S₂O₃ and adjust pH to 7–10 with NaOH within 24 hours of sampling.

¹⁵The pH adjustment may be performed upon receipt at the laboratory and may be omitted if the samples are extracted within 72 hours of collection. For the analysis of aldrin, add 0.008% Na₂S₂O₃.

¹⁶Sufficient ice should be placed with the samples in the shipping container to ensure that ice is still present when the samples arrive at the laboratory. However, even if ice is present when the samples arrive, it is necessary to immediately measure the temperature of the samples and confirm that the preservation temperature maximum has not been exceeded. In the isolated cases where it can be documented that this holding temperature cannot be met, the permittee can be given the option of on-site testing or can request a variance. The request for a variance should include supportive data which show that the toxicity of the effluent samples is not reduced because of the increased holding temperature.

¹⁷Samples collected for the determination of trace level mercury (<100 ng/L) using EPA Method 1631 must be collected in tightly-capped fluoropolymer or glass bottles and preserved with BrCl or HCl solution within 48 hours of sample collection. The time to preservation may be extended to 28 days if a sample is oxidized in the sample bottle. A sample collected for dissolved trace level mercury should be filtered in the laboratory within 24 hours of the time of collection. However, if circumstances preclude overnight shipment, the sample should be filtered in a designated clean area in the field in accordance with procedures given in Method 1669. If sample integrity will not be maintained by shipment to and filtration in the laboratory, the sample must be filtered in a designated clean area in the field within the time period necessary to maintain sample integrity. A sample that has been collected for determination of total or dissolved trace level mercury must be analyzed within 90 days of sample collection.

¹⁸Aqueous samples must be preserved at ≤ 6 °C, and should not be frozen unless data demonstrating that sample freezing does not adversely impact sample integrity is maintained on file and accepted as valid by the regulatory authority. Also, for purposes of NPDES monitoring, the specification of “≤ °C” is used in place of the “4 °C” and “< 4 °C” sample temperature requirements listed in some methods. It is not necessary to measure the sample temperature to three significant figures (1/100th of 1 degree); rather, three significant figures are specified so that rounding down to 6 °C may not be used to meet the ≤ 6 °C requirement. The preservation temperature does not apply to samples that are analyzed immediately (less than 15 minutes).

¹⁹An aqueous sample may be collected and shipped without acid preservation. However, acid must be added at least 24 hours before analysis to dissolve any metals that adsorb to the container walls. If the sample must be analyzed within 24 hours of collection, add the acid immediately (see footnote 2). Soil and sediment samples do not need to be preserved with acid. The allowances in this footnote supersede the preservation and holding time requirements in the approved metals methods.

²⁰To achieve the 28-day holding time, use the ammonium sulfate buffer solution specified in EPA Method 218.6. The allowance in this footnote supersedes preservation and holding time requirements in the approved hexavalent chromium methods, unless this supersession would compromise the measurement, in which case requirements in the method must be followed.

²¹Holding time is calculated from time of sample collection to elution for samples shipped to the laboratory in bulk and calculated from the time of sample filtration to elution for samples filtered in the field.

²²Samples analysis should begin immediately, preferably within 2 hours of collection. The maximum transport time to the laboratory is 6 hours, and samples should be processed within 2 hours of receipt at the laboratory.

²³For fecal coliform samples for sewage sludge (biosolids) only, the holding time is extended to 24 hours for the following sample types using either EPA Method 1680 (LTB-EC) or 1681 (A-1): Class A composted, Class B aerobically digested, and Class B anaerobically digested.

[38 FR 28758, Oct. 16, 1973]

EDITORIAL NOTE: For FEDERAL REGISTER citations affecting §136.3, see the List of CFR Sections Affected, which appears in the Finding Aids section of the printed volume and on GPO Access.

§136.4 Application for alternate test procedures.

(a) Any person may apply to the Regional Administrator in the Region where the discharge occurs for approval of an alternative test procedure.

(b) When the discharge for which an alternative test procedure is proposed occurs within a State having a permit program approved pursuant to section 402 of the Act, the applicant shall submit his application to the Regional Administrator through the Director of the State agency having responsibility for issuance of NPDES permits within such State.

(c) Unless and until printed application forms are made available, an application for an alternate test procedure may be made by letter in triplicate. Any application for an alternate test procedure under this paragraph (c) shall:

(1) Provide the name and address of the responsible person or firm making the discharge (if not the applicant) and the applicable ID number of the existing or pending permit, issuing agency, and type of permit for which the alternate test procedure is requested, and the discharge serial number.

(2) Identify the pollutant or parameter for which approval of an alternate testing procedure is being requested.

(3) Provide justification for using testing procedures other than those specified in Table I.

(4) Provide a detailed description of the proposed alternate test procedure, together with references to published studies of the applicability of the alter-

nate test procedure to the effluents in question.

(d) An application for approval of an alternate test procedure for nationwide use may be made by letter in triplicate to the Alternate Test Procedure Program Coordinator, Office of Science and Technology (4303), Office of Water, U.S. Environmental Protection Agency, 1200 Pennsylvania Ave., NW., Washington, DC 20460. Any application for an alternate test procedure under this paragraph (d) shall:

(1) Provide the name and address of the responsible person or firm making the application.

(2) Identify the pollutant(s) or parameter(s) for which nationwide approval of an alternate testing procedure is being requested.

(3) Provide a detailed description of the proposed alternate procedure, together with references to published or other studies confirming the general applicability of the alternate test procedure to the pollutant(s) or parameter(s) in waste water discharges from representative and specified industrial or other categories.

(4) Provide comparability data for the performance of the proposed alternate test procedure compared to the performance of the approved test procedures.

[38 FR 28760, Oct. 16, 1973, as amended at 41 FR 52785, Dec. 1, 1976; 62 FR 30763, June 5, 1997; 72 FR 11239, Mar. 12, 2007]

§136.5 Approval of alternate test procedures.

(a) The Regional Administrator of the region in which the discharge will

Environmental Protection Agency

§ 136.6

occur has final responsibility for approval of any alternate test procedure proposed by the responsible person or firm making the discharge.

(b) Within thirty days of receipt of an application, the Director will forward such application proposed by the responsible person or firm making the discharge, together with his recommendations, to the Regional Administrator. Where the Director recommends rejection of the application for scientific and technical reasons which he provides, the Regional Administrator shall deny the application and shall forward this decision to the Director of the State Permit Program and to the Alternate Test Procedure Program Coordinator, Office of Science and Technology (4303), Office of Water, U.S. Environmental Protection Agency, 1200 Pennsylvania Ave., NW., Washington, DC 20460.

(c) Before approving any application for an alternate test procedure proposed by the responsible person or firm making the discharge, the Regional Administrator shall forward a copy of the application to the Alternate Test Procedure Program Coordinator, Office of Science and Technology (4303), Office of Water, U.S. Environmental Protection Agency, 1200 Pennsylvania Ave., NW., Washington, DC 20460.

(d) Within ninety days of receipt by the Regional Administrator of an application for an alternate test procedure, proposed by the responsible person or firm making the discharge, the Regional Administrator shall notify the applicant and the appropriate State agency of approval or rejection, or shall specify the additional information which is required to determine whether to approve the proposed test procedure. Prior to the expiration of such ninety day period, a recommendation providing the scientific and other technical basis for acceptance or rejection will be forwarded to the Regional Administrator by the Alternate Test Procedure Program Coordinator, Washington, DC. A copy of all approval and rejection notifications will be forwarded to the Alternate Test Procedure Program Coordinator, Office of Science and Technology (4303), Office of Water, U.S. Environmental Protection Agency, 1200 Pennsylvania Ave., NW.,

Washington, DC 20460, for the purposes of national coordination.

(e) *Approval for nationwide use.* (1) As expeditiously as is practicable after receipt by the Alternate Test Procedure Program Coordinator, Washington, DC, of an application for an alternate test procedure for nationwide use, the Alternate Test Procedure Program Coordinator, Washington, DC, shall notify the applicant in writing whether the application is complete. If the application is incomplete, the applicant shall be informed of the information necessary to make the application complete.

(2) As expeditiously as is practicable after receipt of a complete package, the Alternate Test Procedure Program Coordinator shall perform any analysis necessary to determine whether the alternate test procedure satisfies the applicable requirements of this part, and the Alternate Test Procedure Program Coordinator shall recommend to the Administrator that he/she approve or reject the application and shall also notify the application of the recommendation.

(3) As expeditiously as practicable, an alternate method determined by the Administrator to satisfy the applicable requirements of this part shall be proposed by EPA for incorporation in subsection 136.3 of 40 CFR part 136. EPA shall make available for review all the factual bases for its proposal, including any performance data submitted by the applicant and any available EPA analysis of those data.

(4) Following a period of public comment, EPA shall, as expeditiously as practicable, publish in the FEDERAL REGISTER a final decision to approve or reject the alternate method.

[38 FR 28760, Oct. 16, 1973, as amended at 41 FR 52785, Dec. 1, 1976; 55 FR 33440, Aug. 15, 1990; 62 FR 30763, June 5, 1997; 72 FR 11239, Mar. 12, 2007]

§ 136.6 Method modifications and analytical requirements.

(a) *Definitions of terms used in this section.*

(1) *Analyst* means the person or laboratory using a test procedure (analytical method) in this Part.

(2) *Chemistry of the method* means the reagents and reactions used in a test

procedure that allow determination of the analyte(s) of interest in an environmental sample.

(3) *Determinative technique* means the way in which an analyte is identified and quantified (e.g., colorimetry, mass spectrometry).

(4) *Equivalent Performance* means that the modified method produces results that meet the QC acceptance criteria of the approved method at this part.

(5) *Method-defined analyte* means an analyte defined solely by the method used to determine the analyte. Such an analyte may be a physical parameter, a parameter that is not a specific chemical, or a parameter that may be comprised of a number of substances. Examples of such analytes include temperature, oil and grease, total suspended solids, total phenolics, turbidity, chemical oxygen demand, and biochemical oxygen demand.

(6) *QC* means "quality control."

(b) *Method modifications.*

(1) *Allowable changes.* Except as set forth in paragraph (b)(3) of this section, an analyst may modify an approved test procedure (analytical method) provided that the chemistry of the method or the determinative technique is not changed, and provided that the requirements of paragraph (b)(2) of this section are met.

(i) Potentially acceptable modifications regardless of current method performance include changes between automated and manual discrete instrumentation; changes in the calibration range (provided that the modified range covers any relevant regulatory limit); changes in equipment such as using similar equipment from a vendor other than that mentioned in the method (e.g., a purge-and-trap device from OIA rather than Tekmar), changes in equipment operating parameters such as changing the monitoring wavelength of a colorimeter or modifying the temperature program for a specific GC column; changes to chromatographic columns (treated in greater detail in paragraph (d) of this section); and increases in purge-and-trap sample volumes (provided specifications in paragraph (e) of this section are met). The changes are only allowed provided that all the require-

ments of paragraph (b)(2) of this section are met.

(ii) If the characteristics of a wastewater matrix prevent efficient recovery of organic pollutants and prevent the method from meeting QC requirements, the analyst may attempt to resolve the issue by using salts as specified in *Guidance on Evaluation, Resolution, and Documentation of Analytical Problems Associated with Compliance Monitoring* (EPA 821-B-93-001, June 1993), provided that such salts do not react with or introduce the target pollutant into the sample (as evidenced by the analysis of method blanks, laboratory control samples, and spiked samples that also contain such salts) and that all requirements of paragraph (b)(2) of this section are met. Chlorinated samples must be dechlorinated prior to the addition of such salts.

(iii) If the characteristics of a wastewater matrix result in poor sample dispersion or reagent deposition on equipment and prevents the analyst from meeting QC requirements, the analysts may attempt to resolve the issue by adding an inert surfactant (*i.e.* a surfactant that will not affect the chemistry of the method), which may include Brij-35 or sodium dodecyl sulfate (SDS), provided that such surfactant does not react with or introduce the target pollutant into the sample (as evidenced by the analysis of method blanks, laboratory control samples, and spiked samples that also contain such surfactant) and that all requirements of paragraph (b)(2) of this section are met. Chlorinated samples must be dechlorinated prior to the addition of such surfactant.

(2) *Requirements.* A modified method must produce equivalent performance to the approved methods for the analyte(s) of interest, and the equivalent performance must be documented.

(i) *Requirements for establishing equivalent performance*

(A) If the approved method contains QC tests and QC acceptance criteria, the modified method must use these QC tests and the modified method must meet the QC acceptance criteria. The Analyst may only rely on QC tests and QC acceptance criteria in a method if it includes wastewater matrix QC tests

and QC acceptance criteria (e.g., as matrix spikes) and both initial (start-up) and ongoing QC tests and QC acceptance criteria.

(B) If the approved method does not contain QC tests and QC acceptance criteria, or if the QC tests and QC acceptance criteria in the method do not meet the requirements of paragraph (b)(2)(i)(A) of this section, the analyst must employ QC tests specified in *Protocol for EPA Approval of Alternate Test Procedures for Organic and Inorganic Analytes in Wastewater and Drinking Water* (EPA-821-B-98-002, March 1999) and meet the QC provisions specified therein. In addition, the Analyst must perform on-going QC tests, including assessment of performance of the modified method on the sample matrix (e.g., analysis of a matrix spike/matrix spike duplicate pair for every twenty samples of a discharge analyzed), and analysis of an ongoing precision and recovery sample and a blank with each batch of 20 or fewer samples.

(C) Calibration must be performed using the modified method and the modified method must be tested with every wastewater matrix to which it will be applied (up to nine distinct matrices; as described in the ATP Protocol, after validation in nine distinct matrices, the method may be applied to all wastewater matrices), in addition to any and all reagent water tests. If the performance in the wastewater matrix or reagent water does not meet the QC acceptance criteria the method modification may not be used.

(D) Analysts must test representative effluents with the modified method, and demonstrate that the results are equivalent or superior to results with the unmodified method.

(ii) *Requirements for documentation.* The modified method must be documented in a method write-up or an addendum that describes the modification(s) to the approved method. The write-up or addendum must include a reference number (e.g., method number), revision number, and revision date so that it may be referenced accurately. In addition, the organization that uses the modified method must document the results of QC tests and keep these records, along with a copy

of the method write-up or addendum, for review by an auditor.

(3) *Restrictions.* An analyst may not modify an approved analytical method for a method-defined analyte. In addition, an analyst may not modify an approved method if the modification would result in measurement of a different form or species of an analyte (e.g., a change to a metals digestion or total cyanide distillation). An analyst may also may not modify any sample preservation and/or holding time requirements of an approved method.

(c) *Analytical requirements for multi-analyte methods (Target Analytes).* For the purpose of NPDES reporting, the discharger or permittee must meet QC requirements only for the analyte(s) being measured and reported under the NPDES permit.

(d) The following modifications to approved methods are authorized in the circumstances described below:

(1) *Capillary column.* Use of a capillary (open tubular) GC column rather than a packed column is allowed with EPA Methods 601-613, 624, 625, and 1624B in Appendix A to this part, provided that all QC tests for the approved method are performed and all QC acceptance criteria are met. When changing from a packed column to a capillary column, retention times will change. Analysts are not required to meet retention time specified in the approved method when this change is made. Instead, analysts must generate new retention time tables with capillary columns to be kept on file along with other startup test and ongoing QC data, for review by auditors.

(2) *Increased sample volume in purge and trap methodology.* Use of increased sample volumes, up to a maximum of 25 mL, is allowed for an approved method, provided that the height of the water column in the purge vessel is at least 5 cm. The analyst should also use one or more surrogate analytes that are chemically similar to the analytes of interest in order to demonstrate that the increased sample volume does not adversely affect the analytical results.

[72 FR 11239, Mar. 12, 2007]

APPENDIX A TO PART 136—METHODS FOR
ORGANIC CHEMICAL ANALYSIS OF
MUNICIPAL AND INDUSTRIAL WASTE-
WATER

METHOD 601—PURGEABLE HALOCARBONS

1. Scope and Application

1.1 This method covers the determination of 29 purgeable halocarbons.

The following parameters may be determined by this method:

| Parameter | STORET No. | CAS No. |
|---------------------------------|------------|------------|
| Bromodichloromethane | 32101 | 75-27-4 |
| Bromoform | 32104 | 75-25-2 |
| Bromomethane | 34413 | 74-83-9 |
| Carbon tetrachloride | 32102 | 56-23-5 |
| Chlorobenzene | 34301 | 108-90-7 |
| Chloroethane | 34311 | 75-00-3 |
| 2-Chloroethylvinyl ether | 34576 | 100-75-8 |
| Chloroform | 32106 | 67-66-3 |
| Chloromethane | 34418 | 74-87-3 |
| Dibromochloromethane | 32105 | 124-48-1 |
| 1,2-Dichlorobenzene | 34536 | 95-50-1 |
| 1,3-Dichlorobenzene | 34566 | 541-73-1 |
| 1,4-Dichlorobenzene | 34571 | 106-46-7 |
| Dichlorodifluoromethane | 34668 | 75-71-8 |
| 1,1-Dichloroethane | 34496 | 75-34-3 |
| 1,2-Dichloroethane | 34531 | 107-06-2 |
| 1,1-Dichloroethane | 34501 | 75-35-4 |
| trans-1,2-Dichloroethane | 34546 | 156-60-5 |
| 1,2-Dichloropropane | 34541 | 78-87-5 |
| cis-1,3-Dichloropropene | 34704 | 10061-01-5 |
| trans-1,3-Dichloropropene | 34699 | 10061-02-6 |
| Methylene chloride | 34423 | 75-09-2 |
| 1,1,2,2-Tetrachloroethane | 34516 | 79-34-5 |
| Tetrachloroethene | 34475 | 127-18-4 |
| 1,1,1-Trichloroethane | 34506 | 71-55-6 |
| 1,1,2-Trichloroethane | 34511 | 79-00-5 |
| Tetrachloroethene | 39180 | 79-01-6 |
| Trichlorofluoromethane | 34488 | 75-69-4 |
| Vinyl chloride | 39715 | 75-01-4 |

1.2 This is a purge and trap gas chromatographic (GC) method applicable to the determination of the compounds listed above in municipal and industrial discharges as provided under 40 CFR 136.1. When this method is used to analyze unfamiliar samples for any or all of the compounds above, compound identifications should be supported by at least one additional qualitative technique. This method describes analytical conditions for a second gas chromatographic column that can be used to confirm measurements made with the primary column. Method 624 provides gas chromatograph/mass spectrometer (GC/MS) conditions appropriate for the qualitative and quantitative confirmation of results for most of the parameters listed above.

1.3 The method detection limit (MDL, defined in Section 12.1)¹ for each parameter is listed in Table 1. The MDL for a specific wastewater may differ from those listed, depending upon the nature of interferences in the sample matrix.

1.4 Any modification of this method, beyond those expressly permitted, shall be considered as a major modification subject to application and approval of alternate test procedures under 40 CFR 136.4 and 136.5.

1.5 This method is restricted to use by or under the supervision of analysts experienced in the operation of a purge and trap system and a gas chromatograph and in the interpretation of gas chromatograms. Each analyst must demonstrate the ability to generate acceptable results with this method using the procedure described in Section 8.2.

2. Summary of Method

2.1 An inert gas is bubbled through a 5-mL water sample contained in a specially-designed purging chamber at ambient temperature. The halocarbons are efficiently transferred from the aqueous phase to the vapor phase. The vapor is swept through a sorbent trap where the halocarbons are trapped. After purging is completed, the trap is heated and backflushed with the inert gas to desorb the halocarbons onto a gas chromatographic column. The gas chromatograph is temperature programmed to separate the halocarbons which are then detected with a halide-specific detector.^{2,3}

2.2 The method provides an optional gas chromatographic column that may be helpful in resolving the compounds of interest from interferences that may occur.

3. Interferences

3.1 Impurities in the purge gas and organic compounds outgassing from the plumbing ahead of the trap account for the majority of contamination problems. The analytical system must be demonstrated to be free from contamination under the conditions of the analysis by running laboratory reagent blanks as described in Section 8.1.3. The use of non-Teflon plastic tubing, non-Teflon thread sealants, or flow controllers with rubber components in the purge and trap system should be avoided.

3.2 Samples can be contaminated by diffusion of volatile organics (particularly fluorocarbons and methylene chloride) through the septum seal into the sample during shipment and storage. A field reagent blank prepared from reagent water and carried through the sampling and handling protocol can serve as a check on such contamination.

3.3 Contamination by carry-over can occur whenever high level and low level samples are sequentially analyzed. To reduce carry-over, the purging device and sample syringe must be rinsed with reagent water between sample analyses. Whenever an unusually concentrated sample is encountered, it should be followed by an analysis of reagent water to check for cross contamination. For samples containing large amounts of water-soluble materials, suspended solids,

high boiling compounds or high organohalide levels, it may be necessary to wash out the purging device with a detergent solution, rinse it with distilled water, and then dry it in a 105°C oven between analyses. The trap and other parts of the system are also subject to contamination; therefore, frequent bakeout and purging of the entire system may be required.

4. Safety

4.1 The toxicity or carcinogenicity of each reagent used in this method has not been precisely defined; however, each chemical compound should be treated as a potential health hazard. From this viewpoint, exposure to these chemicals must be reduced to the lowest possible level by whatever means available. The laboratory is responsible for maintaining a current awareness file of OSHA regulations regarding the safe handling of the chemicals specified in this method. A reference file of material data handling sheets should also be made available to all personnel involved in the chemical analysis. Additional references to laboratory safety are available and have been identified^{4,6} for the information of the analyst.

4.2 The following parameters covered by this method have been tentatively classified as known or suspected, human or mammalian carcinogens: carbon tetrachloride, chloroform, 1,4-dichlorobenzene, and vinyl chloride. Primary standards of these toxic compounds should be prepared in a hood. A NIOSH/MESA approved toxic gas respirator should be worn when the analyst handles high concentrations of these toxic compounds.

5. Apparatus and Materials

5.1 Sampling equipment, for discrete sampling.

5.1.1 Vial—25-mL capacity or larger, equipped with a screw cap with a hole in the center (Pierce #13075 or equivalent). Detergent wash, rinse with tap and distilled water, and dry at 105 °C before use.

5.1.2 Septum—Teflon-faced silicone (Pierce #12722 or equivalent). Detergent wash, rinse with tap and distilled water, and dry at 105 °C for 1 h before use.

5.2 Purge and trap system—The purge and trap system consists of three separate pieces of equipment: a purging device, trap, and desorber. Several complete systems are now commercially available.

5.2.1 The purging device must be designed to accept 5-mL samples with a water column at least 3 cm deep. The gaseous head space between the water column and the trap must have a total volume of less than 15 mL. The purge gas must pass through the water column as finely divided bubbles with a diameter of less than 3 mm at the origin. The purge gas must be introduced no more than

5 mm from the base of the water column. The purging device illustrated in Figure 1 meets these design criteria.

5.2.2 The trap must be at least 25 cm long and have an inside diameter of at least 0.105 in. The trap must be packed to contain the following minimum lengths of adsorbents: 1.0 cm of methyl silicone coated packing (Section 6.3.3), 7.7 cm of 2,6-diphenylene oxide polymer (Section 6.3.2), 7.7 cm of silica gel (Section 6.3.4), 7.7 cm of coconut charcoal (Section 6.3.1). If it is not necessary to analyze for dichlorodifluoromethane, the charcoal can be eliminated, and the polymer section lengthened to 15 cm. The minimum specifications for the trap are illustrated in Figure 2.

5.2.3 The desorber must be capable of rapidly heating the trap to 180 °C. The polymer section of the trap should not be heated higher than 180 °C and the remaining sections should not exceed 200 °C. The desorber illustrated in Figure 2 meets these design criteria.

5.2.4 The purge and trap system may be assembled as a separate unit or be coupled to a gas chromatograph as illustrated in Figures 3 and 4.

5.3 Gas chromatograph—An analytical system complete with a temperature programmable gas chromatograph suitable for on-column injection and all required accessories including syringes, analytical columns, gases, detector, and strip-chart recorder. A data system is recommended for measuring peak areas.

5.3.1 Column 1—8 ft long × 0.1 in. ID stainless steel or glass, packed with 1% SP-1000 on Carbopack B (60/80 mesh) or equivalent. This column was used to develop the method performance statements in Section 12. Guidelines for the use of alternate column packings are provided in Section 10.1.

5.3.2 Column 2—6 ft long × 0.1 in. ID stainless steel or glass, packed with chemically bonded n-octane on Porasil-C (100/120 mesh) or equivalent.

5.3.3 Detector—Electrolytic conductivity or microcoulometric detector. These types of detectors have proven effective in the analysis of wastewaters for the parameters listed in the scope (Section 1.1). The electrolytic conductivity detector was used to develop the method performance statements in Section 12. Guidelines for the use of alternate detectors are provided in Section 10.1.

5.4 Syringes—5-mL glass hypodermic with Luerlok tip (two each), if applicable to the purging device.

5.5 Micro syringes—25-μL, 0.006 in. ID needle.

5.6 Syringe valve—2-way, with Luer ends (three each).

5.7 Syringe—5-mL, gas-tight with shut-off valve.

5.8 Bottle—15-mL, screw-cap, with Teflon cap liner.

5.9 Balance—Analytical, capable of accurately weighing 0.0001 g.

6. Reagents

6.1 Reagent water—Reagent water is defined as a water in which an interferent is not observed at the MDL of the parameters of interest.

6.1.1 Reagent water can be generated by passing tap water through a carbon filter bed containing about 1 lb of activated carbon (Filtrisorb-300, Calgon Corp., or equivalent).

6.1.2 A water purification system (Millipore Super-Q or equivalent) may be used to generate reagent water.

6.1.3 Reagent water may also be prepared by boiling water for 15 min. Subsequently, while maintaining the temperature at 90 °C, bubble a contaminant-free inert gas through the water for 1 h. While still hot, transfer the water to a narrow mouth screw-cap bottle and seal with a Teflon-lined septum and cap.

6.2 Sodium thiosulfate—(ACS) Granular.

6.3 Trap Materials:

6.3.1 Coconut charcoal—6/10 mesh sieved to 26 mesh, Barnabey Cheney, CA-580-26 lot # M-2649 or equivalent.

6.3.2 2,6-Diphenylene oxide polymer—Tenax, (60/80 mesh), chromatographic grade or equivalent.

6.3.3 Methyl silicone packing—3% OV-1 on Chromosorb-W (60/80 mesh) or equivalent.

6.3.4 Silica gel—35/60 mesh, Davison, grade-15 or equivalent.

6.4 Methanol—Pesticide quality or equivalent.

6.5 Stock standard solutions—Stock standard solutions may be prepared from pure standard materials or purchased as certified solutions. Prepare stock standard solutions in methanol using assayed liquids or gases as appropriate. Because of the toxicity of some of the organohalides, primary dilutions of these materials should be prepared in a hood. A NIOSH/MESA approved toxic gas respirator should be used when the analyst handles high concentrations of such materials.

6.5.1 Place about 9.8 mL of methanol into a 10-mL ground glass stoppered volumetric flask. Allow the flask to stand, unstoppered, for about 10 min or until all alcohol wetted surfaces have dried. Weigh the flask to the nearest 0.1 mg.

6.5.2 Add the assayed reference material:

6.5.2.1 Liquid—Using a 100 μ L syringe, immediately add two or more drops of assayed reference material to the flask, then reweigh. Be sure that the drops fall directly into the alcohol without contacting the neck of the flask.

6.5.2.2 Gases—To prepare standards for any of the six halocarbons that boil below 30 °C (bromomethane, chloroethane, chloromethane, dichlorodifluoromethane, trichlorofluoromethane, vinyl chloride), fill

a 5-mL valved gas-tight syringe with the reference standard to the 5.0-mL mark. Lower the needle to 5 mm above the methanol meniscus. Slowly introduce the reference standard above the surface of the liquid (the heavy gas will rapidly dissolve into the methanol).

6.5.3 Reweigh, dilute to volume, stopper, then mix by inverting the flask several times. Calculate the concentration in μ g/ μ L from the net gain in weight. When compound purity is assayed to be 96% or greater, the weight can be used without correction to calculate the concentration of the stock standard. Commercially prepared stock standards can be used at any concentration if they are certified by the manufacturer or by an independent source.

6.5.4 Transfer the stock standard solution into a Teflon-sealed screw-cap bottle. Store, with minimal headspace, at -10 to -20 °C and protect from light.

6.5.5 Prepare fresh standards weekly for the six gases and 2-chloroethylvinyl ether. All other standards must be replaced after one month, or sooner if comparison with check standards indicates a problem.

6.6 Secondary dilution standards—Using stock standard solutions, prepare secondary dilution standards in methanol that contain the compounds of interest, either singly or mixed together. The secondary dilution standards should be prepared at concentrations such that the aqueous calibration standards prepared in Section 7.3.1 or 7.4.1 will bracket the working range of the analytical system. Secondary dilution standards should be stored with minimal headspace and should be checked frequently for signs of degradation or evaporation, especially just prior to preparing calibration standards from them.

6.7 Quality control check sample concentrate—See Section 8.2.1.

7. Calibration

7.1 Assemble a purge and trap system that meets the specifications in Section 5.2. Condition the trap overnight at 180 °C by backflushing with an inert gas flow of at least 20 mL/min. Condition the trap for 10 min once daily prior to use.

7.2 Connect the purge and trap system to a gas chromatograph. The gas chromatograph must be operated using temperature and flow rate conditions equivalent to those given in Table 1. Calibrate the purge and trap-gas chromatographic system using either the external standard technique (Section 7.3) or the internal standard technique (Section 7.4).

7.3 External standard calibration procedure:

7.3.1 Prepare calibration standards at a minimum of three concentration levels for each parameter by carefully adding 20.0 μ L of one or more secondary dilution standards to 100, 500, or 1000 μ L of reagent water. A 25- μ L

syringe with a 0.006 in. ID needle should be used for this operation. One of the external standards should be at a concentration near, but above, the MDL (Table 1) and the other concentrations should correspond to the expected range of concentrations found in real samples or should define the working range of the detector. These aqueous standards can be stored up to 24 h, if held in sealed vials with zero headspace as described in Section 9.2. If not so stored, they must be discarded after 1 h.

7.3.2 Analyze each calibration standard according to Section 10, and tabulate peak height or area responses versus the concentration in the standard. The results can be used to prepare a calibration curve for each compound. Alternatively, if the ratio of response to concentration (calibration factor) is a constant over the working range (<10% relative standard deviation, RSD), linearity through the origin can be assumed and the average ratio or calibration factor can be used in place of a calibration curve.

7.4 Internal standard calibration procedure—To use this approach, the analyst must select one or more internal standards that are similar in analytical behavior to the compounds of interest. The analyst must further demonstrate that the measurement of the internal standard is not affected by method or matrix interferences. Because of these limitations, no internal standard can be suggested that is applicable to all samples. The compounds recommended for use as surrogate spikes in Section 8.7 have been used successfully as internal standards, because of their generally unique retention times.

7.4.1 Prepare calibration standards at a minimum of three concentration levels for each parameter of interest as described in Section 7.3.1.

7.4.2 Prepare a spiking solution containing each of the internal standards using the procedures described in Sections 6.5 and 6.6. It is recommended that the secondary dilution standard be prepared at a concentration of 15 µg/mL of each internal standard compound. The addition of 10 µL of this standard to 5.0 mL of sample or calibration standard would be equivalent to 30 µg/L.

7.4.3 Analyze each calibration standard according to Section 10, adding 10 µL of internal standard spiking solution directly to the syringe (Section 10.4). Tabulate peak height or area responses against concentration for each compound and internal standard, and calculate response factors (RF) for each compound using Equation 1.

$$RF = \frac{(A_s)(C_{is})}{(A_{is})(C_s)}$$

Equation 1

where:

A_s =Response for the parameter to be measured.

A_{is} =Response for the internal standard.

C_{is} =Concentration of the internal standard.

C_s =Concentration of the parameter to be measured.

If the RF value over the working range is a constant (<10% RSD), the RF can be assumed to be invariant and the average RF can be used for calculations. Alternatively, the results can be used to plot a calibration curve of response ratios, A_s/A_{is} , vs. RF.

7.5 The working calibration curve, calibration factor, or RF must be verified on each working day by the measurement of a QC check sample.

7.5.1 Prepare the QC check sample as described in Section 8.2.2.

7.5.2 Analyze the QC check sample according to Section 10.

7.5.3 For each parameter, compare the response (Q) with the corresponding calibration acceptance criteria found in Table 2. If the responses for all parameters of interest fall within the designated ranges, analysis of actual samples can begin. If any individual Q falls outside the range, proceed according to Section 7.5.4.

NOTE: The large number of parameters in Table 2 present a substantial probability that one or more will not meet the calibration acceptance criteria when all parameters are analyzed.

7.5.4 Repeat the test only for those parameters that failed to meet the calibration acceptance criteria. If the response for a parameter does not fall within the range in this second test, a new calibration curve, calibration factor, or RF must be prepared for that parameter according to Section 7.3 or 7.4.

8. Quality Control

8.1 Each laboratory that uses this method is required to operate a formal quality control program. The minimum requirements of this program consist of an initial demonstration of laboratory capability and an ongoing analysis of spiked samples to evaluate and document data quality. The laboratory must maintain records to document the quality of data that is generated. Ongoing data quality checks are compared with established performance criteria to determine if the results of analyses meet the performance characteristics of the method. When results of sample spikes indicate atypical method performance, a quality control check standard must be analyzed to confirm that the measurements were performed in an in-control mode of operation.

8.1.1 The analyst must make an initial, one-time, demonstration of the ability to generate acceptable accuracy and precision

with this method. This ability is established as described in Section 8.2.

8.1.2 In recognition of advances that are occurring in chromatography, the analyst is permitted certain options (detailed in Section 10.1) to improve the separations or lower the cost of measurements. Each time such a modification is made to the method, the analyst is required to repeat the procedure in Section 8.2.

8.1.3 Each day, the analyst must analyze a reagent water blank to demonstrate that interferences from the analytical system are under control.

8.1.4 The laboratory must, on an ongoing basis, spike and analyze a minimum of 10% of all samples to monitor and evaluate laboratory data quality. This procedure is described in Section 8.3.

8.1.5 The laboratory must, on an ongoing basis, demonstrate through the analyses of quality control check standards that the operation of the measurement system is in control. This procedure is described in Section 8.4. The frequency of the check standard analyses is equivalent to 10% of all samples analyzed but may be reduced if spike recoveries from samples (Section 8.3) meet all specified quality control criteria.

8.1.6 The laboratory must maintain performance records to document the quality of data that is generated. This procedure is described in Section 8.5.

8.2 To establish the ability to generate acceptable accuracy and precision, the analyst must perform the following operations.

8.2.1 A quality control (QC) check sample concentrate is required containing each parameter of interest at a concentration of 10 µg/mL in methanol. The QC check sample concentrate must be obtained from the U.S. Environmental Protection Agency, Environmental Monitoring and Support Laboratory in Cincinnati, Ohio, if available. If not available from that source, the QC check sample concentrate must be obtained from another external source. If not available from either source above, the QC check sample concentrate must be prepared by the laboratory using stock standards prepared independently from those used for calibration.

8.2.2 Prepare a QC check sample to contain 20 µg/L of each parameter by adding 200 µL of QC check sample concentrate to 100 mL of reagent water.

8.2.3 Analyze four 5-mL aliquots of the well-mixed QC check sample according to Section 10.

8.2.4 Calculate the average recovery (\bar{X}) in µg/L, and the standard deviation of the recovery (s) in µg/L, for each parameter of interest using the four results.

8.2.5 For each parameter compare s and \bar{X} with the corresponding acceptance criteria for precision and accuracy, respectively, found in Table 2. If s and \bar{X} for all parameters of interest meet the acceptance cri-

teria, the system performance is acceptable and analysis of actual samples can begin. If any individual s exceeds the precision limit or any individual \bar{X} falls outside the range for accuracy, then the system performance is unacceptable for that parameter.

NOTE: The large number of parameters in Table 2 present a substantial probability that one or more will fail at least one of the acceptance criteria when all parameters are analyzed.

8.2.6 When one or more of the parameters tested fail at least one of the acceptance criteria, the analyst must proceed according to Section 8.2.6.1 or 8.2.6.2.

8.2.6.1 Locate and correct the source of the problem and repeat the test for all parameters of interest beginning with Section 8.2.3.

8.2.6.2 Beginning with Section 8.2.3, repeat the test only for those parameters that failed to meet criteria. Repeated failure, however, will confirm a general problem with the measurement system. If this occurs, locate and correct the source of the problem and repeat the test for all compounds of interest beginning with Section 8.2.3.

8.3 The laboratory must, on an ongoing basis, spike at least 10% of the samples from each sample site being monitored to assess accuracy. For laboratories analyzing one to ten samples per month, at least one spiked sample per month is required.

8.3.1 The concentration of the spike in the sample should be determined as follows:

8.3.1.1 If, as in compliance monitoring, the concentration of a specific parameter in the sample is being checked against a regulatory concentration limit, the spike should be at that limit or 1 to 5 times higher than the background concentration determined in Section 8.3.2, whichever concentration would be larger.

8.3.1.2 If the concentration of a specific parameter in the sample is not being checked against a limit specific to that parameter, the spike should be at 20 µg/L or 1 to 5 times higher than the background concentration determined in Section 8.3.2, whichever concentration would be larger.

8.3.2 Analyze one 5-mL sample aliquot to determine the background concentration (B) of each parameter. If necessary, prepare a new QC check sample concentrate (Section 8.2.1) appropriate for the background concentrations in the sample. Spike a second 5-mL sample aliquot with 10 µL of the QC check sample concentrate and analyze it to determine the concentration after spiking (A) of each parameter. Calculate each percent recovery (P) as $100(A - B)/T$, where T is the known true value of the spike.

8.3.3 Compare the percent recovery (P) for each parameter with the corresponding QC acceptance criteria found in Table 2. These acceptance criteria were calculated to include an allowance for error in measurement

of both the background and spike concentrations, assuming a spike to background ratio of 5:1. This error will be accounted for to the extent that the analyst's spike to background ratio approaches 5:1.⁷ If spiking was performed at a concentration lower than 20 µg/L, the analyst must use either the QC acceptance criteria in Table 2, or optional QC acceptance criteria calculated for the specific spike concentration. To calculate optional acceptance criteria for the recovery of a parameter: (1) Calculate accuracy (X') using the equation in Table 3, substituting the spike concentration (T) for C; (2) calculate overall precision (S') using the equation in Table 3, substituting X' for X; (3) calculate the range for recovery at the spike concentration as $(100 X'/T) \pm 2.44(100 S'/T)\%$.⁷

8.3.4 If any individual P falls outside the designated range for recovery, that parameter has failed the acceptance criteria. A check standard containing each parameter that failed the criteria must be analyzed as described in Section 8.4.

8.4 If any parameter fails the acceptance criteria for recovery in Section 8.3, a QC check standard containing each parameter that failed must be prepared and analyzed.

NOTE: The frequency for the required analysis of a QC check standard will depend upon the number of parameters being simultaneously tested, the complexity of the sample matrix, and the performance of the laboratory. If the entire list of parameters in Table 2 must be measured in the sample in Section 8.3, the probability that the analysis of a QC check standard will be required is high. In this case the QC check standard should be routinely analyzed with the spiked sample.

8.4.1 Prepare the QC check standard by adding 10 µL of QC check sample concentrate (Section 8.2.1 or 8.3.2) to 5 mL of reagent water. The QC check standard needs only to contain the parameters that failed criteria in the test in Section 8.3.

8.4.2 Analyze the QC check standard to determine the concentration measured (A) of each parameter. Calculate each percent recovery (P_s) as $100(A/T)\%$, where T is the true value of the standard concentration.

8.4.3 Compare the percent recovery (P_s) for each parameter with the corresponding QC acceptance criteria found in Table 2. Only parameters that failed the test in Section 8.3 need to be compared with these criteria. If the recovery of any such parameter falls outside the designated range, the laboratory performance for that parameter is judged to be out of control, and the problem must be immediately identified and corrected. The analytical result for that parameter in the unspiked sample is suspect and may not be reported for regulatory compliance purposes.

8.5 As part of the QC program for the laboratory, method accuracy for wastewater samples must be assessed and records must be maintained. After the analysis of five

spiked wastewater samples as in Section 8.3, calculate the average percent recovery (\bar{P}) and the standard deviation of the percent recovery (s_p). Express the accuracy assessment as a percent recovery interval from $\bar{P} - 2s_p$ to $\bar{P} + 2s_p$. If $\bar{p}=90\%$ and $s_p=10\%$, for example, the accuracy interval is expressed as 70–110%. Update the accuracy assessment for each parameter on a regular basis (e.g. after each five to ten new accuracy measurements).

8.6 It is recommended that the laboratory adopt additional quality assurance practices for use with this method. The specific practices that are most productive depend upon the needs of the laboratory and the nature of the samples. Field duplicates may be analyzed to assess the precision of the environmental measurements. When doubt exists over the identification of a peak on the chromatogram, confirmatory techniques such as gas chromatography with a dissimilar column, specific element detector, or mass spectrometer must be used. Whenever possible, the laboratory should analyze standard reference materials and participate in relevant performance evaluation studies.

8.7 The analyst should monitor both the performance of the analytical system and the effectiveness of the method in dealing with each sample matrix by spiking each sample, standard, and reagent water blank with surrogate halocarbons. A combination of bromochloromethane, 2-bromo-1-chloropropane, and 1,4-dichlorobutane is recommended to encompass the range of the temperature program used in this method. From stock standard solutions prepared as in Section 6.5, add a volume to give 750 µg of each surrogate to 45 mL of reagent water contained in a 50-mL volumetric flask, mix and dilute to volume for a concentration of 15 ng/µL. Add 10 µL of this surrogate spiking solution directly into the 5-mL syringe with every sample and reference standard analyzed. Prepare a fresh surrogate spiking solution on a weekly basis. If the internal standard calibration procedure is being used, the surrogate compounds may be added directly to the internal standard spiking solution (Section 7.4.2).

9. Sample Collection, Preservation, and Handling

9.1 All samples must be iced or refrigerated from the time of collection until analysis. If the sample contains free or combined chlorine, add sodium thiosulfate preservative (10 mg/40 mL is sufficient for up to 5 ppm Cl₂) to the empty sample bottle just prior to shipping to the sampling site. EPA Methods 330.4 and 330.5 may be used for measurement of residual chlorine.⁸ Field test kits are available for this purpose.

9.2 Grab samples must be collected in glass containers having a total volume of at least 25 mL. Fill the sample bottle just to overflowing in such a manner that no air

bubbles pass through the sample as the bottle is being filled. Seal the bottle so that no air bubbles are entrapped in it. If preservative has been added, shake vigorously for 1 min. Maintain the hermetic seal on the sample bottle until time of analysis.

9.3 All samples must be analyzed within 14 days of collection.³

10. Procedure

10.1 Table 1 summarizes the recommended operating conditions for the gas chromatograph. Included in this table are estimated retention times and MDL that can be achieved under these conditions. An example of the separations achieved by Column 1 is shown in Figure 5. Other packed columns, chromatographic conditions, or detectors may be used if the requirements of Section 8.2 are met.

10.2 Calibrate the system daily as described in Section 7.

10.3 Adjust the purge gas (nitrogen or helium) flow rate to 40 mL/min. Attach the trap inlet to the purging device, and set the purge and trap system to purge (Figure 3). Open the syringe valve located on the purging device sample introduction needle.

10.4 Allow the sample to come to ambient temperature prior to introducing it to the syringe. Remove the plunger from a 5-mL syringe and attach a closed syringe valve. Open the sample bottle (or standard) and carefully pour the sample into the syringe barrel to just short of overflowing. Replace the syringe plunger and compress the sample. Open the syringe valve and vent any residual air while adjusting the sample volume to 5.0 mL. Since this process of taking an aliquot destroys the validity of the sample for future analysis, the analyst should fill a second syringe at this time to protect against possible loss of data. Add 10.0 µL of the surrogate spiking solution (Section 8.7) and 10.0 µL of the internal standard spiking solution (Section 7.4.2), if applicable, through the valve bore, then close the valve.

10.5 Attach the syringe-syringe valve assembly to the syringe valve on the purging device. Open the syringe valves and inject the sample into the purging chamber.

10.6 Close both valves and purge the sample for 11.0 ± 0.1 min at ambient temperature.

10.7 After the 11-min purge time, attach the trap to the chromatograph, adjust the purge and trap system to the desorb mode (Figure 4), and begin to temperature program the gas chromatograph. Introduce the trapped materials to the GC column by rapidly heating the trap to 180 °C while backflushing the trap with an inert gas between 20 and 60 mL/min for 4 min. If rapid heating of the trap cannot be achieved, the GC column must be used as a secondary trap by cooling it to 30 °C (subambient temperature, if poor peak geometry or random reten-

tion time problems persist) instead of the initial program temperature of 45 °C

10.8 While the trap is being desorbed into the gas chromatograph, empty the purging chamber using the sample introduction syringe. Wash the chamber with two 5-mL flushes of reagent water.

10.9 After desorbing the sample for 4 min, recondition the trap by returning the purge and trap system to the purge mode. Wait 15 s then close the syringe valve on the purging device to begin gas flow through the trap. The trap temperature should be maintained at 180 °C. After approximately 7 min, turn off the trap heater and open the syringe valve to stop the gas flow through the trap. When the trap is cool, the next sample can be analyzed.

10.10 Identify the parameters in the sample by comparing the retention times of the peaks in the sample chromatogram with those of the peaks in standard chromatograms. The width of the retention time window used to make identifications should be based upon measurements of actual retention time variations of standards over the course of a day. Three times the standard deviation of a retention time for a compound can be used to calculate a suggested window size; however, the experience of the analyst should weigh heavily in the interpretation of chromatograms.

10.11 If the response for a peak exceeds the working range of the system, prepare a dilution of the sample with reagent water from the aliquot in the second syringe and reanalyze.

11. Calculations

11.1 Determine the concentration of individual compounds in the sample.

11.1.1 If the external standard calibration procedure is used, calculate the concentration of the parameter being measured from the peak response using the calibration curve or calibration factor determined in Section 7.3.2.

11.1.2 If the internal standard calibration procedure is used, calculate the concentration in the sample using the response factor (RF) determined in Section 7.4.3 and Equation 2.

Equation 2

$$\text{Concentration } (\mu\text{g/L}) = \frac{(A_s)(C_{is})}{(A_{is})(\text{RF})}$$

where:

A_s=Response for the parameter to be measured.

A_{is}=Response for the internal standard.

C_{is}=Concentration of the internal standard.

11.2 Report results in µg/L without correction for recovery data. All QC data obtained should be reported with the sample results.

12. Method Performance

12.1 The method detection limit (MDL) is defined as the minimum concentration of a substance that can be measured and reported with 99% confidence that the value is above zero.¹ The MDL concentration listed in Table 1 were obtained using reagent water.¹¹ Similar results were achieved using representative wastewaters. The MDL actually achieved in a given analysis will vary depending on instrument sensitivity and matrix effects.

12.2 This method is recommended for use in the concentration range from the MDL to 1000×MDL. Direct aqueous injection techniques should be used to measure concentration levels above 1000×MDL.

12.3 This method was tested by 20 laboratories using reagent water, drinking water, surface water, and three industrial wastewaters spiked at six concentrations over the range 8.0 to 500 µg/L.⁹ Single operator precision, overall precision, and method accuracy were found to be directly related to the concentration of the parameter and essentially independent of the sample matrix. Linear equations to describe these relationships are presented in Table 3.

References

- 40 CFR part 136, appendix B.
- Bellar, T.A., and Lichtenberg, J.J. "Determining Volatile Organics at Microgram-per-Litre Levels by Gas Chromatography." *Journal of the American Water Works Association*, 66, 739 (1974).
- Bellar, T.A., and Lichtenberg, J.J. "Semi-Automated Headspace Analysis of Drinking Waters and Industrial Waters for Purgeable Volatile Organic Compounds." Proceedings from Symposium on Measurement of Organic Pollutants in Water and Wastewater, American Society for Testing

and Materials, STP 686, C.E. Van Hall, editor, 1978.

4. "Carcinogens—Working With Carcinogens," Department of Health, Education, and Welfare, Public Health Service, Center for Disease Control, National Institute for Occupational Safety and Health, Publication No. 77-206, August 1977.

5. "OSHA Safety and Health Standards, General Industry" (29 CFR part 1910), Occupational Safety and Health Administration, OSHA 2206 (Revised, January 1976).

6. "Safety in Academic Chemistry Laboratories," American Chemical Society Publication, Committee on Chemical Safety, 3rd Edition, 1979.

7. Provost, L.P., and Elder, R.S. "Interpretation of Percent Recovery Data," *American Laboratory*, 15, 58-63 (1983). (The value 2.44 used in the equation in Section 8.3.3 is two times the value 1.22 derived in this report.)

8. "Methods 330.4 (Titrimetric, DPD-FAS) and 330.5 (Spectrophotometric, DPD) for Chlorine, Total Residual," Methods for Chemical Analysis of Water and Wastes, EPA 600/4-79-020, U.S. Environmental Protection Agency, Environmental Monitoring and Support Laboratory, Cincinnati, Ohio 45268, March 1979.

9. "EPA Method Study 24, Method 601—Purgeable Halocarbons by the Purge and Trap Method," EPA 600/4-84-064, National Technical Information Service, PB84-212448, Springfield, Virginia 22161, July 1984.

10. "Method Validation Data for EPA Method 601," Memorandum from B. Potter, U.S. Environmental Protection Agency, Environmental Monitoring and Support Laboratory, Cincinnati, Ohio 45268, November 10, 1983.

11. Bellar, T. A., Unpublished data, U.S. Environmental Protection Agency, Environmental Monitoring and Support Laboratory, Cincinnati, Ohio 45268, 1981.

TABLE 1—CHROMATOGRAPHIC CONDITIONS AND METHOD DETECTION LIMITS

| Parameter | Retention time (min) | | Method detection limit (µg/L) |
|--------------------------------|----------------------|----------|-------------------------------|
| | Column 1 | Column 2 | |
| Chloromethane | 1.50 | 5.28 | 0.08 |
| Bromomethane | 2.17 | 7.05 | 1.18 |
| Dichlorodifluoromethane | 2.62 | nd | 1.81 |
| Vinyl chloride | 2.67 | 5.28 | 0.18 |
| Chloroethane | 3.33 | 8.68 | 0.52 |
| Methylene chloride | 5.25 | 10.1 | 0.25 |
| Trichlorofluoromethane | 7.18 | nd | nd |
| 1,1-Dichloroethene | 7.93 | 7.72 | 0.13 |
| 1,1-Dichloroethane | 9.30 | 12.6 | 0.07 |
| trans-1,2-Dichloroethene | 10.1 | 9.38 | 0.10 |
| Chloroform | 10.7 | 12.1 | 0.05 |
| 1,2-Dichloroethane | 11.4 | 15.4 | 0.03 |
| 1,1,1-Trichloroethane | 12.6 | 13.1 | 0.03 |
| Carbon tetrachloride | 13.0 | 14.4 | 0.12 |
| Bromodichloromethane | 13.7 | 14.6 | 0.10 |
| 1,2-Dichloropropane | 14.9 | 16.6 | 0.04 |
| cis-1,3-Dichloropropene | 15.2 | 16.6 | 0.34 |
| Trichloroethene | 15.8 | 13.1 | 0.12 |
| Dibromochloromethane | 16.5 | 16.6 | 0.09 |

TABLE 1—CHROMATOGRAPHIC CONDITIONS AND METHOD DETECTION LIMITS—Continued

| Parameter | Retention time (min) | | Method detection limit (µg/L) |
|---------------------------------|----------------------|----------|-------------------------------|
| | Column 1 | Column 2 | |
| 1,1,2-Trichloroethane | 16.5 | 18.1 | 0.02 |
| trans-1,3-Dichloropropene | 16.5 | 18.0 | 0.20 |
| 2-Chloroethylvinyl ether | 18.0 | nd | 0.13 |
| Bromoform | 19.2 | 19.2 | 0.20 |
| 1,1,2,2-Tetrachloroethane | 21.6 | nd | 0.03 |
| Tetrachloroethene | 21.7 | 15.0 | 0.03 |
| Chlorobenzene | 24.2 | 18.8 | 0.25 |
| 1,3-Dichlorobenzene | 34.0 | 22.4 | 0.32 |
| 1,2-Dichlorobenzene | 34.9 | 23.5 | 0.15 |
| 1,4-Dichlorobenzene | 35.4 | 22.3 | 0.24 |

Column 1 conditions: Carboxpack B (60/80 mesh) coated with 1% SP-1000 packed in an 8 ft x 0.1 in. ID stainless steel or glass column with helium carrier gas at 40 mL/min flow rate. Column temperature held at 45 °C for 3 min then programmed at 8 °C/min to 220 °C and held for 15 min.

Column 2 conditions: Porisil-C (100/120 mesh) coated with n-octane packed in a 6 ft x 0.1 in. ID stainless steel or glass column with helium carrier gas at 40 mL/min flow rate. Column temperature held at 50 °C for 3 min then programmed at 6 °C/min to 170 °C and held for 4 min.

nd=not determined.

TABLE 2—CALIBRATION AND QC ACCEPTANCE CRITERIA—METHOD 601^A

| Parameter | Range for Q (µg/L) | Limit for s (µg/L) | Range for \bar{X} (µg/L) | Range P, P _s (%) |
|---------------------------------|--------------------|--------------------|----------------------------|-----------------------------|
| Bromodichloromethane | 15.2–24.8 | 4.3 | 10.7–32.0 | 42–172 |
| Bromoform | 14.7–25.3 | 4.7 | 5.0–29.3 | 13–159 |
| Bromomethane | 11.7–28.3 | 7.6 | 3.4–24.5 | D–144 |
| Carbon tetrachloride | 13.7–26.3 | 5.6 | 11.8–25.3 | 43–143 |
| Chlorobenzene | 14.4–25.6 | 5.0 | 10.2–27.4 | 38–150 |
| Chloroethane | 15.4–24.6 | 4.4 | 11.3–25.2 | 46–137 |
| 2-Chloroethylvinyl ether | 12.0–28.0 | 8.3 | 4.5–35.5 | 14–186 |
| Chloroform | 15.0–25.0 | 4.5 | 12.4–24.0 | 49–133 |
| Chloromethane | 11.9–28.1 | 7.4 | D–34.9 | D–193 |
| Dibromochloromethane | 13.1–26.9 | 6.3 | 7.9–35.1 | 24–191 |
| 1,2-Dichlorobenzene | 14.0–26.0 | 5.5 | 1.7–38.9 | D–208 |
| 1,3-Dichlorobenzene | 9.9–30.1 | 9.1 | 6.2–32.6 | 7–187 |
| 1,4-Dichlorobenzene | 13.9–26.1 | 5.5 | 11.5–25.5 | 42–143 |
| 1,1-Dichloroethane | 16.8–23.2 | 3.2 | 11.2–24.6 | 47–132 |
| 1,2-Dichloroethane | 14.3–25.7 | 5.2 | 13.0–26.5 | 51–147 |
| 1,1-Dichloroethene | 12.6–27.4 | 6.6 | 10.2–27.3 | 28–167 |
| trans-1,2-Dichloroethene | 12.8–27.2 | 6.4 | 11.4–27.1 | 38–155 |
| 1,2-Dichloropropane | 14.8–25.2 | 5.2 | 10.1–29.9 | 44–156 |
| cis-1,3-Dichloropropene | 12.8–27.2 | 7.3 | 6.2–33.8 | 22–178 |
| trans-1,3-Dichloropropene | 12.8–27.2 | 7.3 | 6.2–33.8 | 22–178 |
| Methylene chloride | 15.5–24.5 | 4.0 | 7.0–27.6 | 25–162 |
| 1,1,2,2-Tetrachloroethane | 9.8–30.2 | 9.2 | 6.6–31.8 | 8–184 |
| Tetrachloroethene | 14.0–26.0 | 5.4 | 8.1–29.6 | 26–162 |
| 1,1,1-Trichloroethane | 14.2–25.8 | 4.9 | 10.8–24.8 | 41–138 |
| 1,1,2-Trichloroethane | 15.7–24.3 | 3.9 | 9.6–25.4 | 39–136 |
| Trichloroethene | 15.4–24.6 | 4.2 | 9.2–26.6 | 35–146 |
| Trichlorofluoromethane | 13.3–26.7 | 6.0 | 7.4–28.1 | 21–156 |
| Vinyl chloride | 13.7–26.3 | 5.7 | 8.2–29.9 | 28–163 |

^a Criteria were calculated assuming a QC check sample concentration of 20 µg/L.

Q=Concentration measured in QC check sample, in µg/L (Section 7.5.3).

s=Standard deviation of four recovery measurements, in µg/L (Section 8.2.4).

\bar{X} =Average recovery for four recovery measurements, in µg/L (Section 8.2.4).

P, P_s=Percent recovery measured (Section 8.3.2, Section 8.4.2).

D=Detected; result must be greater than zero.

NOTE: These criteria are based directly upon the method performance data in Table 3. Where necessary, the limits for recovery have been broadened to assure applicability of the limits to concentrations below those used to develop Table 3.

TABLE 3—METHOD ACCURACY AND PRECISION AS FUNCTIONS OF CONCENTRATION—METHOD 601

| Parameter | Accuracy, as recovery, \bar{X} (µg/L) | Single analyst precision, s _i (µg/L) | Overall precision, S _r (µg/L) |
|----------------------------|---|---|--|
| Bromodichloromethane | 1.12C – 1.02 | 0.11 \bar{X} +0.04 | 0.20 \bar{X} +1.00 |
| Bromoform | 0.96C – 2.05 | 0.12 \bar{X} +0.58 | 0.21 \bar{X} +2.41 |
| Bromomethane | 0.76C – 1.27 | 0.28 \bar{X} +0.27 | 0.36 \bar{X} +0.94 |
| Carbon tetrachloride | 0.98C – 1.04 | 0.15 \bar{X} +0.38 | 0.20 \bar{X} +0.39 |
| Chlorobenzene | 1.00C – 1.23 | 0.15 \bar{X} – 0.02 | 0.18 \bar{X} +1.21 |
| Chloroethane | 0.99C – 1.53 | 0.14 \bar{X} – 0.13 | 0.17 \bar{X} +0.63 |

TABLE 3—METHOD ACCURACY AND PRECISION AS FUNCTIONS OF CONCENTRATION—METHOD 601—
Continued

| Parameter | Accuracy, as re- covery, \bar{X}' ($\mu\text{g/L}$) | Single analyst pre- cision, s_i' ($\mu\text{g/L}$) | Overall precision, S' ($\mu\text{g/L}$) |
|--|--|---|--|
| 2-Chloroethylvinyl ether ^a | 1.00C | 0.20 \bar{X} | 0.35 \bar{X} |
| Chloroform | 0.93C - 0.39 | 0.13 \bar{X} +0.15 | 0.19 \bar{X} - 0.02 |
| Chloromethane | 0.77C+0.18 | 0.28 \bar{X} - 0.31 | 0.52 \bar{X} +1.31 |
| Dibromochloromethane | 0.94C+2.72 | 0.11 \bar{X} +1.10 | 0.24 \bar{X} +1.68 |
| 1,2-Dichlorobenzene | 0.93C+1.70 | 0.20 \bar{X} +0.97 | 0.13 \bar{X} +6.13 |
| 1,3-Dichlorobenzene | 0.95C+0.43 | 0.14 \bar{X} +2.33 | 0.26 \bar{X} +2.34 |
| 1,4-Dichlorobenzene | 0.93C - 0.09 | 0.15 \bar{X} +0.29 | 0.20 \bar{X} +0.41 |
| 1,1-Dichloroethane | 0.95C - 1.08 | 0.09 \bar{X} +0.17 | 0.14 \bar{X} +0.94 |
| 1,2-Dichloroethane | 1.04C - 1.06 | 0.11 \bar{X} +0.70 | 0.15 \bar{X} +0.94 |
| 1,1-Dichloroethene | 0.98C - 0.87 | 0.21 \bar{X} - 0.23 | 0.29 \bar{X} - 0.40 |
| trans-1,2-Dichloroethene | 0.97C - 0.16 | 0.11 \bar{X} +1.46 | 0.17 \bar{X} +1.46 |
| 1,2-Dichloropropane ^a | 1.00C | 0.13 \bar{X} | 0.23 \bar{X} |
| cis-1,3-Dichloropropene ^a | 1.00C | 0.18 \bar{X} | 0.32 \bar{X} |
| trans-1,3-Dichloropropene ^a | 1.00C | 0.18 \bar{X} | 0.32 \bar{X} |
| Methylene chloride | 0.91C - 0.93 | 0.11 \bar{X} +0.33 | 0.21 \bar{X} +1.43 |
| 1,1,2,2-Tetrachloroethene | 0.95C+0.19 | 0.14 \bar{X} +2.41 | 0.23 \bar{X} +2.79 |
| Tetrachloroethene | 0.94C+0.06 | 0.14 \bar{X} +0.38 | 0.18 \bar{X} +2.21 |
| 1,1,1-Trichloroethane | 0.90C - 0.16 | 0.15 \bar{X} +0.04 | 0.20 \bar{X} +0.37 |
| 1,1,2-Trichloroethane | 0.86C+0.30 | 0.13 \bar{X} - 0.14 | 0.19 \bar{X} +0.67 |
| Trichloroethene | 0.87C+0.48 | 0.13 \bar{X} - 0.03 | 0.23 \bar{X} +0.30 |
| Trichlorofluoromethane | 0.89C - 0.07 | 0.15 \bar{X} +0.67 | 0.26 \bar{X} +0.91 |
| Vinyl chloride | 0.97C - 0.36 | 0.13 \bar{X} +0.65 | 0.27 \bar{X} +0.40 |

\bar{X}' =Expected recovery for one or more measurements of a sample containing a concentration of C, in $\mu\text{g/L}$.

s_i' =Expected single analyst standard deviation of measurements at an average concentration found of \bar{X} , in $\mu\text{g/L}$.

S' =Expected interlaboratory standard deviation of measurements at an average concentration found of \bar{X} , in $\mu\text{g/L}$.

C=True value for the concentration, in $\mu\text{g/L}$.

\bar{X} =Average recovery found for measurements of samples containing a concentration of C, in $\mu\text{g/L}$.

^aEstimates based upon the performance in a single laboratory. ¹⁰

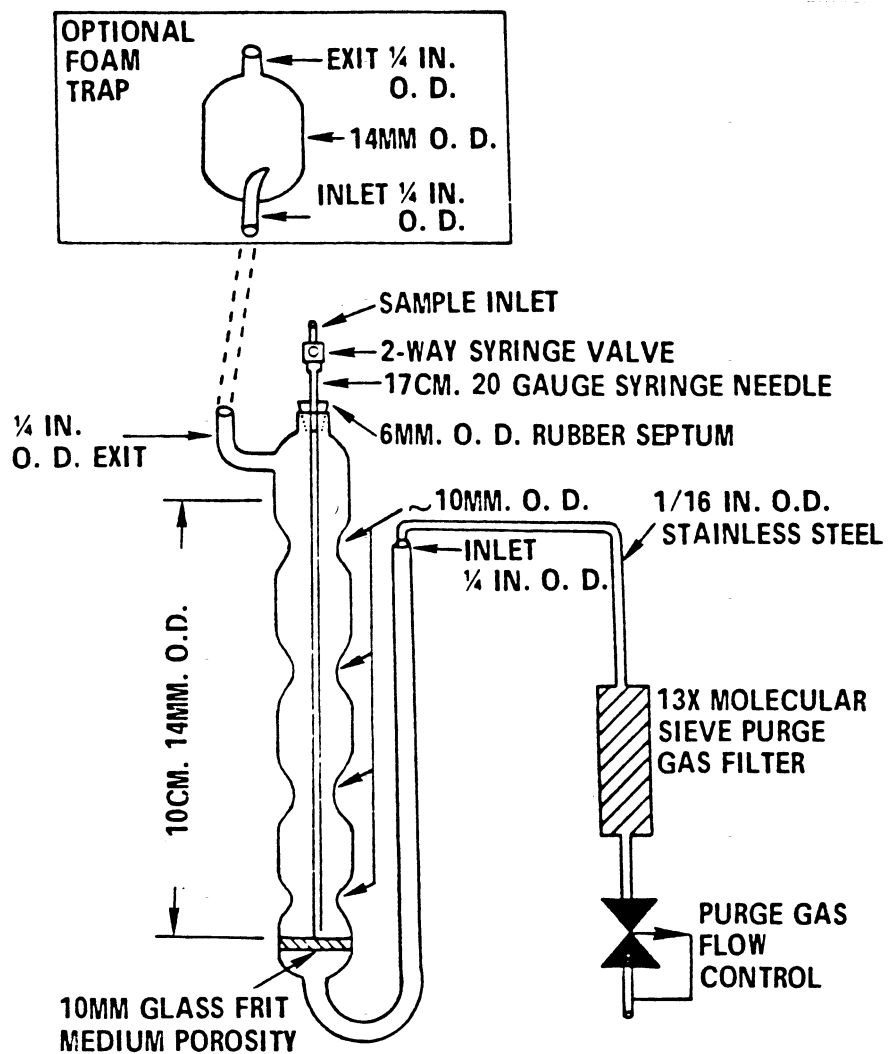

Figure 1. Purging device.

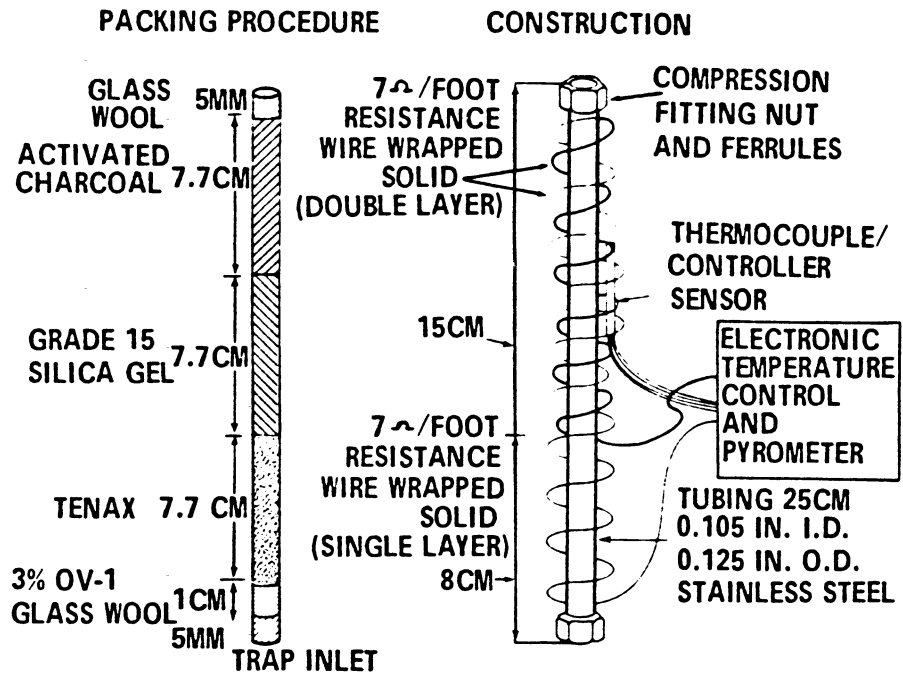

Figure 2. Trap packings and construction to include desorb capability

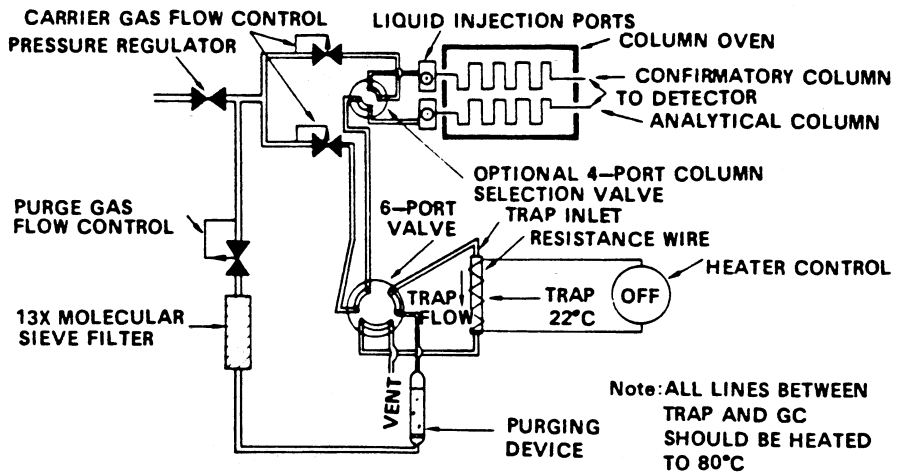

Figure 3. Purge and trap system-purge mode.

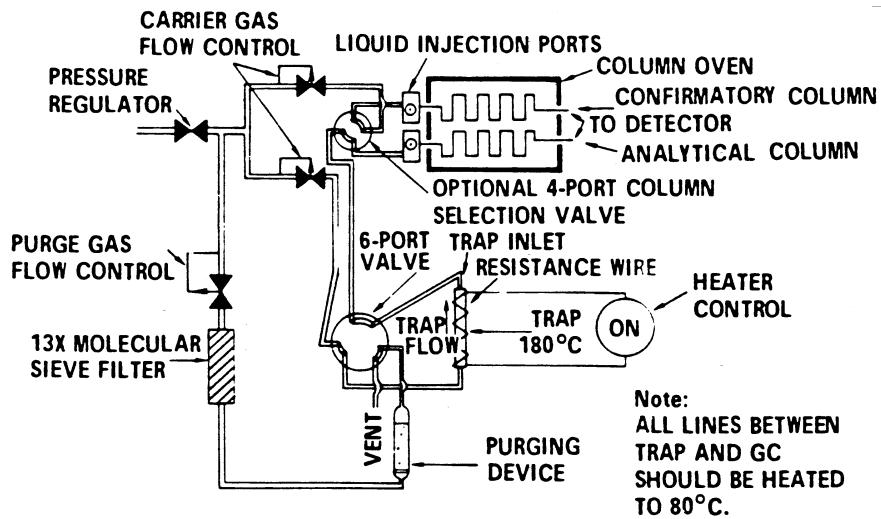

Figure 4. Purge and trap system - desorb mode.

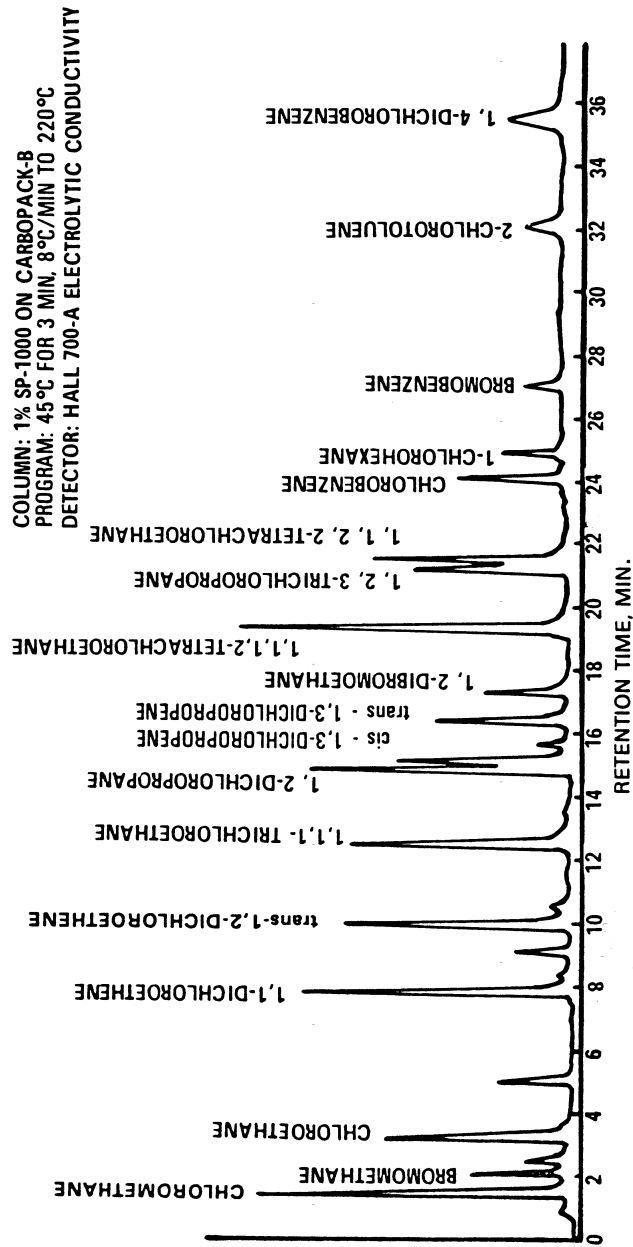

Figure 5. Gas chromatogram of purgable halocarbons.

METHOD 602—PURGEABLE AROMATICS

1. Scope and Application

1.1 This method covers the determination of various purgeable aromatics. The following parameters may be determined by this method:

| Parameter | STORET No. | CAS No. |
|---------------------------|------------|----------|
| Benzene | 34030 | 71-43-2 |
| Chlorobenzene | 34301 | 108-90-7 |
| 1,2-Dichlorobenzene | 34536 | 95-50-1 |
| 1,3-Dichlorobenzene | 34566 | 541-73-1 |
| 1,4-Dichlorobenzene | 34571 | 106-46-7 |
| Ethylbenzene | 34371 | 100-41-4 |
| Toluene | 34010 | 108-88-3 |

1.2 This is a purge and trap gas chromatographic (GC) method applicable to the determination of the compounds listed above in municipal and industrial discharges as provided under 40 CFR 136.1. When this method is used to analyze unfamiliar samples for any or all of the compounds above, compound identifications should be supported by at least one additional qualitative technique. This method describes analytical conditions for a second gas chromatographic column that can be used to confirm measurements made with the primary column. Method 624 provides gas chromatograph/mass spectrometer (GC/MS) conditions appropriate for the qualitative and quantitative confirmation of results for all of the parameters listed above.

1.3 The method detection limit (MDL, defined in Section 12.1)¹ for each parameter is listed in Table 1. The MDL for a specific wastewater may differ from those listed, depending upon the nature of interferences in the sample matrix.

1.4 Any modification of this method, beyond those expressly permitted, shall be considered as a major modification subject to application and approval of alternate test procedures under 40 CFR 136.4 and 136.5.

1.5 This method is restricted to use by or under the supervision of analysts experienced in the operation of a purge and trap system and a gas chromatograph and in the interpretation of gas chromatograms. Each analyst must demonstrate the ability to generate acceptable results with this method using the procedure described in Section 8.2.

2. Summary of Method

2.1 An inert gas is bubbled through a 5-mL water sample contained in a specially-designed purging chamber at ambient temperature. The aromatics are efficiently transferred from the aqueous phase to the vapor phase. The vapor is swept through a sorbent trap where the aromatics are trapped. After purging is completed, the trap is heated and backflushed with the inert gas to desorb the aromatics onto a gas chromatographic col-

umn. The gas chromatograph is temperature programmed to separate the aromatics which are then detected with a photoionization detector.^{2,3}

2.2 The method provides an optional gas chromatographic column that may be helpful in resolving the compounds of interest from interferences that may occur.

3. Interferences

3.1 Impurities in the purge gas and organic compounds outgassing from the plumbing ahead of the trap account for the majority of contamination problems. The analytical system must be demonstrated to be free from contamination under the conditions of the analysis by running laboratory reagent blanks as described in Section 8.1.3. The use of non-Teflon plastic tubing, non-Teflon thread sealants, or flow controllers with rubber components in the purge and trap system should be avoided.

3.2 Samples can be contaminated by diffusion of volatile organics through the septum seal into the sample during shipment and storage. A field reagent blank prepared from reagent water and carried through the sampling and handling protocol can serve as a check on such contamination.

3.3 Contamination by carry-over can occur whenever high level and low level samples are sequentially analyzed. To reduce carry-over, the purging device and sample syringe must be rinsed with reagent water between sample analyses. Whenever an unusually concentrated sample is encountered, it should be followed by an analysis of reagent water to check for cross contamination. For samples containing large amounts of water-soluble materials, suspended solids, high boiling compounds or high aromatic levels, it may be necessary to wash the purging device with a detergent solution, rinse it with distilled water, and then dry it in an oven at 105°C between analyses. The trap and other parts of the system are also subject to contamination; therefore, frequent bakeout and purging of the entire system may be required.

4. Safety

4.1 The toxicity or carcinogenicity of each reagent used in this method has not been precisely defined; however, each chemical compound should be treated as a potential health hazard. From this viewpoint, exposure to these chemicals must be reduced to the lowest possible level by whatever means available. The laboratory is responsible for maintaining a current awareness file of OSHA regulations regarding the safe handling of the chemicals specified in this method. A reference file of material data handling sheets should also be made available to all personnel involved in the chemical analysis. Additional references to laboratory safety

are available and have been identified^{4,6} for the information of the analyst.

4.2 The following parameters covered by this method have been tentatively classified as known or suspected, human or mammalian carcinogens: benzene and 1,4-dichlorobenzene. Primary standards of these toxic compounds should be prepared in a hood. A NIOSH/MESA approved toxic gas respirator should be worn when the analyst handles high concentrations of these toxic compounds.

5. Apparatus and Materials

5.1 Sampling equipment, for discrete sampling.

5.1.1 Vial—25-mL capacity or larger, equipped with a screw cap with a hole in the center (Pierce #13075 or equivalent). Detergent wash, rinse with tap and distilled water, and dry at 105 °C before use.

5.1.2 Septum—Teflon-faced silicone (Pierce #12722 or equivalent). Detergent wash, rinse with tap and distilled water, and dry at 105 °C for 1 h before use.

5.2 Purge and trap system—The purge and trap system consists of three separate pieces of equipment: A purging device, trap, and desorber. Several complete systems are now commercially available.

5.2.1 The purging device must be designed to accept 5-mL samples with a water column at least 3 cm deep. The gaseous head space between the water column and the trap must have a total volume of less than 15 mL. The purge gas must pass through the water column as finely divided bubbles with a diameter of less than 3 mm at the origin. The purge gas must be introduced no more than 5 mm from the base of the water column. The purging device illustrated in Figure 1 meets these design criteria.

5.2.2 The trap must be at least 25 cm long and have an inside diameter of at least 0.105 in.

5.2.2.1 The trap is packed with 1 cm of methyl silicone coated packing (Section 6.4.2) and 23 cm of 2,6-diphenylene oxide polymer (Section 6.4.1) as shown in Figure 2. This trap was used to develop the method performance statements in Section 12.

5.2.2.2 Alternatively, either of the two traps described in Method 601 may be used, although water vapor will preclude the measurement of low concentrations of benzene.

5.2.3 The desorber must be capable of rapidly heating the trap to 180 °C. The polymer section of the trap should not be heated higher than 180 °C and the remaining sections should not exceed 200 °C. The desorber illustrated in Figure 2 meets these design criteria.

5.2.4 The purge and trap system may be assembled as a separate unit or be coupled to a gas chromatograph as illustrated in Figures 3, 4, and 5.

5.3 Gas chromatograph—An analytical system complete with a temperature programmable gas chromatograph suitable for on-column injection and all required accessories including syringes, analytical columns, gases, detector, and strip-chart recorder. A data system is recommended for measuring peak areas.

5.3.1 Column 1—6 ft long × 0.082 in. ID stainless steel or glass, packed with 5% SP-1200 and 1.75% Bentone-34 on Supelcoport (100/120 mesh) or equivalent. This column was used to develop the method performance statements in Section 12. Guidelines for the use of alternate column packings are provided in Section 10.1.

5.3.2 Column 2—8 ft long × 0.1 in ID stainless steel or glass, packed with 5% 1,2,3-Tris(2-cyanoethoxy)propane on Chromosorb W-AW (60/80 mesh) or equivalent.

5.3.3 Detector—Photoionization detector (h-Nu Systems, Inc. Model PI-51-02 or equivalent). This type of detector has been proven effective in the analysis of wastewaters for the parameters listed in the scope (Section 1.1), and was used to develop the method performance statements in Section 12. Guidelines for the use of alternate detectors are provided in Section 10.1.

5.4 Syringes—5-mL glass hypodermic with Luerlok tip (two each), if applicable to the purging device.

5.5 Micro syringes—25- μ L, 0.006 in. ID needle.

5.6 Syringe valve—2-way, with Luer ends (three each).

5.7 Bottle—15-mL, screw-cap, with Teflon cap liner.

5.8 Balance—Analytical, capable of accurately weighing 0.0001 g.

6. Reagents

6.1 Reagent water—Reagent water is defined as a water in which an interferent is not observed at the MDL of the parameters of interest.

6.1.1 Reagent water can be generated by passing tap water through a carbon filter bed containing about 1 lb of activated carbon (Filtrisorb-300, Calgon Corp., or equivalent).

6.1.2 A water purification system (Millipore Super-Q or equivalent) may be used to generate reagent water.

6.1.3 Reagent water may also be prepared by boiling water for 15 min. Subsequently, while maintaining the temperature at 90 °C, bubble a contaminant-free inert gas through the water for 1 h. While still hot, transfer the water to a narrow mouth screw-cap bottle and seal with a Teflon-lined septum and cap.

6.2 Sodium thiosulfate—(ACS) Granular.

6.3 Hydrochloric acid (1+1)—Add 50 mL of concentrated HCl (ACS) to 50 mL of reagent water.

6.4 Trap Materials:

6.4.1 2,6-Diphenylene oxide polymer—Tenax, (60/80 mesh), chromatographic grade or equivalent.

6.4.2 Methyl silicone packing—3% OV-1 on Chromosorb-W (60/80 mesh) or equivalent.

6.5 Methanol—Pesticide quality or equivalent.

6.6 Stock standard solutions—Stock standard solutions may be prepared from pure standard materials or purchased as certified solutions. Prepare stock standard solutions in methanol using assayed liquids. Because of the toxicity of benzene and 1,4-dichlorobenzene, primary dilutions of these materials should be prepared in a hood. A NIOSH/MESA approved toxic gas respirator should be used when the analyst handles high concentrations of such materials.

6.6.1 Place about 9.8 mL of methanol into a 10-mL ground glass stoppered volumetric flask. Allow the flask to stand, unstoppered, for about 10 min or until all alcohol wetted surfaces have dried. Weigh the flask to the nearest 0.1 mg.

6.6.2 Using a 100- μ L syringe, immediately add two or more drops of assayed reference material to the flask, then reweigh. Be sure that the drops fall directly into the alcohol without contacting the neck of the flask.

6.6.3 Reweigh, dilute to volume, stopper, then mix by inverting the flask several times. Calculate the concentration in μ g/ μ L from the net gain in weight. When compound purity is assayed to be 96% or greater, the weight can be used without correction to calculate the concentration of the stock standard. Commercially prepared stock standards can be used at any concentration if they are certified by the manufacturer or by an independent source.

6.6.4 Transfer the stock standard solution into a Teflon-sealed screw-cap bottle. Store at 4 °C and protect from light.

6.6.5 All standards must be replaced after one month, or sooner if comparison with check standards indicates a problem.

6.7 Secondary dilution standards—Using stock standard solutions, prepare secondary dilution standards in methanol that contain the compounds of interest, either singly or mixed together. The secondary dilution standards should be prepared at concentrations such that the aqueous calibration standards prepared in Section 7.3.1 or 7.4.1 will bracket the working range of the analytical system. Secondary solution standards must be stored with zero headspace and should be checked frequently for signs of degradation or evaporation, especially just prior to preparing calibration standards from them.

6.8 Quality control check sample concentrate—See Section 8.2.1.

7. Calibration

7.1 Assemble a purge and trap system that meets the specifications in Section 5.2. Con-

dition the trap overnight at 180 °C by backflushing with an inert gas flow of at least 20 mL/min. Condition the trap for 10 min once daily prior to use.

7.2 Connect the purge and trap system to a gas chromatograph. The gas chromatograph must be operated using temperature and flow rate conditions equivalent to those given in Table 1. Calibrate the purge and trap-gas chromatographic system using either the external standard technique (Section 7.3) or the internal standard technique (Section 7.4).

7.3 External standard calibration procedure:

7.3.1 Prepare calibration standards at a minimum of three concentration levels for each parameter by carefully adding 20.0 μ L of one or more secondary dilution standards to 100, 500, or 1000 mL of reagent water. A 25- μ L syringe with a 0.006 in. ID needle should be used for this operation. One of the external standards should be at a concentration near, but above, the MDL (Table 1) and the other concentrations should correspond to the expected range of concentrations found in real samples or should define the working range of the detector. These aqueous standards must be prepared fresh daily.

7.3.2 Analyze each calibration standard according to Section 10, and tabulate peak height or area responses versus the concentration in the standard. The results can be used to prepare a calibration curve for each compound. Alternatively, if the ratio of response to concentration (calibration factor) is a constant over the working range (<10% relative standard deviation, RSD), linearity through the origin can be assumed and the average ratio or calibration factor can be used in place of a calibration curve.

7.4 Internal standard calibration procedure—To use this approach, the analyst must select one or more internal standards that are similar in analytical behavior to the compounds of interest. The analyst must further demonstrate that the measurement of the internal standard is not affected by method or matrix interferences. Because of these limitations, no internal standard can be suggested that is applicable to all samples. The compound, α,α,α -trifluorotoluene, recommended as a surrogate spiking compound in Section 8.7 has been used successfully as an internal standard.

7.4.1 Prepare calibration standards at a minimum of three concentration levels for each parameter of interest as described in Section 7.3.1.

7.4.2 Prepare a spiking solution containing each of the internal standards using the procedures described in Sections 6.6 and 6.7. It is recommended that the secondary dilution standard be prepared at a concentration of 15 μ g/mL of each internal standard compound. The addition of 10 μ L of this

standard to 5.0 mL of sample or calibration standard would be equivalent to 30 µg/L.

7.4.3 Analyze each calibration standard according to Section 10, adding 10 µL of internal standard spiking solution directly to the syringe (Section 10.4). Tabulate peak height or area responses against concentration for each compound and internal standard, and calculate response factors (RF) for each compound using Equation 1.

$$RF = (A_s)(C_{is}) / (A_{is})(C_s)$$

Equation 1

where:

A_s =Response for the parameter to be measured.

A_{is} =Response for the internal standard.

C_{is} =Concentration of the internal standard

C_s =Concentration of the parameter to be measured.

If the RF value over the working range is a constant (<10% RSD), the RF can be assumed to be invariant and the average RF can be used for calculations. Alternatively, the results can be used to plot a calibration curve of response ratios, A_s/A_{is} , vs. RF.

7.5 The working calibration curve, calibration factor, or RF must be verified on each working day by the measurement of a QC check sample.

7.5.1 Prepare the QC check sample as described in Section 8.2.2.

7.5.2 Analyze the QC check sample according to Section 10.

7.5.3 For each parameter, compare the response (Q) with the corresponding calibration acceptance criteria found in Table 2. If the responses for all parameters of interest fall within the designated ranges, analysis of actual samples can begin. If any individual Q falls outside the range, a new calibration curve, calibration factor, or RF must be prepared for that parameter according to Section 7.3 or 7.4.

8. Quality Control

8.1 Each laboratory that uses this method is required to operate a formal quality control program. The minimum requirements of this program consist of an initial demonstration of laboratory capability and an ongoing analysis of spiked samples to evaluate and document data quality. The laboratory must maintain records to document the quality of data that is generated. Ongoing data quality checks are compared with established performance criteria to determine if the results of analyses meet the performance characteristics of the method. When results of sample spikes indicate atypical method performance, a quality control check standard must be analyzed to confirm that the measurements were performed in an in-control mode of operation.

8.1.1 The analyst must make an initial, one-time, demonstration of the ability to

generate acceptable accuracy and precision with this method. This ability is established as described in Section 8.2.

8.1.2 In recognition of advances that are occurring in chromatography, the analyst is permitted certain options (detailed in Section 10.1) to improve the separations or lower the cost of measurements. Each time such a modification is made to the method, the analyst is required to repeat the procedure in Section 8.2.

8.1.3 Each day, the analyst must analyze a reagent water blank to demonstrate that interferences from the analytical system are under control.

8.1.4 The laboratory must, on an ongoing basis, spike and analyze a minimum of 10% of all samples to monitor and evaluate laboratory data quality. This procedure is described in Section 8.3.

8.1.5 The laboratory must, on an ongoing basis, demonstrate through the analyses of quality control check standards that the operation of the measurement system is in control. This procedure is described in Section 8.4. The frequency of the check standard analyses is equivalent to 10% of all samples analyzed but may be reduced if spike recoveries from samples (Section 8.3) meet all specified quality control criteria.

8.1.6 The laboratory must maintain performance records to document the quality of data that is generated. This procedure is described in Section 8.5.

8.2 To establish the ability to generate acceptable accuracy and precision, the analyst must perform the following operations.

8.2.1 A quality control (QC) check sample concentrate is required containing each parameter of interest at a concentration of 10 µg/mL in methanol. The QC check sample concentrate must be obtained from the U.S. Environmental Protection Agency, Environmental Monitoring and Support Laboratory in Cincinnati, Ohio, if available. If not available from that source, the QC check sample concentrate must be obtained from another external source. If not available from either source above, the QC check sample concentrate must be prepared by the laboratory using stock standards prepared independently from those used for calibration.

8.2.2 Prepare a QC check sample to contain 20 µg/L of each parameter by adding 200 µL of QC check sample concentrate to 100 mL of reagent water.

8.2.3 Analyze four 5-mL aliquots of the well-mixed QC check sample according to Section 10.

8.2.4 Calculate the average recovery (\bar{X}) in µg/L, and the standard deviation of the recovery (s) in µg/L, for each parameter of interest using the four results.

8.2.5 For each parameter compare s and \bar{X} with the corresponding acceptance criteria for precision and accuracy, respectively,

found in Table 2. If s and \bar{X} for all parameters of interest meet the acceptance criteria, the system performance is acceptable and analysis of actual samples can begin. If any individual s exceeds the precision limit or any individual \bar{X} falls outside the range for accuracy, the system performance is unacceptable for that parameter.

NOTE: The large number of parameters in Table 2 present a substantial probability that one or more will fail at least one of the acceptance criteria when all parameters are analyzed.

8.2.6 When one or more of the parameters tested fail at least one of the acceptance criteria, the analyst must proceed according to Section 8.2.6.1 or 8.2.6.2.

8.2.6.1 Locate and correct the source of the problem and repeat the test for all parameters of interest beginning with Section 8.2.3.

8.2.6.2 Beginning with Section 8.2.3, repeat the test only for those parameters that failed to meet criteria. Repeated failure, however, will confirm a general problem with the measurement system. If this occurs, locate and correct the source of the problem and repeat the test for all compounds of interest beginning with Section 8.2.3.

8.3 The laboratory must, on an ongoing basis, spike at least 10% of the samples from each sample site being monitored to assess accuracy. For laboratories analyzing one to ten samples per month, at least one spiked sample per month is required.

8.3.1 The concentration of the spike in the sample should be determined as follows:

8.3.1.1 If, as in compliance monitoring, the concentration of a specific parameter in the sample is being checked against a regulatory concentration limit, the spike should be at that limit or 1 to 5 times higher than the background concentration determined in Section 8.3.2, whichever concentration would be larger.

8.3.1.2 If the concentration of a specific parameter in the sample is not being checked against a limit specific to that parameter, the spike should be at 20 $\mu\text{g/L}$ or 1 to 5 times higher than the background concentration determined in Section 8.3.2, whichever concentration would be larger.

8.3.2 Analyze one 5-mL sample aliquot to determine the background concentration (B) of each parameter. If necessary, prepare a new QC check sample concentrate (Section 8.2.1) appropriate for the background concentrations in the sample. Spike a second 5-mL sample aliquot with 10 μL of the QC check sample concentrate and analyze it to determine the concentration after spiking (A) of each parameter. Calculate each percent recovery (P) as $100(A - B)\%/T$, where T is the known true value of the spike.

8.3.3 Compare the percent recovery (P) for each parameter with the corresponding QC acceptance criteria found in Table 2. These

acceptance criteria were calculated to include an allowance for error in measurement of both the background and spike concentrations, assuming a spike to background ratio of 5:1. This error will be accounted for to the extent that the analyst's spike to background ratio approaches 5:1.⁷ If spiking was performed at a concentration lower than 20 $\mu\text{g/L}$, the analyst must use either the QC acceptance criteria in Table 2, or optional QC acceptance criteria calculated for the specific spike concentration. To calculate optional acceptance criteria for the recovery of a parameter: (1) Calculate accuracy (X') using the equation in Table 3, substituting the spike concentration (T) for C; (2) calculate overall precision (S') using the equation in Table 3, substituting X' for \bar{X} ; (3) calculate the range for recovery at the spike concentration as $(100 X'/T) \pm 2.44(100 S'/T)\%$.⁷

8.3.4 If any individual P falls outside the designated range for recovery, that parameter has failed the acceptance criteria. A check standard containing each parameter that failed the criteria must be analyzed as described in Section 8.4.

8.4 If any parameter fails the acceptance criteria for recovery in Section 8.3, a QC check standard containing each parameter that failed must be prepared and analyzed.

NOTE: The frequency for the required analysis of a QC check standard will depend upon the number of parameters being simultaneously tested, the complexity of the sample matrix, and the performance of the laboratory.

8.4.1 Prepare the QC check standard by adding 10 μL of QC check sample concentrate (Section 8.2.1 or 8.3.2) to 5 mL of reagent water. The QC check standard needs only to contain the parameters that failed criteria in the test in Section 8.3.

8.4.2 Analyze the QC check standard to determine the concentration measured (A) of each parameter. Calculate each percent recovery (P_s) as $100(A/T)\%$, where T is the true value of the standard concentration.

8.4.3 Compare the percent recovery (P_s) for each parameter with the corresponding QC acceptance criteria found in Table 2. Only parameters that failed the test in Section 8.3 need to be compared with these criteria. If the recovery of any such parameter falls outside the designated range, the laboratory performance for that parameter is judged to be out of control, and the problem must be immediately identified and corrected. The analytical result for that parameter in the unspiked sample is suspect and may not be reported for regulatory compliance purposes.

8.5 As part of the QC program for the laboratory, method accuracy for wastewater samples must be assessed and records must be maintained. After the analysis of five spiked wastewater samples as in Section 8.3, calculate the average percent recovery (P)

and the standard deviation of the percent recovery (s_p). Express the accuracy assessment as a percent recovery interval from $\bar{P} - 2s_p$ to $\bar{P} + 2s_p$. If $\bar{P}=90\%$ and $s_p=10\%$, for example, the accuracy interval is expressed as 70–110%. Update the accuracy assessment for each parameter on a regular basis (e.g. after each five to ten new accuracy measurements).

8.6 It is recommended that the laboratory adopt additional quality assurance practices for use with this method. The specific practices that are most productive depend upon the needs of the laboratory and the nature of the samples. Field duplicates may be analyzed to assess the precision of the environmental measurements. When doubt exists over the identification of a peak on the chromatogram, confirmatory techniques such as gas chromatography with a dissimilar column, specific element detector, or mass spectrometer must be used. Whenever possible, the laboratory should analyze standard reference materials and participate in relevant performance evaluation studies.

8.7 The analyst should monitor both the performance of the analytical system and the effectiveness of the method in dealing with each sample matrix by spiking each sample, standard, and reagent water blank with surrogate compounds (e.g. α , α , α -trifluorotoluene) that encompass the range of the temperature program used in this method. From stock standard solutions prepared as in Section 6.6, add a volume to give 750 μg of each surrogate to 45 mL of reagent water contained in a 50-mL volumetric flask, mix and dilute to volume for a concentration of 15 mg/ μL . Add 10 μL of this surrogate spiking solution directly into the 5-mL syringe with every sample and reference standard analyzed. Prepare a fresh surrogate spiking solution on a weekly basis. If the internal standard calibration procedure is being used, the surrogate compounds may be added directly to the internal standard spiking solution (Section 7.4.2).

9. Sample Collection, Preservation, and Handling

9.1 The samples must be iced or refrigerated from the time of collection until analysis. If the sample contains free or combined chlorine, add sodium thiosulfate preservative (10 mg/40 mL is sufficient for up to 5 ppm Cl_2) to the empty sample bottle just prior to shipping to the sampling site. EPA Method 330.4 or 330.5 may be used for measurement of residual chlorine.⁸ Field test kits are available for this purpose.

9.2 Collect about 500 mL of sample in a clean container. Adjust the pH of the sample to about 2 by adding 1+1 HCl while stirring. Fill the sample bottle in such a manner that no air bubbles pass through the sample as the bottle is being filled. Seal the bottle so that no air bubbles are entrapped in it. Main-

tain the hermetic seal on the sample bottle until time of analysis.

9.3 All samples must be analyzed within 14 days of collection.³

10. Procedure

10.1 Table 1 summarizes the recommended operating conditions for the gas chromatograph. Included in this table are estimated retention times and MDL that can be achieved under these conditions. An example of the separations achieved by Column 1 is shown in Figure 6. Other packed columns, chromatographic conditions, or detectors may be used if the requirements of Section 8.2 are met.

10.2 Calibrate the system daily as described in Section 7.

10.3 Adjust the purge gas (nitrogen or helium) flow rate to 40 mL/min. Attach the trap inlet to the purging device, and set the purge and trap system to purge (Figure 3). Open the syringe valve located on the purging device sample introduction needle.

10.4 Allow the sample to come to ambient temperature prior to introducing it to the syringe. Remove the plunger from a 5-mL syringe and attach a closed syringe valve. Open the sample bottle (or standard) and carefully pour the sample into the syringe barrel to just short of overflowing. Replace the syringe plunger and compress the sample. Open the syringe valve and vent any residual air while adjusting the sample volume to 5.0 mL. Since this process of taking an aliquot destroys the validity of the sample for future analysis, the analyst should fill a second syringe at this time to protect against possible loss of data. Add 10.0 μL of the surrogate spiking solution (Section 8.7) and 10.0 μL of the internal standard spiking solution (Section 7.4.2), if applicable, through the valve bore, then close the valve.

10.5 Attach the syringe-syringe valve assembly to the syringe valve on the purging device. Open the syringe valves and inject the sample into the purging chamber.

10.6 Close both valves and purge the sample for 12.0 \pm 0.1 min at ambient temperature.

10.7 After the 12-min purge time, disconnect the purging device from the trap. Dry the trap by maintaining a flow of 40 mL/min of dry purge gas through it for 6 min (Figure 4). If the purging device has no provision for bypassing the purger for this step, a dry purger should be inserted into the device to minimize moisture in the gas. Attach the trap to the chromatograph, adjust the purge and trap system to the desorb mode (Figure 5), and begin to temperature program the gas chromatograph. Introduce the trapped materials to the GC column by rapidly heating the trap to 180 °C while backflushing the trap with an inert gas between 20 and 60 mL/min for 4 min. If rapid heating of the trap cannot be achieved, the GC column must be used as

a secondary trap by cooling it to 30 °C (sub-ambient temperature, if poor peak geometry and random retention time problems persist) instead of the initial program temperature of 50 °C.

10.8 While the trap is being desorbed into the gas chromatograph column, empty the purging chamber using the sample introduction syringe. Wash the chamber with two 5-mL flushes of reagent water.

10.9 After desorbing the sample for 4 min, recondition the trap by returning the purge and trap system to the purge mode. Wait 15 s, then close the syringe valve on the purging device to begin gas flow through the trap. The trap temperature should be maintained at 180 °C. After approximately 7 min, turn off the trap heater and open the syringe valve to stop the gas flow through the trap. When the trap is cool, the next sample can be analyzed.

10.10 Identify the parameters in the sample by comparing the retention times of the peaks in the sample chromatogram with those of the peaks in standard chromatograms. The width of the retention time window used to make identifications should be based upon measurements of actual retention time variations of standards over the course of a day. Three times the standard deviation of a retention time for a compound can be used to calculate a suggested window size; however, the experience of the analyst should weigh heavily in the interpretation of chromatograms.

10.11 If the response for a peak exceeds the working range of the system, prepare a dilution of the sample with reagent water from the aliquot in the second syringe and reanalyze.

11. Calculations

11.1 Determine the concentration of individual compounds in the sample.

11.1.1 If the external standard calibration procedure is used, calculate the concentration of the parameter being measured from the peak response using the calibration curve or calibration factor determined in Section 7.3.2.

11.1.2 If the internal standard calibration procedure is used, calculate the concentration in the sample using the response factor (RF) determined in Section 7.4.3 and Equation 2.

$$\text{Concentration } (\mu\text{g/L}) = \frac{(A_s)(C_{is})}{(A_{is})(\text{RF})}$$

Equation 2

where:

A_s = Response for the parameter to be measured.

A_{is} = Response for the internal standard.

C_{is} = Concentration of the internal standard.

11.2 Report results in $\mu\text{g/L}$ without correction for recovery data. All QC data obtained should be reported with the sample results.

12. Method Performance

12.1 The method detection limit (MDL) is defined as the minimum concentration of a substance that can be measured and reported with 99% confidence that the value is above zero.¹ The MDL concentrations listed in Table 1 were obtained using reagent water.⁹ Similar results were achieved using representative wastewaters. The MDL actually achieved in a given analysis will vary depending on instrument sensitivity and matrix effects.

12.2 This method has been demonstrated to be applicable for the concentration range from the MDL to 100 \times MDL.⁹ Direct aqueous injection techniques should be used to measure concentration levels above 1000 \times MDL.

12.3 This method was tested by 20 laboratories using reagent water, drinking water, surface water, and three industrial wastewaters spiked at six concentrations over the range 2.1 to 550 $\mu\text{g/L}$.⁹ Single operator precision, overall precision, and method accuracy were found to be directly related to the concentration of the parameter and essentially independent of the sample matrix. Linear equations to describe these relationships are presented in Table 3.

References

- 40 CFR part 136, appendix B.
- Lichtenberg, J.J. "Determining Volatile Organics at Microgram-per-Litre-Levels by Gas Chromatography," *Journal American Water Works Association*, 66, 739 (1974).
- Bellar, T.A., and Lichtenberg, J.J. "Semi-Automated Headspace Analysis of Drinking Waters and Industrial Waters for Purgeable Volatile Organic Compounds," *Proceedings of Symposium on Measurement of Organic Pollutants in Water and Wastewater*. American Society for Testing and Materials, STP 686, C.E. Van Hall, editor, 1978.
- "Carcinogens—Working with Carcinogens," Department of Health, Education, and Welfare, Public Health Service, Center for Disease Control, National Institute for Occupational Safety and Health. Publication No. 77-206, August 1977.
- "OSHA Safety and Health Standards, General Industry," (29 CFR part 1910), Occupational Safety and Health Administration, OSHA 2206 (Revised, January 1976).
- "Safety in Academic Chemistry Laboratories," American Chemical Society Publication, Committee on Safety, 3rd Edition, 1979.
- Provost, L.P., and Elder, R.S. "Interpretation of Percent Recovery Data," *American Laboratory*, 15, 58-63 (1983). (The value 2.44 used in the equation in Section 8.3.3. is two times the value 1.22 derived in this report.)

Environmental Protection Agency

Pt. 136, App. A, Meth. 602

8. "Methods 330.4 (Titrimetric, DPD-FAS) and 330.5 (Spectrophotometric, DPD) for Chlorine, Total Residual," Methods for Chemical Analysis of Water and Wastes, EPA-600/4-79-020, U.S. Environmental Protection Agency, Office of Research and Development, Environmental Monitoring and Support Laboratory, Cincinnati, Ohio 45268, March 1979.

9. "EPA Method Study 25, Method 602, Purgeable Aromatics," EPA 600/4-84-042, National Technical Information Service, PB84-196682, Springfield, Virginia 22161, May 1984.

TABLE 1—CHROMATOGRAPHIC CONDITIONS AND METHOD DETECTION LIMITS—Continued

| Parameter | Retention time (min) | | Method detection limit (µg/L) |
|---------------------------|----------------------|----------|-------------------------------|
| | Column 1 | Column 2 | |
| Toluene | 5.75 | 4.25 | 0.2 |
| Ethylbenzene | 8.25 | 6.25 | 0.2 |
| Chlorobenzene | 9.17 | 8.02 | 0.2 |
| 1,4-Dichlorobenzene | 16.8 | 16.2 | 0.3 |
| 1,3-Dichlorobenzene | 18.2 | 15.0 | 0.4 |
| 1,2-Dichlorobenzene | 25.9 | 19.4 | 0.4 |

Column 1 conditions: Supelcoport (100/120 mesh) coated with 5% SP-1200/1.75% Bentone-34 packed in a 6 ft x 0.085 in. ID stainless steel column with helium carrier gas at 36 mL/min flow rate. Column temperature held at 50 °C for 2 min then programmed at 6 °C/min to 90 °C for a final hold.

Column 2 conditions: Chromosorb W-AW (60/80 mesh) coated with 5% 1,2,3-Tris(2-cyanoethoxy)propane packed in a 6 ft x 0.085 in. ID stainless steel column with helium carrier gas at 30 mL/min flow rate. Column temperature held at 40 °C for 2 min then programmed at 2 °C/min to 100 °C for a final hold.

TABLE 1—CHROMATOGRAPHIC CONDITIONS AND METHOD DETECTION LIMITS

| Parameter | Retention time (min) | | Method detection limit (µg/L) |
|---------------|----------------------|----------|-------------------------------|
| | Column 1 | Column 2 | |
| Benzene | 3.33 | 2.75 | 0.2 |

TABLE 2—CALIBRATION AND QC ACCEPTANCE CRITERIA—METHOD 602 A

| Parameter | Range for Q (µg/L) | Limit for s (µg/L) | Range for \bar{X} (µg/L) | Range for P, P_s (%) |
|---------------------------|--------------------|--------------------|----------------------------|------------------------|
| Benzene | 15.4–24.6 | 4.1 | 10.0–27.9 | 39–150 |
| Chlorobenzene | 16.1–23.9 | 3.5 | 12.7–25.4 | 55–135 |
| 1,2-Dichlorobenzene | 13.6–26.4 | 5.8 | 10.6–27.6 | 37–154 |
| 1,3-Dichlorobenzene | 14.5–25.5 | 5.0 | 12.8–25.5 | 50–141 |
| 1,4-Dichlorobenzene | 13.9–26.1 | 5.5 | 11.6–25.5 | 42–143 |
| Ethylbenzene | 12.6–27.4 | 6.7 | 10.0–28.2 | 32–160 |
| Toluene | 15.5–24.5 | 4.0 | 11.2–27.7 | 46–148 |

Q=Concentration measured in QC check sample, in µg/L (Section 7.5.3).

s=Standard deviation of four recovery measurements, in µg/L (Section 8.2.4).

\bar{X} =Average recovery for four recovery measurements, in µg/L (Section 8.2.4).

P_s, P =Percent recovery measured (Section 8.3.2, Section 8.4.2).

^aCriteria were calculated assuming a QC check sample concentration of 20 µg/L.

Note: These criteria are based directly upon the method performance data in Table 3. Where necessary, the limits for recovery have been broadened to assure applicability of the limits to concentrations below those used to develop Table 3.

TABLE 3—METHOD ACCURACY AND PRECISION AS FUNCTIONS OF CONCENTRATION—METHOD 602

| Parameter | Accuracy, as recovery, X' (µg/L) | Single analyst precision, s' (µg/L) | Overall precision, S' (µg/L) |
|---------------------------|------------------------------------|---------------------------------------|--------------------------------|
| Benzene | 0.92C+0.57 | 0.09 \bar{X} +0.59 | 0.21 \bar{X} +0.56 |
| Chlorobenzene | 0.95C+0.02 | 0.09 \bar{X} +0.23 | 0.17 \bar{X} +0.10 |
| 1,2-Dichlorobenzene | 0.93C+0.52 | 0.17 \bar{X} - 0.04 | 0.22 \bar{X} +0.53 |
| 1,3-Dichlorobenzene | 0.96C - 0.05 | 0.15 \bar{X} - 0.10 | 0.19 \bar{X} +0.09 |
| 1,4-Dichlorobenzene | 0.93C - 0.09 | 0.15 \bar{X} +0.28 | 0.20 \bar{X} +0.41 |
| Ethylbenzene | 0.94C+0.31 | 0.17 \bar{X} +0.46 | 0.26 \bar{X} +0.23 |
| Toluene | 0.94C+0.65 | 0.09 \bar{X} +0.48 | 0.18 \bar{X} +0.71 |

X' =Expected recovery for one or more measurements of a sample containing a concentration of C, in µg/L.

S' =Expected single analyst standard deviation of measurements at an average concentration found of \bar{X} , in X µg/L.

S' =Expected interlaboratory standard deviation of measurements at an average concentration found of \bar{X} , in µg/L.

C=True value for the Concentration, in µg/L.

\bar{X} =Average recovery found for measurements of samples containing a concentration of C, in µg/L.

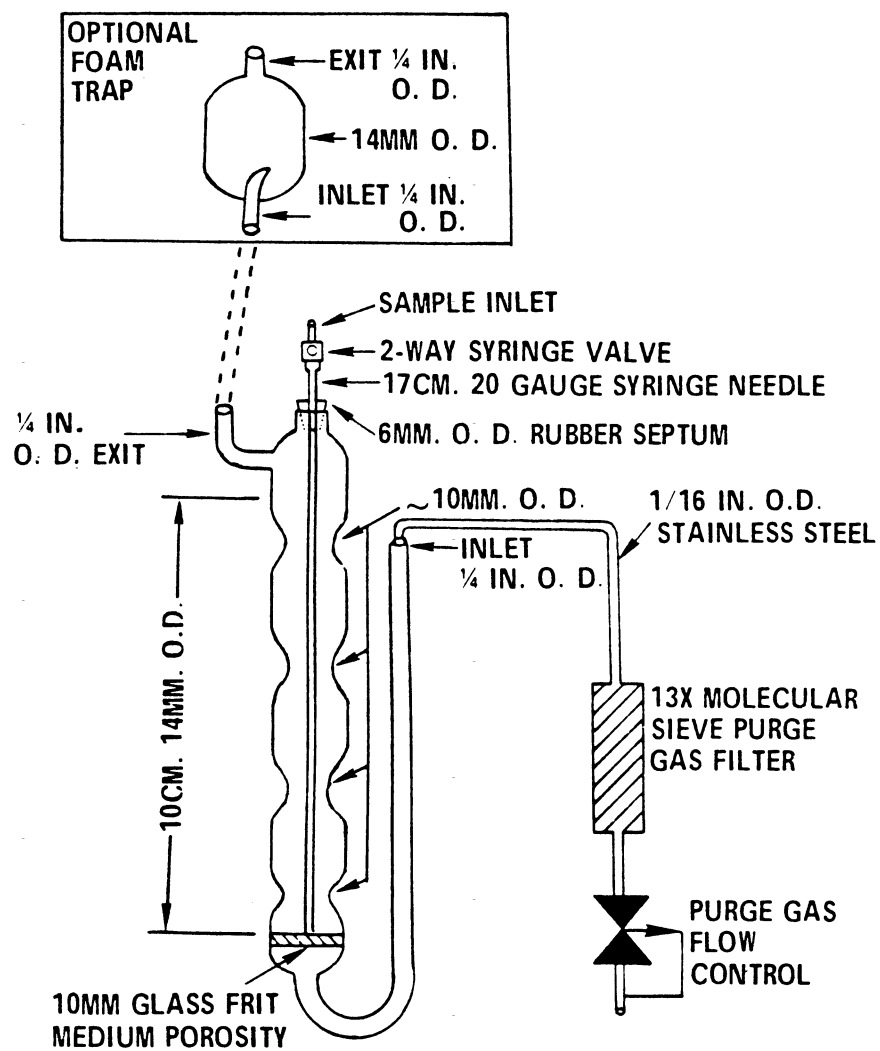

Figure 1. Purging device.

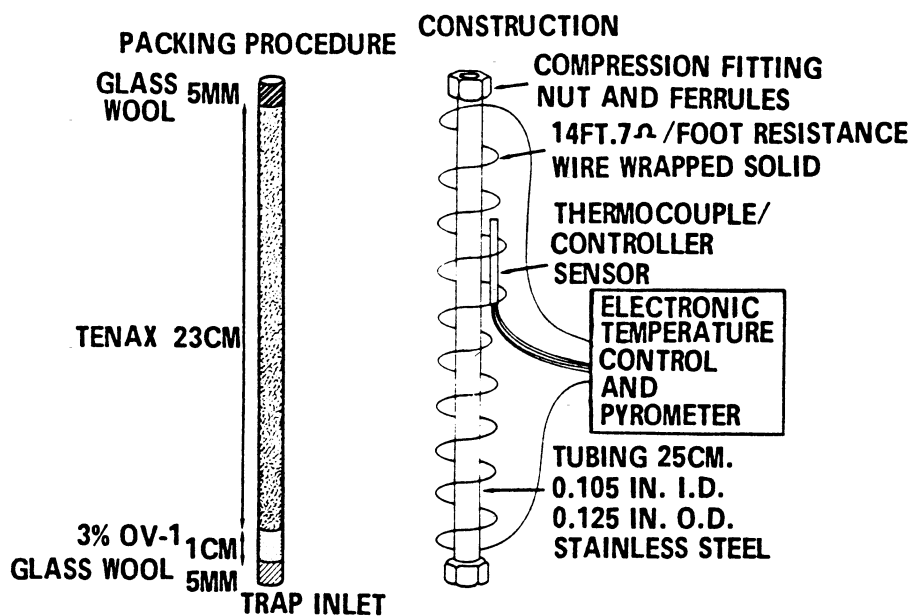

Figure 2. Trap packings and construction to include desorb capability.

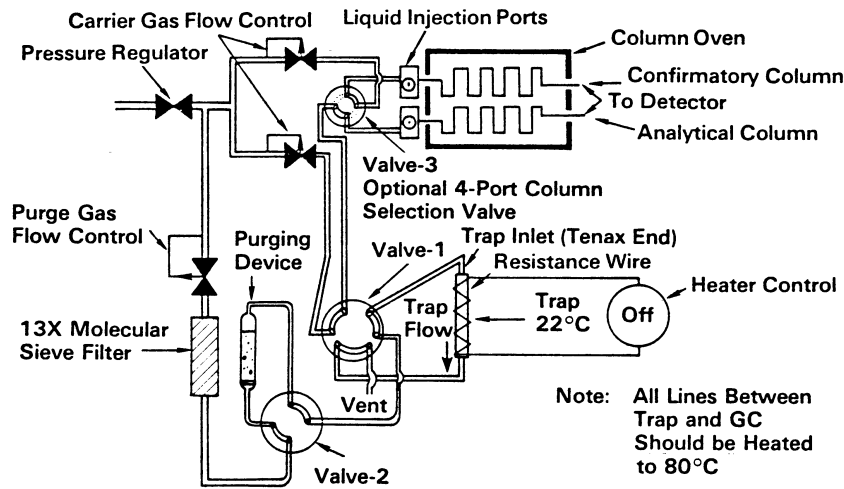

Figure 3. Purge and trap system - purge mode.

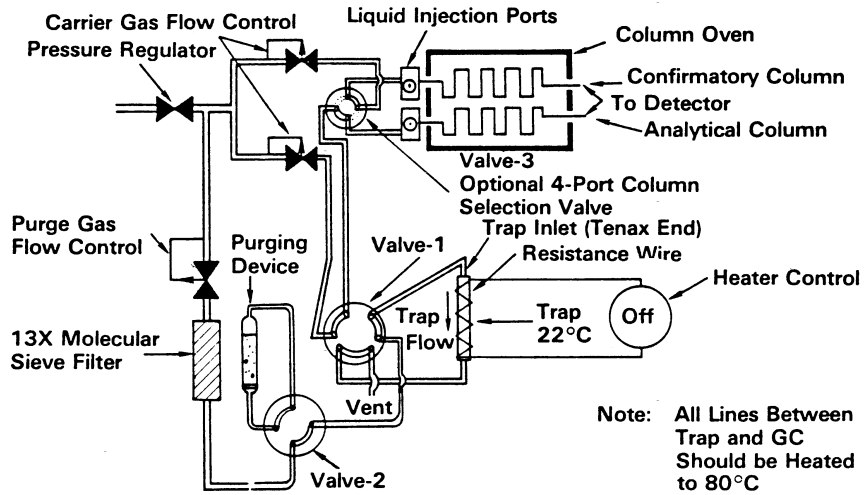

Figure 4. Purge and trap system-dry mode.

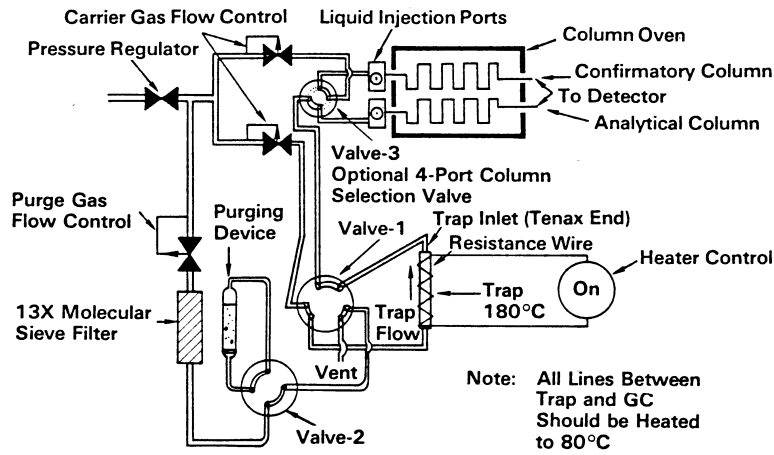

Figure 5. Purge and trap system-desorb mode.

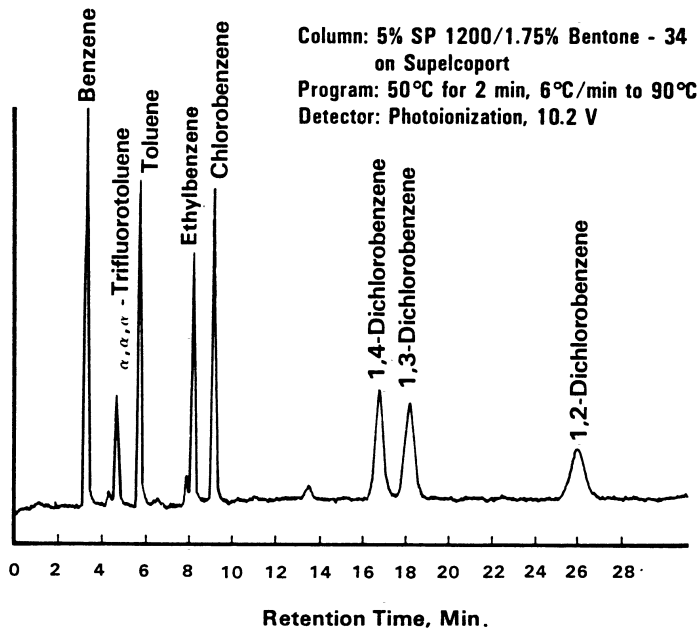

Figure 6. Gas chromatogram of purgeable aromatics.

METHOD 603—ACROLEIN AND ACRYLONITRILE

1. Scope and Application

1.1 This method covers the determination of acrolein and acrylonitrile. The following parameters may be determined by this method:

| Parameter | STORET No. | CAS No. |
|---------------------|------------|----------|
| Acrolein | 34210 | 107-02-8 |
| Acrylonitrile | 34215 | 107-13-1 |

1.2 This is a purge and trap gas chromatographic (GC) method applicable to the determination of the compounds listed above in municipal and industrial discharges as provided under 40 CFR 136.1. When this method is used to analyze unfamiliar samples for either or both of the compounds above, compound identifications should be supported by at least one additional qualitative technique. This method describes analytical conditions for a second gas chromatographic column that can be used to confirm measurements made with the primary column. Method 624 provides gas chromatograph/mass spectrometer (GC/MS) conditions appropriate for the qualitative and quantitative confirmation of results for the parameters listed above, if used with the purge and trap conditions described in this method.

1.3 The method detection limit (MDL, defined in Section 12.1)¹ for each parameter is listed in Table 1. The MDL for a specific wastewater may differ from those listed, depending upon the nature of interferences in the sample matrix.

1.4 Any modification of this method, beyond those expressly permitted, shall be considered as a major modification subject to application and approval of alternate test procedures under 40 CFR 136.4 and 136.5.

1.5 This method is restricted to use by or under the supervision of analysts experienced in the operation of a purge and trap system and a gas chromatograph and in the interpretation of gas chromatograms. Each analyst must demonstrate the ability to generate acceptable results with this method using the procedure described in Section 8.2.

2. Summary of Method

2.1 An inert gas is bubbled through a 5-mL water sample contained in a heated purging chamber. Acrolein and acrylonitrile are transferred from the aqueous phase to the vapor phase. The vapor is swept through a sorbent trap where the analytes are trapped. After the purge is completed, the trap is heated and backflushed with the inert gas to desorb the compound onto a gas chromatographic column. The gas chromatograph is temperature programmed to

separate the analytes which are then detected with a flame ionization detector.^{2,3}

2.2 The method provides an optional gas chromatographic column that may be helpful in resolving the compounds of interest from the interferences that may occur.

3. Interferences

3.1 Impurities in the purge gas and organic compound outgassing from the plumbing of the trap account for the majority of contamination problems. The analytical system must be demonstrated to be free from contamination under the conditions of the analysis by running laboratory reagent blanks as described in Section 8.1.3. The use of non-Teflon plastic tubing, non-Teflon thread sealants, or flow controllers with rubber components in the purge and trap system should be avoided.

3.2 Samples can be contaminated by diffusion of volatile organics through the septum seal into the sample during shipment and storage. A field reagent blank prepared from reagent water and carried through the sampling and handling protocol can serve as a check on such contamination.

3.3 Contamination by carry-over can occur whenever high level and low level samples are sequentially analyzed. To reduce carry-over, the purging device and sample syringe must be rinsed between samples with reagent water. Whenever an unusually concentrated sample is encountered, it should be followed by an analysis of reagent water to check for cross contamination. For samples containing large amounts of water-soluble materials, suspended solids, high boiling compounds or high analyte levels, it may be necessary to wash the purging device with a detergent solution, rinse it with distilled water, and then dry it in an oven at 105°C between analyses. The trap and other parts of the system are also subject to contamination, therefore, frequent bakeout and purging of the entire system may be required.

4. Safety

4.1 The toxicity or carcinogenicity of each reagent used in this method has not been precisely defined; however, each chemical compound should be treated as a potential health hazard. From this view point, exposure to these chemicals must be reduced to the lowest possible level by whatever means available. The laboratory is responsible for maintaining a current awareness file of OSHA regulations regarding the safe handling of the chemicals specified in this method. A reference file of material data handling sheets should also be made available to all personnel involved in the chemical analysis. Additional references to laboratory safety are available and have been identified^{4,6} for the information of the analyst.

5. Apparatus and Materials

5.1 Sampling equipment, for discrete sampling.

5.1.1 Vial—25-mL capacity or larger, equipped with a screw cap with a hole in the center (Pierce #13075 or equivalent). Detergent wash, rinse with tap and distilled water, and dry at 105 °C before use.

5.1.2 Septum—Teflon-faced silicone (Pierce #12722 or equivalent). Detergent wash, rinse with tap and distilled water and dry at 105 °C for 1 h before use.

5.2 Purge and trap system—The purge and trap system consists of three separate pieces of equipment: a purging device, trap, and desorber. Several complete systems are now commercially available.

5.2.1 The purging device must be designed to accept 5-mL samples with a water column at least 3 cm deep. The gaseous head space between the water column and the trap must have a total volume of less than 15 mL. The purge gas must pass through the water column as finely divided bubbles with a diameter of less than 3 mm at the origin. The purge gas must be introduced no more than 5 mm from the base of the water column. The purging device must be capable of being heated to 85 °C within 3.0 min after transfer of the sample to the purging device and being held at 85 ± 2 °C during the purge cycle. The entire water column in the purging device must be heated. Design of this modification to the standard purging device is optional, however, use of a water bath is suggested.

5.2.1.1 Heating mantle—To be used to heat water bath.

5.2.1.2 Temperature controller—Equipped with thermocouple/sensor to accurately control water bath temperature to ± 2 °C. The purging device illustrated in Figure 1 meets these design criteria.

5.2.2 The trap must be at least 25 cm long and have an inside diameter of at least 0.105 in. The trap must be packed to contain 1.0 cm of methyl silicone coated packing (Section 6.5.2) and 23 cm of 2,6-diphenylene oxide polymer (Section 6.5.1). The minimum specifications for the trap are illustrated in Figure 2.

5.2.3 The desorber must be capable of rapidly heating the trap to 180 °C. The desorber illustrated in Figure 2 meets these design criteria.

5.2.4 The purge and trap system may be assembled as a separate unit as illustrated in Figure 3 or be coupled to a gas chromatograph.

5.3 pH paper—Narrow pH range, about 3.5 to 5.5 (Fisher Scientific Short Range Alkacid No. 2, #14-837-2 or equivalent).

5.4 Gas chromatograph—An analytical system complete with a temperature programmable gas chromatograph suitable for on-column injection and all required acces-

sories including syringes, analytical columns, gases, detector, and strip-chart recorder. A data system is recommended for measuring peak areas.

5.4.1 Column 1—10 ft long × 2 mm ID glass or stainless steel, packed with Porapak-QS (80/100 mesh) or equivalent. This column was used to develop the method performance statements in Section 12. Guidelines for the use of alternate column packings are provided in Section 10.1.

5.4.2 Column 2—6 ft long × 0.1 in. ID glass or stainless steel, packed with Chromosorb 101 (60/80 mesh) or equivalent.

5.4.3 Detector—Flame ionization detector. This type of detector has proven effective in the analysis of wastewaters for the parameters listed in the scope (Section 1.1), and was used to develop the method performance statements in Section 12. Guidelines for the use of alternate detectors are provided in Section 10.1.

5.5 Syringes—5-mL, glass hypodermic with Luerlok tip (two each).

5.6 Micro syringes—25-μL, 0.006 in. ID needle.

5.7 Syringe valve—2-way, with Luer ends (three each).

5.8 Bottle—15-mL, screw-cap, with Teflon cap liner.

5.9 Balance—Analytical, capable of accurately weighing 0.0001 g.

6. Reagents

6.1 Reagent water—Reagent water is defined as a water in which an interferent is not observed at the MDL of the parameters of interest.

6.1.1 Reagent water can be generated by passing tap water through a carbon filter bed containing about 1 lb of activated carbon (Filtrisorb-300, Calgon Corp., or equivalent).

6.1.2 A water purification system (Millipore Super-Q or equivalent) may be used to generate reagent water.

6.1.3 Reagent water may also be prepared by boiling water for 15 min. Subsequently, while maintaining the temperature at 90 °C, bubble a contaminant-free inert gas through the water for 1 h. While still hot, transfer the water to a narrow mouth screw-cap bottle and seal with a Teflon-lined septum and cap.

6.2 Sodium thiosulfate—(ACS) Granular.

6.3 Sodium hydroxide solution (10 N)—Dissolve 40 g of NaOH (ACS) in reagent water and dilute to 100 mL.

6.4 Hydrochloric acid (1+1)—Slowly, add 50 mL of concentrated HCl (ACS) to 50 mL of reagent water.

6.5 Trap Materials:

6.5.1 2,6-Diphenylene oxide polymer—Tenax (60/80 mesh), chromatographic grade or equivalent.

6.5.2 Methyl silicone packing—3% OV-1 on Chromosorb-W (60/80 mesh) or equivalent.

6.6 Stock standard solutions—Stock standard solutions may be prepared from pure standard materials or purchased as certified solutions. Prepare stock standard solutions in reagent water using assayed liquids. Since acrolein and acrylonitrile are lachrymators, primary dilutions of these compounds should be prepared in a hood. A NIOSH/MESA approved toxic gas respirator should be used when the analyst handles high concentrations of such materials.

6.6.1 Place about 9.8 mL of reagent water into a 10-mL ground glass stoppered volumetric flask. For acrolein standards the reagent water must be adjusted to pH 4 to 5. Weight the flask to the nearest 0.1 mg.

6.6.2 Using a 100- μ L syringe, immediately add two or more drops of assayed reference material to the flask, then reweigh. Be sure that the drops fall directly into the water without contacting the neck of the flask.

6.6.3 Reweigh, dilute to volume, stopper, then mix by inverting the flask several times. Calculate the concentration in μ g/ μ L from the net gain in weight. When compound purity is assayed to be 96% or greater, the weight can be used without correction to calculate the concentration of the stock standard. Optionally, stock standard solutions may be prepared using the pure standard material by volumetrically measuring the appropriate amounts and determining the weight of the material using the density of the material. Commercially prepared stock standards may be used at any concentration if they are certified by the manufacturer or by an independent source.

6.6.4 Transfer the stock standard solution into a Teflon-sealed screw-cap bottle. Store at 4 °C and protect from light.

6.6.5 Prepare fresh standards daily.

6.7 Secondary dilution standards—Using stock standard solutions, prepare secondary dilution standards in reagent water that contain the compounds of interest, either singly or mixed together. The secondary dilution standards should be prepared at concentrations such that the aqueous calibration standards prepared in Section 7.3.1 or 7.4.1 will bracket the working range of the analytical system. Secondary dilution standards should be prepared daily and stored at 4 °C.

6.8 Quality control check sample concentration—See Section 8.2.1.

7. Calibration

7.1 Assemble a purge and trap system that meets the specifications in Section 5.2. Condition the trap overnight at 180 °C by backflushing with an inert gas flow of at least 20 mL/min. Condition the trap for 10 min once daily prior to use.

7.2 Connect the purge and trap system to a gas chromatograph. The gas chromatograph must be operated using temperature and flow rate conditions equivalent to those given in Table 1. Calibrate the purge

and trap-gas chromatographic system using either the external standard technique (Section 7.3) or the internal standard technique (Section 7.4).

7.3 External standard calibration procedure:

7.3.1 Prepare calibration standards at a minimum of three concentration levels for each parameter by carefully adding 20.0 μ L of one or more secondary dilution standards to 100, 500, or 1000 mL of reagent water. A 25- μ L syringe with a 0.006 in. ID needle should be used for this operation. One of the external standards should be at a concentration near, but above, the MDL and the other concentrations should correspond to the expected range of concentrations found in real samples or should define the working range of the detector. These standards must be prepared fresh daily.

7.3.2 Analyze each calibration standard according to Section 10, and tabulate peak height or area responses versus the concentration of the standard. The results can be used to prepare a calibration curve for each compound. Alternatively, if the ratio of response to concentration (calibration factor) is a constant over the working range (< 10% relative standard deviation, RSD), linearity through the origin can be assumed and the average ratio or calibration factor can be used in place of a calibration curve.

7.4 Internal standard calibration procedure—To use this approach, the analyst must select one or more internal standards that are similar in analytical behavior to the compounds of interest. The analyst must further demonstrate that the measurement of the internal standard is not affected by method or matrix interferences. Because of these limitations, no internal standard can be suggested that is applicable to all samples.

7.4.1 Prepare calibration standards at a minimum of three concentration levels for each parameter of interest as described in Section 7.3.1.

7.4.2 Prepare a spiking solution containing each of the internal standards using the procedures described in Sections 6.6 and 6.7. It is recommended that the secondary dilution standard be prepared at a concentration of 15 μ g/mL of each internal standard compound. The addition of 10 μ L of this standard to 5.0 mL of sample or calibration standard would be equivalent to 30 μ g/L.

7.4.3 Analyze each calibration standard according to Section 10, adding 10 μ L of internal standard spiking solution directly to the syringe (Section 10.4). Tabulate peak height or area responses against concentration for each compound and internal standard, and calculate response factors (RF) for each compound using Equation 1.

$$RF = (A_s)(C_{is}) / (A_{is})(C_s)$$

Equation 1

where:

A_s = Response for the parameter to be measured.

A_{is} = Response for the internal standard.

C_{is} = Concentration of the internal standard.

C_s = Concentration of the parameter to be measured.

If the RF value over the working range is a constant (<10% RSD), the RF can be assumed to be invariant and the average RF can be used for calculations. Alternatively, the results can be used to plot a calibration curve of response ratios, A_s/A_{is} , vs. RF.

7.5 The working calibration curve, calibration factor, or RF must be verified on each working day by the measurement of a QC check sample.

7.5.1 Prepare the QC check sample as described in Section 8.2.2.

7.5.2 Analyze the QC check sample according to Section 10.

7.5.3 For each parameter, compare the response (Q) with the corresponding calibration acceptance criteria found in Table 2. If the responses for all parameters of interest fall within the designated ranges, analysis of actual samples can begin. If any individual Q falls outside the range, a new calibration curve, calibration factor, or RF must be prepared for that parameter according to Section 7.3 or 7.4.

8. Quality Control

8.1 Each laboratory that uses this method is required to operate a formal quality control program. The minimum requirements of this program consist of an initial demonstration of laboratory capability and an ongoing analysis of spiked samples to evaluate and document data quality. The laboratory must maintain records to document the quality of data that is generated. Ongoing data quality checks are compared with established performance criteria to determine if the results of analyses meet the performance characteristics of the method. When results of sample spikes indicate atypical method performance, a quality control check standard must be analyzed to confirm that the measurements were performed in an in-control mode of operation.

8.1.1 The analyst must make an initial, one-time, demonstration of the ability to generate acceptable accuracy and precision with this method. This ability is established as described in Section 8.2.

8.1.2 In recognition of advances that are occurring in chromatography, the analyst is permitted certain options (detailed in Section 10.1) to improve the separations or lower the cost of measurements. Each time such a modification is made to the method, the analyst is required to repeat the procedure in Section 8.2.

8.1.3 Each day, the analyst must analyze a reagent water blank to demonstrate that

interferences from the analytical system are under control.

8.1.4 The laboratory must, on an ongoing basis, spike and analyze a minimum of 10% of all samples to monitor and evaluate laboratory data quality. This procedure is described in Section 8.3.

8.1.5 The laboratory must, on an ongoing basis, demonstrate through the analyses of quality control check standards that the operation of the measurement system is in control. This procedure is described in Section 8.4. The frequency of the check standard analyses is equivalent to 10% of all samples analyzed but may be reduced if spike recoveries from samples (Section 8.3) meet all specified quality control criteria.

8.1.6 The laboratory must maintain performance records to document the quality of data that is generated. This procedure is described in Section 8.5.

8.2 To establish the ability to generate acceptable accuracy and precision, the analyst must perform the following operations.

8.2.1 A quality control (QC) check sample concentrate is required containing each parameter of interest at a concentration of 25 µg/mL in reagent water. The QC check sample concentrate must be obtained from the U.S. Environmental Protection Agency, Environmental Monitoring and Support Laboratory in Cincinnati, Ohio, if available. If not available from that source, the QC check sample concentrate must be obtained from another external source. If not available from either source above, the QC check sample concentrate must be prepared by the laboratory using stock standards prepared independently from those used for calibration.

8.2.2 Prepare a QC check sample to contain 50 µg/L of each parameter by adding 200 µL of QC check sample concentrate to 100 mL of reagent water.

8.2.3 Analyze four 5-mL aliquots of the well-mixed QC check sample according to Section 10.

8.2.4 Calculate the average recovery (\bar{X}) in µg/L, and the standard deviation of the recovery (s) in µg/L, for each parameter using the four results.

8.2.5 For each parameter compare s and \bar{X} with the corresponding acceptance criteria for precision and accuracy, respectively, found in Table 3. If s and \bar{X} for all parameters of interest meet the acceptance criteria, the system performance is acceptable and analysis of actual samples can begin. If either s exceeds the precision limit or \bar{X} falls outside the range for accuracy, the system performance is unacceptable for that parameter. Locate and correct the source of the problem and repeat the test for each compound of interest.

8.3 The laboratory must, on an ongoing basis, spike at least 10% of the samples from each sample site being monitored to assess accuracy. For laboratories analyzing one to

ten samples per month, at least one spiked sample per month is required.

8.3.1 The concentration of the spike in the sample should be determined as follows:

8.3.1.1 If, as in compliance monitoring, the concentration of a specific parameter in the sample is being checked against a regulatory concentration limit, the spike should be at that limit or 1 to 5 times higher than the background concentration determined in Section 8.3.2, whichever concentration would be larger.

8.3.1.2 If the concentration of a specific parameter in the sample is not being checked against a limit specific to that parameter, the spike should be at 50 µg/L or 1 to 5 times higher than the background concentration determined in Section 8.3.2, whichever concentration would be larger.

8.3.2 Analyze one 5-mL sample aliquot to determine the background concentration (B) of each parameter. If necessary, prepare a new QC check sample concentrate (Section 8.2.1) appropriate for the background concentrations in the sample. Spike a second 5-mL sample aliquot with 10 µL of the QC check sample concentrate and analyze it to determine the concentration after spiking (A) of each parameter. Calculate each percent recovery (P) as $100(A - B)/T$, where T is the known true value of the spike.

8.3.3 Compare the percent recovery (P) for each parameter with the corresponding QC acceptance criteria found in Table 3. These acceptance criteria were calculated to include an allowance for error in measurement of both the background and spike concentrations, assuming a spike to background ratio of 5:1. This error will be accounted for to the extent that the analyst's spike to background ratio approaches 5:1.⁷

8.3.4 If any individual P falls outside the designated range for recovery, that parameter has failed the acceptance criteria. A check standard containing each parameter that failed the criteria must be analyzed as described in Section 8.4.

8.4 If any parameter fails the acceptance criteria for recovery in Section 8.3, a QC check standard containing each parameter that failed must be prepared and analyzed.

NOTE: The frequency for the required analysis of a QC check standard will depend upon the number of parameters being simultaneously tested, the complexity of the sample matrix, and the performance of the laboratory.

8.4.1 Prepare the QC check standard by adding 10 µL of QC check sample concentrate (Section 8.2.1 or 8.3.2) to 5 mL of reagent water. The QC check standard needs only to contain the parameters that failed criteria in the test in Section 8.3.

8.4.2 Analyze the QC check standard to determine the concentration measured (A) of each parameter. Calculate each percent re-

covery (P_s) as $100(A/T)\%$, where T is the true value of the standard concentration.

8.4.3 Compare the percent recovery (P_s) for each parameter with the corresponding QC acceptance criteria found in Table 3. Only parameters that failed the test in Section 8.3 need to be compared with these criteria. If the recovery of any such parameter falls outside the designated range, the laboratory performance for that parameter is judged to be out of control, and the problem must be immediately identified and corrected. The analytical result for that parameter in the unspiked sample is suspect and may not be reported for regulatory compliance purposes.

8.5 As part of the QC program for the laboratory, method accuracy for wastewater samples must be assessed and records must be maintained. After the analysis of five spiked wastewater samples as in Section 8.3, calculate the average percent recovery (P) and the standard deviation of the percent recovery (s_p). Express the accuracy assessment as a percent recovery interval from $P - 2s_p$ to $P + 2s_p$. If P=90% and s_p=10%, for example, the accuracy interval is expressed as 70-110%. Update the accuracy assessment for each parameter on a regular basis (e.g. after each five to ten new accuracy measurements).

8.6 It is recommended that the laboratory adopt additional quality assurance practices for use with this method. The specific practices that are most productive depend upon the needs of the laboratory and the nature of the samples. Field duplicates may be analyzed to assess the precision of the environmental measurements. When doubt exists over the identification of a peak on the chromatogram, confirmatory techniques such as gas chromatography with a dissimilar column or mass spectrometer must be used. Whenever possible, the laboratory should analyze standard reference materials and participate in relevant performance evaluation studies.

9. Sample Collection, Preservation, and Handling

9.1 All samples must be iced or refrigerated from the time of collection until analysis. If the sample contains free or combined chlorine, add sodium thiosulfate preservative (10 mg/40 mL is sufficient for up to 5 ppm Cl₂) to the empty sample bottle just prior to shipping to the sampling site. EPA Methods 330.4 and 330.5 may be used for measurement of residual chlorine.⁸ Field test kits are available for this purpose.

9.2 If acrolein is to be analyzed, collect about 500 mL of sample in a clean glass container. Adjust the pH of the sample to 4 to 5 using acid or base, measuring with narrow range pH paper. Samples for acrolein analysis receiving no pH adjustment must be analyzed within 3 days of sampling.

9.3 Grab samples must be collected in glass containers having a total volume of at

least 25 mL. Fill the sample bottle just to overflowing in such a manner that no air bubbles pass through the sample as the bottle is being filled. Seal the bottle so that no air bubbles are entrapped in it. If preservative has been added, shake vigorously for 1 min. Maintain the hermetic seal on the sample bottle until time of analysis.

9.4 All samples must be analyzed within 14 days of collection.³

10. Procedure

10.1 Table 1 summarizes the recommended operating conditions for the gas chromatograph. Included in this table are estimated retention times and MDL that can be achieved under these conditions. An example of the separations achieved by Column 1 is shown in Figure 5. Other packed columns, chromatographic conditions, or detectors may be used if the requirements of Section 8.2 are met.

10.2 Calibrate the system daily as described in Section 7.

10.3 Adjust the purge gas (nitrogen or helium) flow rate to 20 mL-min. Attach the trap inlet to the purging device, and set the purge and trap system to purge (Figure 3). Open the syringe valve located on the purging device sample introduction needle.

10.4 Remove the plunger from a 5-mL syringe and attach a closed syringe valve. Open the sample bottle (or standard) and carefully pour the sample into the syringe barrel to just short of overflowing. Replace the syringe plunger and compress the sample. Open the syringe valve and vent any residual air while adjusting the sample volume to 5.0 mL. Since this process of taking an aliquot destroys the validity of the sample for future analysis, the analyst should fill a second syringe at this time to protect against possible loss of data. Add 10.0 µL of the internal standard spiking solution (Section 7.4.2), if applicable, through the valve bore then close the valve.

10.5 Attach the syringe-syringe valve assembly to the syringe valve on the purging device. Open the syringe valves and inject the sample into the purging chamber.

10.6 Close both valves and purge the sample for 15.0 ± 0.1 min while heating at 85 ± 2 °C.

10.7 After the 15-min purge time, attach the trap to the chromatograph, adjust the purge and trap system to the desorb mode (Figure 4), and begin to temperature program the gas chromatograph. Introduce the trapped materials to the GC column by rapidly heating the trap to 180 °C while backflushing the trap with an inert gas between 20 and 60 mL/min for 1.5 min.

10.8 While the trap is being desorbed into the gas chromatograph, empty the purging chamber using the sample introduction syringe. Wash the chamber with two 5-mL flushes of reagent water.

10.9 After desorbing the sample for 1.5 min, recondition the trap by returning the purge and trap system to the purge mode. Wait 15 s then close the syringe valve on the purging device to begin gas flow through the trap. The trap temperature should be maintained at 210 °C. After approximately 7 min, turn off the trap heater and open the syringe valve to stop the gas flow through the trap. When the trap is cool, the next sample can be analyzed.

10.10 Identify the parameters in the sample by comparing the retention times of the peaks in the sample chromatogram with those of the peaks in standard chromatograms. The width of the retention time window used to make identifications should be based upon measurements of actual retention time variations of standards over the course of a day. Three times the standard deviation of a retention time for a compound can be used to calculate a suggested window size; however, the experience of the analyst should weigh heavily in the interpretation of chromatograms.

11. Calculations

11.1 Determine the concentration of individual compounds in the sample.

11.1.1 If the external standard calibration procedure is used, calculate the concentration of the parameter being measured from the peak response using the calibration curve or calibration factor determined in Section 7.3.2.

11.1.2 If the internal standard calibration procedure is used, calculate the concentration in the sample using the response factor (RF) determined in Section 7.4.3 and Equation 2.

$$\text{Concentration } (\mu\text{g/L}) = \frac{(A_s)(C_{is})}{(A_{is})(\text{RF})}$$

Equation 2

where:

A_s=Response for the parameter to be measured.

A_{is}=Response for the internal standard.

C_{is}=Concentration of the internal standard.

11.2 Report results in µg/L without correction for recovery data. All QC data obtained should be reported with the sample results.

12. Method Performance

12.1 The method detection limit (MDL) is defined as the minimum concentration of a substance that can be measured and reported with 99% confidence that the value is above zero.¹ The MDL concentrations listed in Table 1 were obtained using reagent water.⁹ The MDL actually achieved in a given analysis will vary depending on instrument sensitivity and matrix effects.

12.2 This method is recommended for the concentration range from the MDL to 1,000xMDL. Direct aqueous injection techniques should be used to measure concentration levels above 1,000xMDL.

12.3 In a single laboratory (Battelle-Columbus), the average recoveries and standard deviations presented in Table 2 were obtained.⁹ Seven replicate samples were analyzed at each spike level.

References

- 40 CFR part 136, appendix B.
- Bellar, T.A., and Lichtenberg, J.J. "Determining Volatile Organics at Microgram-per-Litre-Levels by Gas Chromatography," *Journal American Water Works Association*, 66, 739 (1974).
- "Evaluate Test Procedures for Acrolein and Acrylonitrile," Special letter report for EPA Project 4719-A, U.S. Environmental Protection Agency, Environmental Monitoring and Support Laboratory, Cincinnati, Ohio 45268, 27 June 1979.
- "Carcinogens—Working With Carcinogens," Department of Health, Education, and Welfare, Public Health Service, Center for Disease Control, National Institute for Occupational Safety and Health, Publication No. 77-206, August 1977.
- "OSHA Safety and Health Standards, General Industry," (29 CFR part 1910), Occupational Safety and Health Administration, OSHA 2206 (Revised, January 1976).
- "Safety in Academic Chemistry Laboratories," American Chemical Society Publication, Committee on Chemical Safety, 3rd Edition, 1979.

7. Provost, L.P., and Elder, R.S. "Interpretation of Percent Recovery Data," *American Laboratory*, 15, 58-63 (1983).

8. "Methods 330.4 (Titrimetric, DPD-FAS) and 330.5 (Spectrophotometric, DPD) for Chlorine, Total Residual," Methods for Chemical Analysis of Water and Wastes, EPA-600/4-79-020, U.S. Environmental Protection Agency, Environmental Monitoring and Support Laboratory, Cincinnati, Ohio 45268, March 1979.

9. "Evaluation of Method 603 (Modified)," EPA-600/4-84-ABC, National Technical Information Service, PB84-, Springfield, Virginia 22161, Nov. 1984.

TABLE 1—CHROMATOGRAPHIC CONDITIONS AND METHOD DETECTION LIMITS

| Parameter | Retention time (min) | | Method detection limit (µg/L) |
|---------------------|----------------------|----------|-------------------------------|
| | Column 1 | Column 2 | |
| Acrolein | 10.6 | 8.2 | 0.7 |
| Acrylonitrile | 12.7 | 9.8 | 0.5 |

Column 1 conditions: Porapak-QS (80/100 mesh) packed in a 10 ft x 2 mm ID glass or stainless steel column with helium carrier gas at 30 mL/min flow rate. Column temperature held isothermal at 110 °C for 1.5 min (during desorption), then heated as rapidly as possible to 150 °C and held for 20 min; column bakeout at 190 °C for 10 min.⁹

Column 2 conditions: Chromosorb 101 (60/80 mesh) packed in a 6 ft. x 0.1 in. ID glass or stainless steel column with helium carrier gas at 40 mL/min flow rate. Column temperature held isothermal at 80 °C for 4 min, then programmed at 50 °C/min to 120 °C and held for 12 min.

TABLE 2—SINGLE LABORATORY ACCURACY AND PRECISION—METHOD 603

| Parameter | Sample matrix | Spike conc. (µg/L) | Average recovery (µg/L) | Standard deviation (µg/L) | Average percent recovery |
|---------------------|---------------|--------------------|-------------------------|---------------------------|--------------------------|
| Acrolein | RW | 5.0 | 5.2 | 0.2 | 104 |
| | RW | 50.0 | 51.4 | 0.7 | 103 |
| | POTW | 5.0 | 4.0 | 0.2 | 80 |
| | POTW | 50.0 | 44.4 | 0.8 | 89 |
| | IW | 5.0 | 0.1 | 0.1 | 2 |
| | IW | 100.0 | 9.3 | 1.1 | 9 |
| Acrylonitrile | RW | 5.0 | 4.2 | 0.2 | 84 |
| | RW | 50.0 | 51.4 | 1.5 | 103 |
| | POTW | 20.0 | 20.1 | 0.8 | 100 |
| | POTW | 100.0 | 101.3 | 1.5 | 101 |
| | IW | 10.0 | 9.1 | 0.8 | 91 |
| | IW | 100.0 | 104.0 | 3.2 | 104 |

ARW=Reagent water.
 APOTW=Prechlorination secondary effluent from a municipal sewage treatment plant.
 AIW=Industrial wastewater containing an unidentified acrolein reactant.

TABLE 3—CALIBRATION AND QC ACCEPTANCE CRITERIA—METHOD 603^A

| Parameter | Range for Q (µg/L) | Limit for S (µg/L) | Range for X (µg/L) | Range for P, P _s (%) |
|---------------------|--------------------|--------------------|--------------------|---------------------------------|
| Acrolein | 45.9–54.1 | 4.6 | 42.9–60.1 | 88–118 |
| Acrylonitrile | 41.2–58.8 | 9.9 | 33.1–69.9 | 71–135 |

^A=Criteria were calculated assuming a QC check sample concentration of 50 µg/L.⁹
 Q=Concentration measured in QC check sample, in µg/L (Section 7.5.3).

s=Standard deviation of four recovery measurements, in $\mu\text{g/L}$ (Section 8.2.4).
 X=Average recovery for four recovery measurements, in $\mu\text{g/L}$ (Section 8.2.4).
 P, P_i=Percent recovery measured (Section 8.3.2, Section 8.4.2).

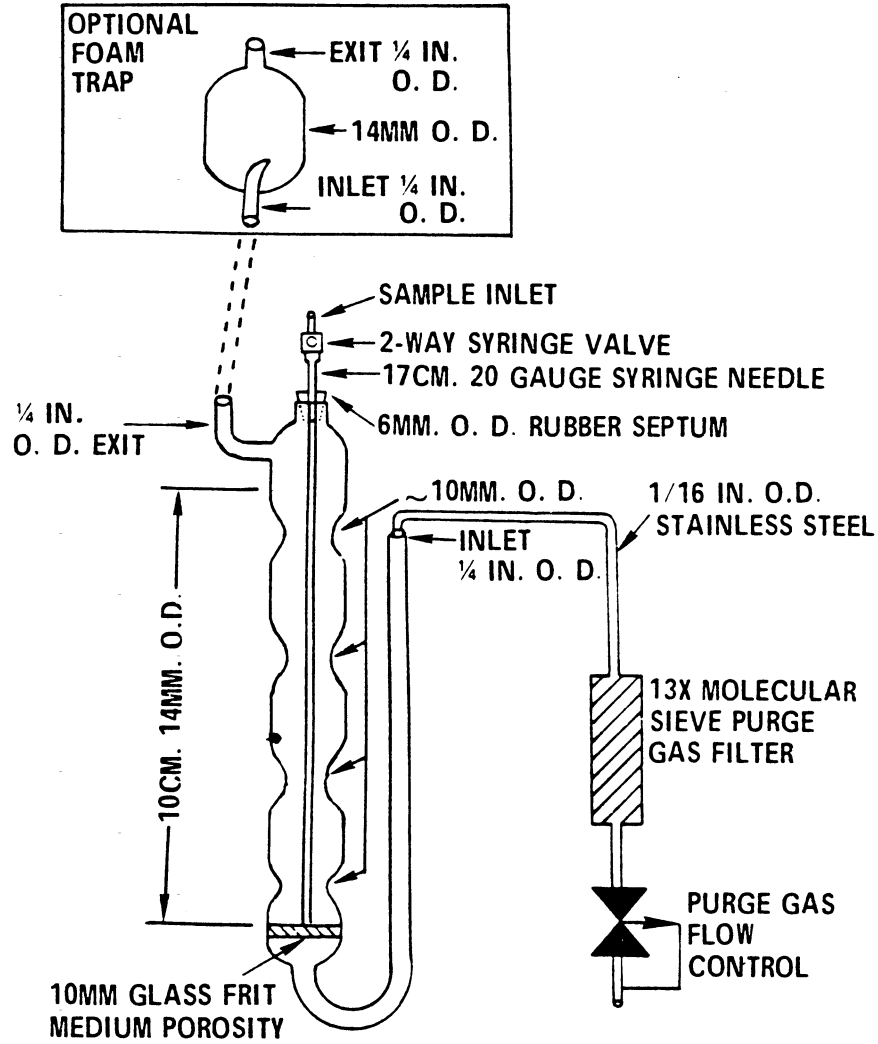

Figure 1. Purging device.

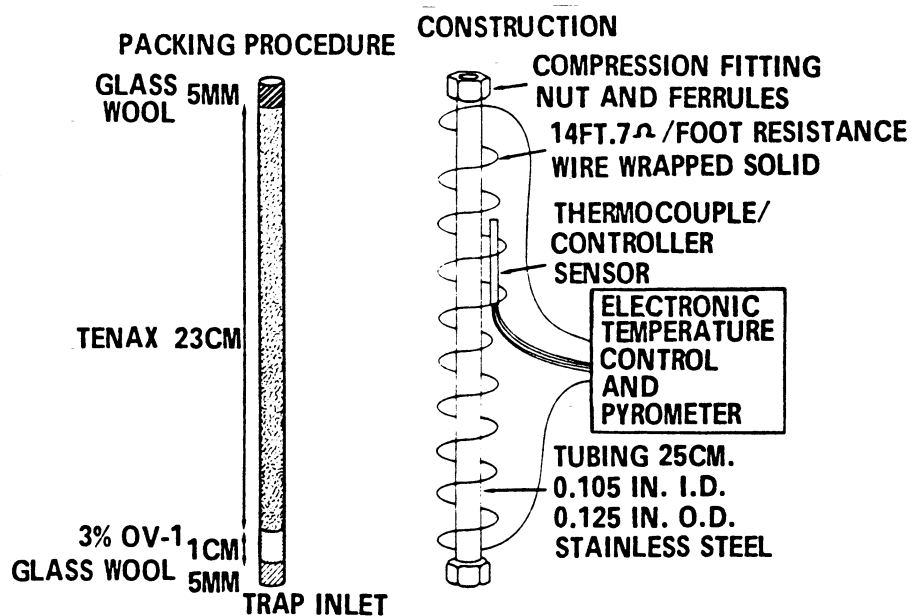

Figure 2. Trap packings and construction to include desorb capability.

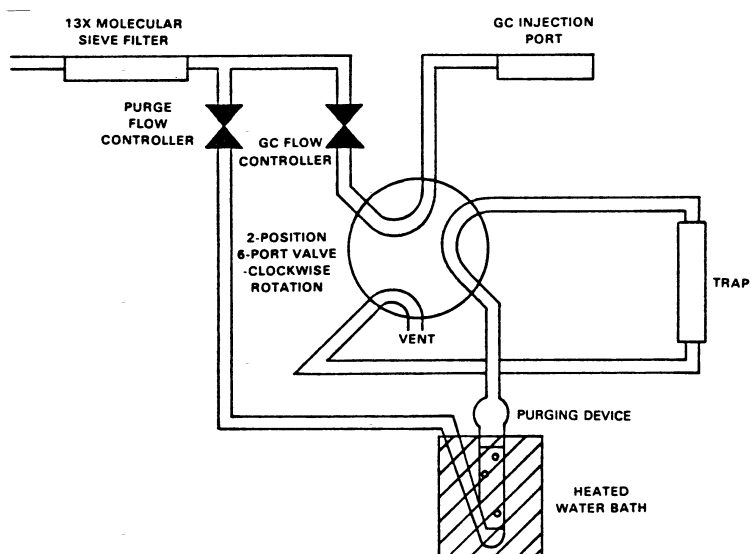

Figure 3. Purge and trap system-purge mode.

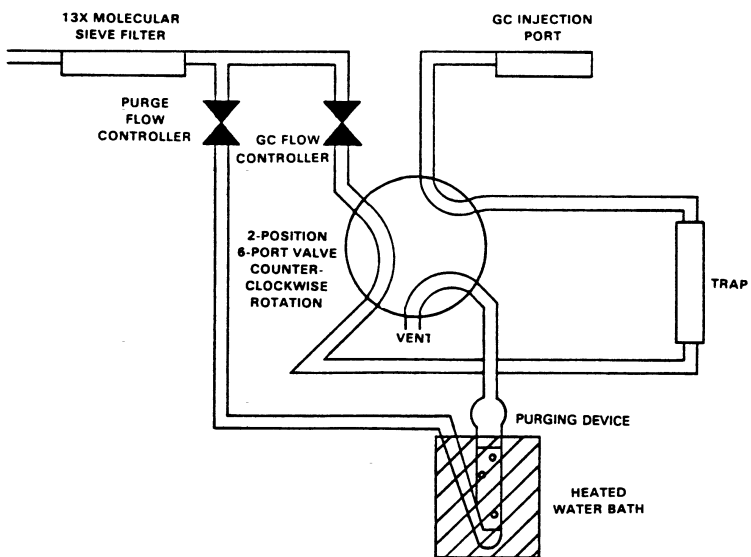

Figure 4. Purge and trap system-desorb mode.

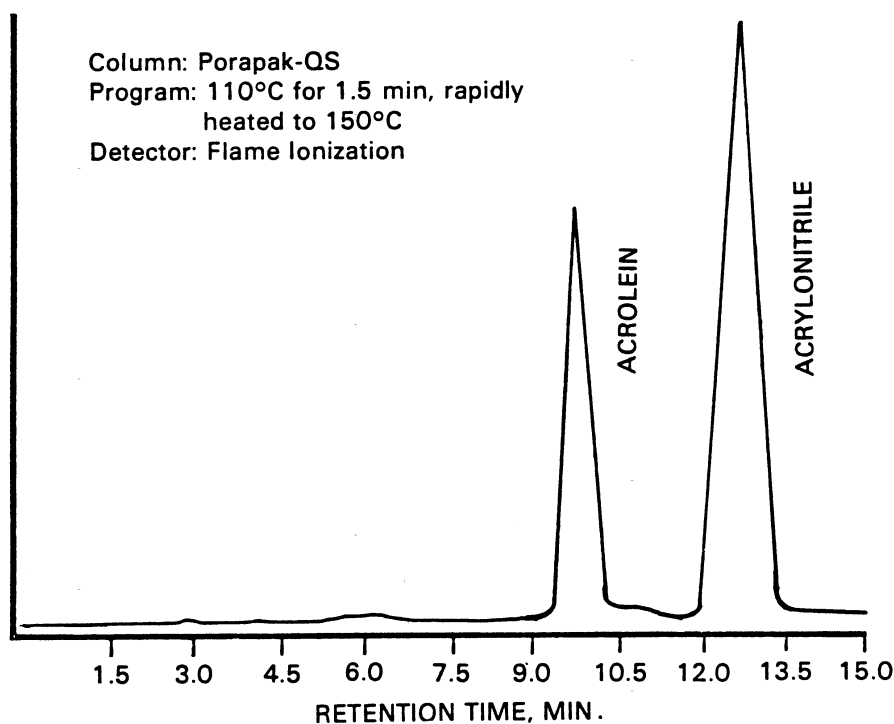

Figure 5. Gas chromatogram of acrolein and acrylonitrile.

METHOD 604—PHENOLS

1. Scope and Application

1.1 This method covers the determination of phenol and certain substituted phenols. The following parameters may be determined by this method:

| Parameter | STORET No. | CAS No. |
|----------------------------------|------------|----------|
| 4-Chloro-3-methylphenol | 34452 | 59-50-7 |
| 2-Chlorophenol | 34586 | 95-57-8 |
| 2,4-Dichlorophenol | 34601 | 120-83-2 |
| 2,4-Dimethylphenol | 34606 | 105-67-9 |
| 2,4-Dinitrophenol | 34616 | 51-28-5 |
| 2-Methyl-4,6-dinitrophenol | 34657 | 534-52-1 |
| 2-Nitrophenol | 34591 | 88-75-5 |
| 4-Nitrophenol | 34646 | 100-02-7 |
| Pentachlorophenol | 39032 | 87-86-5 |
| Phenol | 34694 | 108-95-2 |
| 2,4,6-Trichlorophenol | 34621 | 88-06-2 |

1.2 This is a flame ionization detector gas chromatographic (FIDGC) method applicable to the determination of the compounds listed above in municipal and industrial discharges as provided under 40 CFR 136.1. When this

method is used to analyze unfamiliar samples for any or all of the compounds above, compound identifications should be supported by at least one additional qualitative technique. This method describes analytical conditions for derivatization, cleanup, and electron capture detector gas chromatography (ECDGC) that can be used to confirm measurements made by FIDGC. Method 625 provides gas chromatograph/mass spectrometer (GC/MS) conditions appropriate for the qualitative and quantitative confirmation of results for all of the parameters listed above, using the extract produced by this method.

1.3 The method detection limit (MDL, defined in Section 14.1)¹ for each parameter is listed in Table 1. The MDL for a specific wastewater may differ from those listed, depending upon the nature of interferences in the sample matrix. The MDL listed in Table 1 for each parameter was achieved with a flame ionization detector (FID). The MDLs that were achieved when the derivatization cleanup and electron capture detector (ECD) were employed are presented in Table 2.

1.4 Any modification of this method, beyond those expressly permitted, shall be considered as a major modification subject to application and approval of alternate test procedures under 40 CFR 136.4 and 136.5.

1.5 This method is restricted to use by or under the supervision of analysts experienced in the use of a gas chromatograph and in the interpretation of gas chromatograms. Each analyst must demonstrate the ability to generate acceptable results with this method using the procedure described in Section 8.2.

2. Summary of Method

2.1 A measured volume of sample, approximately 1-L, is acidified and extracted with methylene chloride using a separatory funnel. The methylene chloride extract is dried and exchanged to 2-propanol during concentration to a volume of 10 mL or less. The extract is separated by gas chromatography and the phenols are then measured with an FID.²

2.2 A preliminary sample wash under basic conditions can be employed for samples having high general organic and organic base interferences.

2.3 The method also provides for a derivatization and column chromatography cleanup procedure to aid in the elimination of interferences.^{2,3} The derivatives are analyzed by ECDGC.

3. Interferences

3.1 Method interferences may be caused by contaminants in solvents, reagents, glassware, and other sample processing hardware that lead to discrete artifacts and/or elevated baselines in gas chromatograms. All of these materials must be routinely demonstrated to be free from interferences under the conditions of the analysis by running laboratory reagent blanks as described in Section 8.1.3.

3.1.1 Glassware must be scrupulously cleaned.⁴ Clean all glassware as soon as possible after use by rinsing with the last solvent used in it. Solvent rinsing should be followed by detergent washing with hot water, and rinses with tap water and distilled water. The glassware should then be drained dry, and heated in a muffle furnace at 400 °C for 15 to 30 min. Some thermally stable materials, such as PCBs, may not be eliminated by this treatment. Solvent rinses with acetone and pesticide quality hexane may be substituted for the muffle furnace heating. Thorough rinsing with such solvents usually eliminates PCB interference. Volumetric ware should not be heated in a muffle furnace. After drying and cooling, glassware should be sealed and stored in a clean environment to prevent any accumulation of dust or other contaminants. Store inverted or capped with aluminum foil.

3.1.2 The use of high purity reagents and solvents helps to minimize interference problems. Purification of solvents by distillation in all-glass systems may be required.

3.2 Matrix interferences may be caused by contaminants that are coextracted from the sample. The extent of matrix interferences will vary considerably from source to source, depending upon the nature and diversity of the industrial complex or municipality being sampled. The derivatization cleanup procedure in Section 12 can be used to overcome many of these interferences, but unique samples may require additional cleanup approaches to achieve the MDL listed in Tables 1 and 2.

3.3 The basic sample wash (Section 10.2) may cause significantly reduced recovery of phenol and 2,4-dimethylphenol. The analyst must recognize that results obtained under these conditions are minimum concentrations.

4. Safety

4.1 The toxicity or carcinogenicity of each reagent used in this method has not been precisely defined; however, each chemical compound should be treated as a potential health hazard. From this viewpoint, exposure to these chemicals must be reduced to the lowest possible level by whatever means available. The laboratory is responsible for maintaining a current awareness file of OSHA regulations regarding the safe handling of the chemicals specified in this method. A reference file of material data handling sheets should also be made available to all personnel involved in the chemical analysis. Additional references to laboratory safety are available and have been identified^{5,7} for the information of analyst.

4.2 Special care should be taken in handling pentafluorobenzyl bromide, which is a lachrymator, and 18-crown-6-ether, which is highly toxic.

5. Apparatus and Materials

5.1 Sampling equipment, for discrete or composite sampling.

5.1.1 Grab sample bottle—1-L or 1-qt, amber glass, fitted with a screw cap lined with Teflon. Foil may be substituted for Teflon if the sample is not corrosive. If amber bottles are not available, protect samples from light. The bottle and cap liner must be washed, rinsed with acetone or methylene chloride, and dried before use to minimize contamination.

5.1.2 Automatic sampler (optional)—The sampler must incorporate glass sample containers for the collection of a minimum of 250 mL of sample. Sample containers must be kept refrigerated at 4°C and protected from light during compositing. If the sampler uses a peristaltic pump, a minimum length of compressible silicone rubber tubing may be

used. Before use, however, the compressible tubing should be thoroughly rinsed with methanol, followed by repeated rinsings with distilled water to minimize the potential for contamination of the sample. An integrating flow meter is required to collect flow proportional composites.

5.2 Glassware (All specifications are suggested. Catalog numbers are included for illustration only.):

5.2.1 Separatory funnel—2-L, with Teflon stopcock.

5.2.2 Drying column—Chromatographic column, 400 mm long × 19 mm ID, with coarse frit filter disc.

5.2.3 Chromatographic column—100 mm long × 10 mm ID, with Teflon stopcock.

5.2.4 Concentrator tube, Kuderna-Danish—10-mL, graduated (Kontes K-570050-1025 or equivalent). Calibration must be checked at the volumes employed in the test. Ground glass stopper is used to prevent evaporation of extracts.

5.2.5 Evaporative flask, Kuderna-Danish—500-mL (Kontes K-570001-0500 or equivalent). Attach to concentrator tube with springs.

5.2.6 Snyder column, Kuderna-Danish—Three-ball macro (Kontes K-503000-0121 or equivalent).

5.2.7 Snyder column, Kuderna-Danish—Two-ball micro (Kontes K-569001-0219 or equivalent).

5.2.8 Vials—10 to 15-mL, amber glass, with Teflon-lined screw cap.

5.2.9 Reaction flask—15 to 25-mL round bottom flask, with standard tapered joint, fitted with a water-cooled condenser and U-shaped drying tube containing granular calcium chloride.

5.3 Boiling chips—Approximately 10/40 mesh. Heat to 400 °C for 30 min or Soxhlet extract with methylene chloride.

5.4 Water bath—Heated, with concentric ring cover, capable of temperature control (±2°C). The bath should be used in a hood.

5.5 Balance—Analytical, capable of accurately weighting 0.0001 g.

5.6 Gas chromatograph—An analytical system complete with a temperature programmable gas chromatograph suitable for on-column injection and all required accessories including syringes, analytical columns, gases, detector, and strip-chart recorder. A data system is recommended for measuring peak areas.

5.6.1 Column for underivatized phenols—1.8 m long × 2 mm ID glass, packed with 1% SP-1240DA on Supelcoport (80/100 mesh) or equivalent. This column was used to develop the method performance statements in Section 14. Guidelines for the use of alternate column packings are provided in Section 11.1.

5.6.2 Column for derivatized phenols—1.8 m long × 2 mm ID glass, packed with 5% OV-17 on Chromosorb W-AW-DMCS (80/100 mesh) or equivalent. This column has proven effective

in the analysis of wastewaters for derivatization products of the parameters listed in the scope (Section 1.1), and was used to develop the method performance statements in Section 14. Guidelines for the use of alternate column packings are provided in Section 11.1.

5.6.3 Detectors—Flame ionization and electron capture detectors. The FID is used when determining the parent phenols. The ECD is used when determining the derivatized phenols. Guidelines for the use of alternate detectors are provided in Section 11.1.

6. Reagents

6.1 Reagent water—Reagent water is defined as a water in which an interferent is not observed at the MDL of the parameters of interest.

6.2 Sodium hydroxide solution (10 N)—Dissolve 40 g of NaOH (ACS) in reagent water and dilute to 100 mL.

6.3 Sodium hydroxide solution (1 N)—Dissolve 4 g of NaOH (ACS) in reagent water and dilute to 100 mL.

6.4 Sodium sulfate—(ACS) Granular, anhydrous. Purify by heating at 400°C for 4 h in a shallow tray.

6.5 Sodium thiosulfate—(ACS) Granular.

6.6 Sulfuric acid (1+1)—Slowly, add 50 mL of H₂SO₄ (ACS, sp. gr. 1.84) to 50 mL of reagent water.

6.7 Sulfuric acid (1 N)—Slowly, add 58 mL of H₂SO₄ (ACS, sp. gr. 1.84) to reagent water and dilute to 1 L.

6.8 Potassium carbonate—(ACS) Powdered.

6.9 Pentafluorobenzyl bromide (α -Bromopentafluorotoluene)—97% minimum purity.

NOTE: This chemical is a lachrymator. (See Section 4.2.)

6.10 18-crown-6-ether (1,4,7,10,13,16-Hexaoxacyclooctadecane)—98% minimum purity.

NOTE: This chemical is highly toxic.

6.11 Derivatization reagent—Add 1 mL of pentafluorobenzyl bromide and 1 g of 18-crown-6-ether to a 50-mL volumetric flask and dilute to volume with 2-propanol. Prepare fresh weekly. This operation should be carried out in a hood. Store at 4 °C and protect from light.

6.12 Acetone, hexane, methanol, methylene chloride, 2-propanol, toluene—Pesticide quality or equivalent.

6.13 Silica gel—100/200 mesh, Davison, grade-923 or equivalent. Activate at 130 °C overnight and store in a desiccator.

6.14 Stock standard solutions (1.00 µg/µL)—Stock standard solutions may be prepared from pure standard materials or purchased as certified solutions.

6.14.1 Prepare stock standard solutions by accurately weighing about 0.0100 g of pure material. Dissolve the material in 2-propanol

and dilute to volume in a 10-mL volumetric flask. Larger volumes can be used at the convenience of the analyst. When compound purity is assayed to be 96% or greater, the weight can be used without correction to calculate the concentration of the stock standard. Commercially prepared stock standards can be used at any concentration if they are certified by the manufacturer or by an independent source.

6.14.2 Transfer the stock standard solutions into Teflon-sealed screw-cap bottles. Store at 4 °C and protect from light. Stock standard solutions should be checked frequently for signs of degradation or evaporation, especially just prior to preparing calibration standards from them.

6.14.3 Stock standard solutions must be replaced after six months, or sooner if comparison with check standards indicates a problem.

6.15 Quality control check sample concentrate—See Section 8.2.1.

7. Calibration

7.1 To calibrate the FIDGC for the analysis of underivatized phenols, establish gas chromatographic operating conditions equivalent to those given in Table 1. The gas chromatographic system can be calibrated using the external standard technique (Section 7.2) or the internal standard technique (Section 7.3).

7.2 External standard calibration procedure for FIDGC:

7.2.1 Prepare calibration standards at a minimum of three concentration levels for each parameter of interest by adding volumes of one or more stock standards to a volumetric flask and diluting to volume with 2-propanol. One of the external standards should be at a concentration near, but above, the MDL (Table 1) and the other concentrations should correspond to the expected range of concentrations found in real samples or should define the working range of the detector.

7.2.2 Using injections of 2 to 5 µL, analyze each calibration standard according to Section 11 and tabulate peak height or area responses against the mass injected. The results can be used to prepare a calibration curve for each compound. Alternatively, if the ratio of response to amount injected (calibration factor) is a constant over the working range (<10% relative standard deviation, RSD), linearity through the origin can be assumed and the average ratio or calibration factor can be used in place of a calibration curve.

7.3 Internal standard calibration procedure for FIDGC—To use this approach, the analyst must select one or more internal standards that are similar in analytical behavior to the compounds of interest. The analyst must further demonstrate that the measurement of the internal standard is not

affected by method or matrix interferences. Because of these limitations, no internal standard can be suggested that is applicable to all samples.

7.3.1 Prepare calibration standards at a minimum of three concentration levels for each parameter of interest by adding volumes of one or more stock standards to a volumetric flask. To each calibration standard, add a known constant amount of one or more internal standards, and dilute to volume with 2-propanol. One of the standards should be at a concentration near, but above, the MDL and the other concentrations should correspond to the expected range of concentrations found in real samples or should define the working range of the detector.

7.3.2 Using injections of 2 to 5 µL, analyze each calibration standard according to Section 11 and tabulate peak height or area responses against concentration for each compound and internal standard. Calculate response factors (RF) for each compound using Equation 1.

$$RF = (A_s)(C_{is}) / (A_{is})(C_s) \quad \text{Equation 1}$$

where:

A_s=Response for the parameter to be measured.

A_{is}=Response for the internal standard.

C_{is}=Concentration of the internal standard (µg/L).

C_s=Concentration of the parameter to be measured (µg/L).

If the RF value over the working range is a constant (<10% RSD), the RF can be assumed to be invariant and the average RF can be used for calculations. Alternatively, the results can be used to plot a calibration curve of response ratios, A_s/A_{is}, vs. RF.

7.4 The working calibration curve, calibration factor, or RF must be verified on each working day by the measurement of one or more calibration standards. If the response for any parameter varies from the predicted response by more than ±15%, a new calibration curve must be prepared for that compound.

7.5 To calibrate the ECDGC for the analysis of phenol derivatives, establish gas chromatographic operating conditions equivalent to those given in Table 2.

7.5.1 Prepare calibration standards at a minimum of three concentration levels for each parameter of interest by adding volumes of one or more stock standards to a volumetric flask and diluting to volume with 2-propanol. One of the external standards should be at a concentration near, but above, the MDL (Table 2) and the other concentrations should correspond to the expected range of concentrations found in real samples or should define the working range of the detector.

7.5.2 Each time samples are to be derivatized, simultaneously treat a 1-mL aliquot of each calibration standard as described in Section 12.

7.5.3 After derivatization, analyze 2 to 5 μL of each column eluate collected according to the method beginning in Section 12.8 and tabulate peak height or area responses against the calculated equivalent mass of underivatized phenol injected. The results can be used to prepare a calibration curve for each compound.

7.6 Before using any cleanup procedure, the analyst must process a series of calibration standards through the procedure to validate elution patterns and the absence of interferences from the reagents.

8. Quality Control

8.1 Each laboratory that uses this method is required to operate a formal quality control program. The minimum requirements of this program consist of an initial demonstration of laboratory capability and an ongoing analysis of spiked samples to evaluate and document data quality. The laboratory must maintain records to document the quality of data that is generated. Ongoing data quality checks are compared with established performance criteria to determine if the results of analyses meet the performance characteristics of the method. When results of sample spikes indicate atypical method performance, a quality control check standard must be analyzed to confirm that the measurements were performed in an in-control mode of operation.

8.1.1 The analyst must make an initial, one-time, demonstration of the ability to generate acceptable accuracy and precision with this method. This ability is established as described in Section 8.2.

8.1.2 In recognition of advances that are occurring in chromatography, the analyst is permitted certain options (detailed in Sections 10.6 and 11.1) to improve the separations or lower the cost of measurements. Each time such a modification is made to the method, the analyst is required to repeat the procedure in Section 8.2.

8.1.3 Before processing any samples the analyst must analyze a reagent water blank to demonstrate that interferences from the analytical system and glassware are under control. Each time a set of samples is extracted or reagents are changed a reagent water blank must be processed as a safeguard against laboratory contamination.

8.1.4 The laboratory must, on an ongoing basis, spike and analyze a minimum of 10% of all samples to monitor and evaluate laboratory data quality. This procedure is described in Section 8.3.

8.1.5 The laboratory must, on an ongoing basis, demonstrate through the analyses of quality control check standards that the operation of the measurement system is in con-

trol. This procedure is described in Section 8.4. The frequency of the check standard analyses is equivalent to 10% of all samples analyzed but may be reduced if spike recoveries from samples (Section 8.3) meet all specified quality control criteria.

8.1.6 The laboratory must maintain performance records to document the quality of data that is generated. This procedure is described in Section 8.5.

8.2 To establish the ability to generate acceptable accuracy and precision, the analyst must perform the following operations.

8.2.1 A quality control (QC) check sample concentrate is required containing each parameter of interest at a concentration of 100 $\mu\text{g}/\text{mL}$ in 2-propanol. The QC check sample concentrate must be obtained from the U.S. Environmental Protection Agency, Environmental Monitoring and Support Laboratory in Cincinnati, Ohio, if available. If not available from that source, the QC check sample concentrate must be obtained from another external source. If not available from either source above, the QC check sample concentrate must be prepared by the laboratory using stock standards prepared independently from those used for calibration.

8.2.2 Using a pipet, prepare QC check samples at a concentration of 100 $\mu\text{g}/\text{L}$ by adding 1.00 mL of QC check sample concentrate to each of four 1-L aliquots of reagent water.

8.2.3 Analyze the well-mixed QC check samples according to the method beginning in Section 10.

8.2.4 Calculate the average recovery (\bar{X}) in $\mu\text{g}/\text{L}$, and the standard deviation of the recovery (s) in $\mu\text{g}/\text{L}$, for each parameter using the four results.

8.2.5 For each parameter compare s and \bar{X} with the corresponding acceptance criteria for precision and accuracy, respectively, found in Table 3. If s and \bar{X} for all parameters of interest meet the acceptance criteria, the system performance is acceptable and analysis of actual samples can begin. If any individual s exceeds the precision limit or any individual \bar{X} falls outside the range for accuracy, the system performance is unacceptable for that parameter.

NOTE: The large number of parameters in Table 3 present a substantial probability that one or more will fail at least one of the acceptance criteria when all parameters are analyzed.

8.2.6 When one or more of the parameters tested fail at least one of the acceptance criteria, the analyst must proceed according to Section 8.2.6.1 or 8.2.6.2.

8.2.6.1 Locate and correct the source of the problem and repeat the test for all parameters of interest beginning with Section 8.2.2.

8.2.6.2 Beginning with Section 8.2.2, repeat the test only for those parameters that failed to meet criteria. Repeated failure, however, will confirm a general problem

with the measurement system. If this occurs, locate and correct the source of the problem and repeat the test for all compounds of interest beginning with Section 8.2.2.

8.3 The laboratory must, on an ongoing basis, spike at least 10% of the samples from each sample site being monitored to assess accuracy. For laboratories analyzing one to ten samples per month, at least one spiked sample per month is required.

8.3.1 The concentration of the spike in the sample should be determined as follows:

8.3.1.1 If, as in compliance monitoring, the concentration of a specific parameter in the sample is being checked against a regulatory concentration limit, the spike should be at that limit or 1 to 5 times higher than the background concentration determined in Section 8.3.2, whichever concentration would be larger.

8.3.1.2 If the concentration of a specific parameter in the sample is not being checked against a limit specific to that parameter, the spike should be at 100 µg/L or 1 to 5 times higher than the background concentration determined in Section 8.3.2, whichever concentration would be larger.

8.3.1.3 If it is impractical to determine background levels before spiking (e.g., maximum holding times will be exceeded), the spike concentration should be (1) the regulatory concentration limit, if any, or, if none, (2) the larger of either 5 times higher than the expected background concentration or 100 µg/L.

8.3.2 Analyze one sample aliquot to determine the background concentration (B) of each parameter. If necessary, prepare a new QC check sample concentrate (Section 8.2.1) appropriate for the background concentrations in the sample. Spike a second sample aliquot with 1.0 mL of the QC check sample concentrate and analyze it to determine the concentration after spiking (A) of each parameter. Calculate each percent recovery (P) as $100(A-B)/T$, where T is the known true value of the spike.

8.3.3 Compare the percent recovery (P) for each parameter with the corresponding QC acceptance criteria found in Table 3. These acceptance criteria were calculated to include an allowance for error in measurement of both the background and spike concentrations, assuming a spike to background ratio of 5:1. This error will be accounted for to the extent that the analyst's spike to background ratio approaches 5:1.⁸ If spiking was performed at a concentration lower than 100 µg/L, the analyst must use either the QC acceptance criteria in Table 3, or optional QC acceptance criteria calculated for the specific spike concentration. To calculate optional acceptance criteria for the recovery of a parameter: (1) Calculate accuracy (X') using the equation in Table 4, substituting the spike concentration (T) for C; (2) calculate overall precision (S') using the equa-

tion in Table 4, substituting X' for \bar{X} ; (3) calculate the range for recovery at the spike concentration as $(100 X'/T) \pm 2.44(100 S'/T)\%$.⁸

8.3.4 If any individual P falls outside the designated range for recovery, that parameter has failed the acceptance criteria. A check standard containing each parameter that failed the criteria must be analyzed as described in Section 8.4.

8.4 If any parameter fails the acceptance criteria for recovery in Section 8.3, a QC check standard containing each parameter that failed must be prepared and analyzed.

NOTE: The frequency for the required analysis of a QC check standard will depend upon the number of parameters being simultaneously tested, the complexity of the sample matrix, and the performance of the laboratory.

8.4.1 Prepare the QC check standard by adding 1.0 mL of QC check sample concentrate (Section 8.2.1 or 8.3.2) to 1 L of reagent water. The QC check standard needs only to contain the parameters that failed criteria in the test in Section 8.3.

8.4.2 Analyze the QC check standard to determine the concentration measured (A) of each parameter. Calculate each percent recovery (P_s) as $100(A/T)\%$, where T is the true value of the standard concentration.

8.4.3 Compare the percent recovery (P_s) for each parameter with the corresponding QC acceptance criteria found in Table 3. Only parameters that failed the test in Section 8.3 need to be compared with these criteria. If the recovery of any such parameter falls outside the designated range, the laboratory performance for that parameter is judged to be out of control, and the problem must be immediately identified and corrected. The analytical result for that parameter in the unspiked sample is suspect and may not be reported for regulatory compliance purposes.

8.5 As part of the QC program for the laboratory, method accuracy for wastewater samples must be assessed and records must be maintained. After the analysis of five spiked wastewater samples as in Section 8.3, calculate the average percent recovery (\bar{P}) and the standard deviation of the percent recovery (s_p). Express the accuracy assessment as a percent recovery interval from $\bar{P} - 2s_p$ to $\bar{P} + 2s_p$. If $\bar{P} = 90\%$ and $s_p = 10\%$, for example, the accuracy interval is expressed as 70–110%. Update the accuracy assessment for each parameter on a regular basis (e.g. after each five to ten new accuracy measurements).

8.6. It is recommended that the laboratory adopt additional quality assurance practices for use with this method. The specific practices that are most productive depend upon the needs of the laboratory and the nature of the samples. Field duplicates may be analyzed to assess the precision of the environmental measurements. When doubt exists over the identification of a peak

on the chromatogram, confirmatory techniques such as gas chromatography with a dissimilar column, specific element detector, or mass spectrometer must be used. Whenever possible, the laboratory should analyze standard reference materials and participate in relevant performance evaluation studies.

9. Sample Collection, Preservation, and Handling

9.1 Grab samples must be collected in glass containers. Conventional sampling practices⁹ should be followed, except that the bottle must not be prerinsed with sample before collection. Composite samples should be collected in refrigerated glass containers in accordance with the requirements of the program. Automatic sampling equipment must be as free as possible of Tygon tubing and other potential sources of contamination.

9.2 All samples must be iced or refrigerated at 4 °C from the time of collection until extraction. Fill the sample bottles and, if residual chlorine is present, add 80 mg of sodium thiosulfate per liter of sample and mix well. EPA Methods 330.4 and 330.5 may be used for measurement of residual chlorine.¹⁰ Field test kits are available for this purpose.

9.3 All samples must be extracted within 7 days of collection and completely analyzed within 40 days of extraction.²

10. Sample Extraction

10.1 Mark the water meniscus on the side of sample bottle for later determination of sample volume. Pour the entire sample into a 2-L separatory funnel.

10.2 For samples high in organic content, the analyst may solvent wash the sample at basic pH as prescribed in Sections 10.2.1 and 10.2.2 to remove potential method interferences. Prolonged or exhaustive contact with solvent during the wash may result in low recovery of some of the phenols, notably phenol and 2,4-dimethylphenol. For relatively clean samples, the wash should be omitted and the extraction, beginning with Section 10.3, should be followed.

10.2.1 Adjust the pH of the sample to 12.0 or greater with sodium hydroxide solution.

10.2.2 Add 60 mL of methylene chloride to the sample by shaking the funnel for 1 min with periodic venting to release excess pressure. Discard the solvent layer. The wash can be repeated up to two additional times if significant color is being removed.

10.3 Adjust the sample to a pH of 1 to 2 with sulfuric acid.

10.4 Add 60 mL of methylene chloride to the sample bottle, seal, and shake 30 s to rinse the inner surface. Transfer the solvent to the separatory funnel and extract the sample by shaking the funnel for 2 min. with periodic venting to release excess pressure.

Allow the organic layer to separate from the water phase for a minimum of 10 min. If the emulsion interface between layers is more than one-third the volume of the solvent layer, the analyst must employ mechanical techniques to complete the phase separation. The optimum technique depends upon the sample, but may include stirring, filtration of the emulsion through glass wool, centrifugation, or other physical methods. Collect the methylene chloride extract in a 250-mL Erlenmeyer flask.

10.5 Add a second 60-mL volume of methylene chloride to the sample bottle and repeat the extraction procedure a second time, combining the extracts in the Erlenmeyer flask. Perform a third extraction in the same manner.

10.6 Assemble a Kuderna-Danish (K-D) concentrator by attaching a 10-mL concentrator tube to a 500-mL evaporative flask. Other concentration devices or techniques may be used in place of the K-D concentrator if the requirements of Section 8.2 are met.

10.7 Pour the combined extract through a solvent-rinsed drying column containing about 10 cm of anhydrous sodium sulfate, and collect the extract in the K-D concentrator. Rinse the Erlenmeyer flask and column with 20 to 30 mL of methylene chloride to complete the quantitative transfer.

10.8 Add one or two clean boiling chips to the evaporative flask and attach a three-ball Snyder column. Prewet the Snyder column by adding about 1 mL of methylene chloride to the top. Place the K-D apparatus on a hot water bath (60 to 65 °C) so that the concentrator tube is partially immersed in the hot water, and the entire lower rounded surface of the flask is bathed with hot vapor. Adjust the vertical position of the apparatus and the water temperature as required to complete the concentration in 15 to 20 min. At the proper rate of distillation the balls of the column will actively chatter but the chambers will not flood with condensed solvent. When the apparent volume of liquid reaches 1 mL, remove the K-D apparatus and allow it to drain and cool for at least 10 min.

10.9 Increase the temperature of the hot water bath to 95 to 100 °C. Remove the Snyder column and rinse the flask and its lower joint into the concentrator tube with 1 to 2 mL of 2-propanol. A 5-mL syringe is recommended for this operation. Attach a two-ball micro-Snyder column to the concentrator tube and prewet the column by adding about 0.5 mL of 2-propanol to the top. Place the micro-K-D apparatus on the water bath so that the concentrator tube is partially immersed in the hot water. Adjust the vertical position of the apparatus and the water temperature as required to complete concentration in 5 to 10 min. At the proper rate of distillation the balls of the column will actively chatter but the chambers will

not flood. When the apparent volume of liquid reaches 2.5 mL, remove the K-D apparatus and allow it to drain and cool for at least 10 min. Add an additional 2 mL of 2-propanol through the top of the micro-Snyder column and resume concentrating as before. When the apparent volume of liquid reaches 0.5 mL, remove the K-D apparatus and allow it to drain and cool for at least 10 min.

10.10 Remove the micro-Snyder column and rinse its lower joint into the concentrator tube with a minimum amount of 2-propanol. Adjust the extract volume to 1.0 mL. Stopper the concentrator tube and store refrigerated at 4 °C if further processing will not be performed immediately. If the extract will be stored longer than two days, it should be transferred to a Teflon-sealed screw-cap vial. If the sample extract requires no further cleanup, proceed with FIDGC analysis (Section 11). If the sample requires further cleanup, proceed to Section 12.

10.11 Determine the original sample volume by refilling the sample bottle to the mark and transferring the liquid to a 1000-mL graduated cylinder. Record the sample volume to the nearest 5 mL.

11. Flame Ionization Detector Gas Chromatography

11.1 Table 1 summarizes the recommended operating conditions for the gas chromatograph. Included in this table are retention times and MDL that can be achieved under these conditions. An example of the separations achieved by this column is shown in Figure 1. Other packed or capillary (open-tubular) columns, chromatographic conditions, or detectors may be used if the requirements of Section 8.2 are met.

11.2 Calibrate the system daily as described in Section 7.

11.3 If the internal standard calibration procedure is used, the internal standard must be added to the sample extract and mixed thoroughly immediately before injection into the gas chromatograph.

11.4 Inject 2 to 5 μ L of the sample extract or standard into the gas chromatograph using the solvent-flush technique.¹¹ Smaller (1.0 μ L) volumes may be injected if automatic devices are employed. Record the volume injected to the nearest 0.05 μ L, and the resulting peak size in area or peak height units.

11.5 Identify the parameters in the sample by comparing the retention times of the peaks in the sample chromatogram with those of the peaks in standard chromatograms. The width of the retention time window used to make identifications should be based upon measurements of actual retention time variations of standards over the course of a day. Three times the standard deviation of a retention time for a compound may be used to calculate a sug-

gested window size; however, the experience of the analyst should weigh heavily in the interpretation of chromatograms.

11.6 If the response for a peak exceeds the working range of the system, dilute the extract and reanalyze.

11.7 If the measurement of the peak response is prevented by the presence of interferences, an alternative gas chromatographic procedure is required. Section 12 describes a derivatization and column chromatographic procedure which has been tested and found to be a practical means of analyzing phenols in complex extracts.

12. Derivatization and Electron Capture Detector Gas Chromatography

12.1 Pipet a 1.0-mL aliquot of the 2-propanol solution of standard or sample extract into a glass reaction vial. Add 1.0 mL of derivatizing reagent (Section 6.11). This amount of reagent is sufficient to derivatize a solution whose total phenolic content does not exceed 0.3 mg/mL.

12.2 Add about 3 mg of potassium carbonate to the solution and shake gently.

12.3 Cap the mixture and heat it for 4 h at 80 °C in a hot water bath.

12.4 Remove the solution from the hot water bath and allow it to cool.

12.5 Add 10 mL of hexane to the reaction flask and shake vigorously for 1 min. Add 3.0 mL of distilled, deionized water to the reaction flask and shake for 2 min. Decant a portion of the organic layer into a concentrator tube and cap with a glass stopper.

12.6 Place 4.0 g of silica gel into a chromatographic column. Tap the column to settle the silica gel and add about 2 g of anhydrous sodium sulfate to the top.

12.7 Preequilibrate the column with 6 mL of hexane. Discard the eluate and just prior to exposure of the sodium sulfate layer to the air, pipet onto the column 2.0 mL of the hexane solution (Section 12.5) that contains the derivatized sample or standard. Elute the column with 10.0 mL of hexane and discard the eluate. Elute the column, in order, with: 10.0 mL of 15% toluene in hexane (Fraction 1); 10.0 mL of 40% toluene in hexane (Fraction 2); 10.0 mL of 75% toluene in hexane (Fraction 3); and 10.0 mL of 15% 2-propanol in toluene (Fraction 4). All elution mixtures are prepared on a volume: volume basis. Elution patterns for the phenolic derivatives are shown in Table 2. Fractions may be combined as desired, depending upon the specific phenols of interest or level of interferences.

12.8 Analyze the fractions by ECDGC. Table 2 summarizes the recommended operating conditions for the gas chromatograph. Included in this table are retention times and MDL that can be achieved under these conditions. An example of the separations achieved by this column is shown in Figure 2.

12.9 Calibrate the system daily with a minimum of three aliquots of calibration standards, containing each of the phenols of interest that are derivatized according to Section 7.5.

12.10 Inject 2 to 5 μL of the column fractions into the gas chromatograph using the solvent-flush technique. Smaller (1.0 μL) volumes can be injected if automatic devices are employed. Record the volume injected to the nearest 0.05 μL , and the resulting peak size in area or peak height units. If the peak response exceeds the linear range of the system, dilute the extract and reanalyze.

13. Calculations

13.1 Determine the concentration of individual compounds in the sample analyzed by FIDGC (without derivatization) as indicated below.

13.1.1 If the external standard calibration procedure is used, calculate the amount of material injected from the peak response using the calibration curve or calibration factor determined in Section 7.2.2. The concentration in the sample can be calculated from Equation 2.

$$\text{Concentration } (\mu\text{g/L}) = \frac{(A)(V_t)}{(V_i)(V_s)}$$

Equation 2

where:

A=Amount of material injected (ng).

V_i =Volume of extract injected (μL).

V_t =Volume of total extract (μL).

V_s =Volume of water extracted (mL).

13.1.2 If the internal standard calibration procedure is used, calculate the concentration in the sample using the response factor (RF) determined in Section 7.3.2 and Equation 3.

$$\text{Concentration } (\mu\text{g/L}) = \frac{(A_s)(I_s)}{(A_{is})(\text{RF})(V_o)}$$

Equation 3

where:

A_s =Response for the parameter to be measured.

A_{is} =Response for the internal standard.

I_s =Amount of internal standard added to each extract (μg).

V_o =Volume of water extracted (L).

13.2 Determine the concentration of individual compounds in the sample analyzed by derivatization and ECDGC according to Equation 4.

$$\text{Concentration } (\mu\text{g/L}) = \frac{(A)(V_t)(B)(D)}{(V_i)(V_s)(C)(E)}$$

Equation 4

where:

A=Mass of underivatized phenol represented by area of peak in sample chromatogram, determined from calibration curve in Section 7.5.3 (ng).

V_i =Volume of eluate injected (μL).

V_t =Total volume of column eluate or combined fractions from which V_i was taken (μL).

V_s =Volume of water extracted in Section 10.10 (mL).

B=Total volume of hexane added in Section 12.5 (mL).

C=Volume of hexane sample solution added to cleanup column in Section 12.7 (mL).

D=Total volume of 2-propanol extract prior to derivatization (mL).

E=Volume of 2-propanol extract carried through derivatization in Section 12.1 (mL).

13.3 Report results in $\mu\text{g/L}$ without correction for recovery data. All QC data obtained should be reported with the sample results.

14. Method Performance

14.1 The method detection limit (MDL) is defined as the minimum concentration of a substance that can be measured and reported with 99% confidence that the value is above zero.¹ The MDL concentrations listed in Tables 1 and 2 were obtained using reagent water.¹² Similar results were achieved using representative wastewaters. The MDL actually achieved in a given analysis will vary depending on instrument sensitivity and matrix effects.

14.2 This method was tested by 20 laboratories using reagent water, drinking water, surface water, and three industrial wastewaters spiked as six concentrations over the range 12 to 450 $\mu\text{g/L}$.¹³ Single operator precision, overall precision, and method accuracy were found to be directly related to the concentration of the parameter and essentially independent of the sample matrix. Linear equations to describe these relationships for a flame ionization detector are presented in Table 4.

References

- 40 CFR part 136, appendix B.
- "Determination of Phenols in Industrial and Municipal Wastewaters," EPA 600/4-84-ABC, National Technical Information Service, PBXYZ, Springfield, Virginia 22161, November 1984.
- Kawahara, F. K. "Microdetermination of Derivatives of Phenols and Mercaptans by Means of Electron Capture Gas Chromatography," *Analytical Chemistry*, 40, 1009 (1968).
- ASTM Annual Book of Standards, Part 31, D3694-78. "Standard Practices for Preparation of Sample Containers and for Preservation of Organic Constituents," American

Society for Testing and Materials, Philadelphia.

5. "Carcinogens—Working With Carcinogens," Department of Health, Education, and Welfare, Public Health Service, Center for Disease Control, National Institute for Occupational Safety and Health, Publication No. 77-206, August 1977.

6. "OSHA Safety and Health Standards, General Industry," (29 CFR part 1910), Occupational Safety and Health Administration, OSHA 2206 (Revised, January 1976).

7. "Safety in Academic Chemistry Laboratories," American Chemical Society Publication, Committee on Chemical Safety, 3rd Edition, 1979.

8. Provost, L. P., and Elder, R. S. "Interpretation of Percent Recovery Data," *American Laboratory*, 15, 58-63 (1983). (The value 2.44 used in the equation in Section 8.3.3 is two times the value 1.22 derived in this report.)

9. ASTM Annual Book of Standards, Part 31, D3370-76. "Standard Practices for Sampling Water," American Society for Testing and Materials, Philadelphia.

10. "Methods 330.4 (Titrimetric, DPD-FAS) and 330.5 (Spectrophotometric, DPD) for Chlorine, Total Residual," Methods for Chemical Analysis of Water and Wastes, EPA-600/4-79-020, U.S. Environmental Protection Agency, Environmental Monitoring and Support Laboratory, Cincinnati, Ohio 45268, March 1979.

11. Burke, J. A. "Gas Chromatography for Pesticide Residue Analysis; Some Practical Aspects," *Journal of the Association of Official Analytical Chemists*, 48, 1037 (1965).

12. "Development of Detection Limits, EPA Method 604, Phenols," Special letter report for EPA Contract 68-03-2625, U.S. Environmental Protection Agency, Environmental Monitoring and Support Laboratory, Cincinnati, Ohio 45268.

13. "EPA Method Study 14 Method 604-Phenols," EPA 600/4-84-044, National Technical Information Service, PB84-196211, Springfield, Virginia 22161, May 1984.

TABLE 1—CHROMATOGRAPHIC CONDITIONS AND METHOD DETECTION LIMITS

| Parameter | Retention time (min) | Method detection limit (µg/L) |
|----------------------------------|----------------------|-------------------------------|
| 2-Chlorophenol | 1.70 | 0.31 |
| 2-Nitrophenol | 2.00 | 0.45 |
| Phenol | 3.01 | 0.14 |
| 2,4-Dimethylphenol | 4.03 | 0.32 |
| 2,4-Dichlorophenol | 4.30 | 0.39 |
| 2,4,6-Trichlorophenol | 6.05 | 0.64 |
| 4-Chloro-3-methylphenol | 7.50 | 0.36 |
| 2,4-Dinitrophenol | 10.00 | 13.0 |
| 2-Methyl-4,6-dinitrophenol | 10.24 | 16.0 |
| Pentachlorophenol | 12.42 | 7.4 |
| 4-Nitrophenol | 24.25 | 2.8 |

Column conditions: Supelcoport (80/100 mesh) coated with 1% SP-1240DA packed in a 1.8 m long x 2 mm ID glass column with nitrogen carrier gas at 30 mL/min flow rate. Column temperature was 80 °C at injection, programmed immediately at 8 °C/min to 150 °C final temperature. MDL were determined with an FID.

TABLE 2—SILICA GEL FRACTIONATION AND ELECTRON CAPTURE GAS CHROMATOGRAPHY OF PFBB DERIVATIVES

| Parent compound | Percent recovery by fraction ^a | | | | Retention time (min) | Method detection limit (µg/L) |
|-------------------------------|---|-------|----|-------|----------------------|-------------------------------|
| | 1 | 2 | 3 | 4 | | |
| 2-Chlorophenol | | 90 | 1 | | 3.3 | 0.58 |
| 2-Nitrophenol | | | 9 | 90 | 9.1 | 0.77 |
| Phenol | | 90 | 10 | | 1.8 | 2.2 |
| 2,4-Dimethylphenol | | 95 | 7 | | 2.9 | 0.63 |
| 2,4-Dichlorophenol | | 95 | 1 | | 5.8 | 0.68 |
| 2,4,6-Trichlorophenol | | 50 | 50 | | 7.0 | 0.58 |
| 4-Chloro-3-methylphenol | | 84 | 14 | | 4.8 | 1.8 |
| Pentachlorophenol | | 75 | 20 | | 28.8 | 0.59 |
| 4-Nitrophenol | | | 1 | 90 | 14.0 | 0.70 |

Column conditions: Chromosorb W-AW-DMCS (80/100 mesh) coated with 5% OV-17 packed in a 1.8 m long x 2.0 mm ID glass column with 5% methane/95% argon carrier gas at 30 mL/min flow rate. Column temperature held isothermal at 200 °C. MDL were determined with an ECD.

^aEluant composition:
 Fraction 1—15% toluene in hexane.
 Fraction 2—40% toluene in hexane.
 Fraction 3—75% toluene in hexane.
 Fraction 4—15% 2-propanol in toluene.

TABLE 3—QC ACCEPTANCE CRITERIA—METHOD 604

| Parameter | Test conc. (µg/L) | Limit for s (µg/L) | Range for \bar{X} (µg/L) | Range for P, P ₂ (percent) |
|----------------------------------|-------------------|--------------------|----------------------------|---------------------------------------|
| 4-Chloro-3-methylphenol | 100 | 16.6 | 56.7–113.4 | 49–122 |
| 2-Chlorophenol | 100 | 27.0 | 54.1–110.2 | 38–126 |
| 2,4-Dichlorophenol | 100 | 25.1 | 59.7–103.3 | 44–119 |
| 2,4-Dimethylphenol | 100 | 33.3 | 50.4–100.0 | 24–118 |
| 4,6-Dinitro-2-methylphenol | 100 | 25.0 | 42.4–123.6 | 30–136 |
| 2,4-Dinitrophenol | 100 | 36.0 | 31.7–125.1 | 12–145 |
| 2-Nitrophenol | 100 | 22.5 | 56.6–103.8 | 43–117 |
| 4-Nitrophenol | 100 | 19.0 | 22.7–100.0 | 13–110 |
| Pentachlorophenol | 100 | 32.4 | 56.7–113.5 | 36–134 |
| Phenol | 100 | 14.1 | 32.4–100.0 | 23–108 |
| 2,4,6-Trichlorophenol | 100 | 16.6 | 60.8–110.4 | 53–119 |

s—Standard deviation of four recovery measurements, in µg/L (Section 8.2.4).

\bar{X} —Average recovery for four recovery measurements, in µg/L (Section 8.2.4).

P, P₂—Percent recovery measured (Section 8.3.2, Section 8.4.2).

NOTE: These criteria are based directly upon the method performance data in Table 4. Where necessary, the limits for recovery have been broadened to assure applicability of the limits to concentrations below those used to develop Table 4.

TABLE 4—METHOD ACCURACY AND PRECISION AS FUNCTIONS OF CONCENTRATION—METHOD 604

| Parameter | Accuracy, as recovery, \bar{X}' (µg/L) | Single Analyst precision, s'_s (µg/L) | Overall precision, S' (µg/L) |
|----------------------------------|--|---|--------------------------------|
| 4-Chloro-3-methylphenol | 0.87C–1.97 | 0.11 \bar{X} –0.21 | 0.16 \bar{X} +1.41 |
| 2-Chlorophenol | 0.83C–0.84 | 0.18 \bar{X} +0.20 | 0.21 \bar{X} +0.75 |
| 2,4-Dichlorophenol | 0.81C+0.48 | 0.17 \bar{X} –0.02 | 0.18 \bar{X} +0.62 |
| 2,4-Dimethylphenol | 0.62C–1.64 | 0.30 \bar{X} –0.89 | 0.25 \bar{X} +0.48 |
| 4,6-Dinitro-2-methylphenol | 0.84C–1.01 | 0.15 \bar{X} +1.25 | 0.19 \bar{X} +5.85 |
| 2,4-Dinitrophenol | 0.80C–1.58 | 0.27 \bar{X} –1.15 | 0.29 \bar{X} +4.51 |
| 2-Nitrophenol | 0.81C–0.76 | 0.15 \bar{X} +0.44 | 0.14 \bar{X} +3.84 |
| 4-Nitrophenol | 0.46C+0.18 | 0.17 \bar{X} +2.43 | 0.19 \bar{X} +4.79 |
| Pentachlorophenol | 0.83C+2.07 | 0.22 \bar{X} –0.58 | 0.23 \bar{X} +0.57 |
| Phenol | 0.43C+0.11 | 0.20 \bar{X} –0.88 | 0.17 \bar{X} +0.77 |
| 2,4,6-Trichlorophenol | 0.86C–0.40 | 0.10 \bar{X} +0.53 | 0.13 \bar{X} +2.40 |

\bar{X}' =Expected recovery for one or more measurements of a sample containing a concentration of C, in µg/L.

s'_s =Expected single analyst standard deviation of measurements at an average concentration found of \bar{X} , in µg/L.

S' =Expected interlaboratory standard deviation of measurements at an average concentration found of \bar{X} , in µg/L.

C=True value for the concentration, in µg/L.

\bar{X} =Average recovery found for measurements of samples containing a concentration of C, in µg/L.

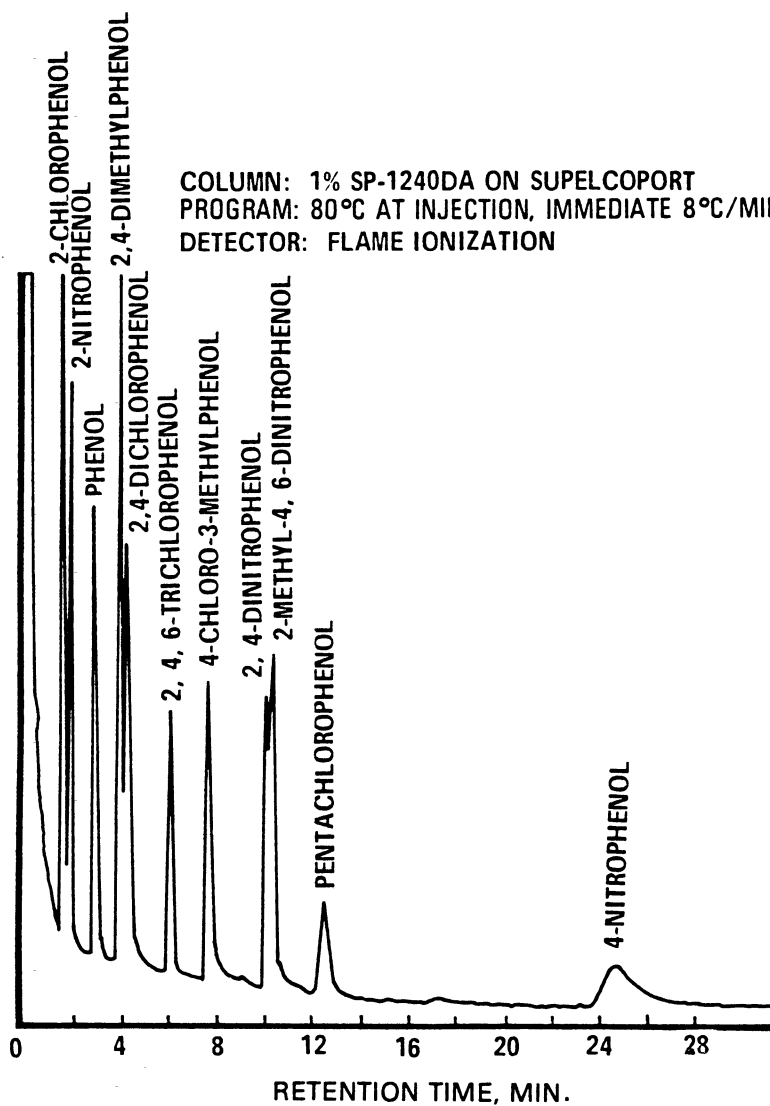

Figure 1. Gas chromatogram of phenols.

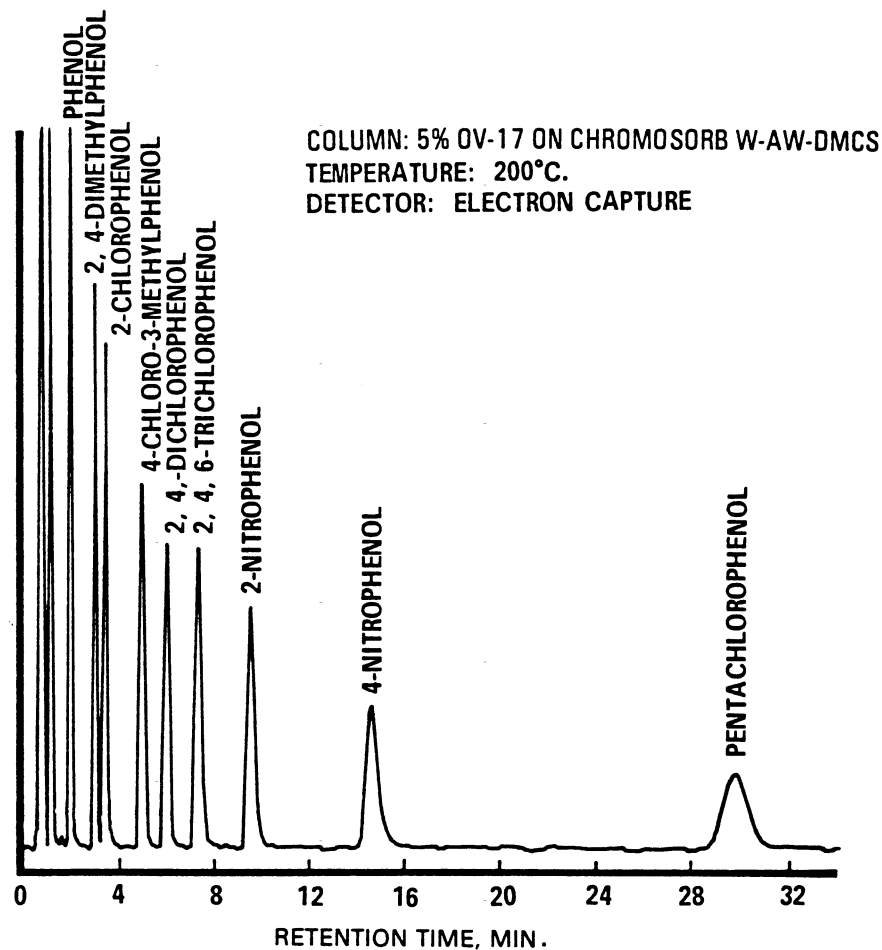

Figure 2. Gas chromatogram of PFB derivatives of phenols.

METHOD 605—BENZIDINES

1. Scope and Application

1.1 This method covers the determination of certain benzidines. The following parameters can be determined by this method:

| Parameter | Storet No | CAS No. |
|------------------------------|-----------|---------|
| Benzidine | 39120 | 92-87-5 |
| 3,3'-Dichlorobenzidine | 34631 | 91-94-1 |

1.2 This is a high performance liquid chromatography (HPLC) method applicable to the determination of the compounds listed above in municipal and industrial discharges

as provided under 40 CFR 136.1. When this method is used to analyze unfamiliar samples for the compounds above, identifications should be supported by at least one additional qualitative technique. This method describes electrochemical conditions at a second potential which can be used to confirm measurements made with this method. Method 625 provides gas chromatograph/mass spectrometer (GC/MS) conditions appropriate for the qualitative and quantitative confirmation of results for the parameters listed above, using the extract produced by this method.

1.3 The method detection limit (MDL, defined in Section 14.1)¹ for each parameter is

listed in Table 1. The MDL for a specific wastewater may differ from those listed, depending upon the nature of the interferences in the sample matrix.

1.4 Any modification of this method, beyond those expressly permitted, shall be considered as a major modification subject to application and approval of alternate test procedures under 40 CFR 136.4 and 136.5.

1.5 This method is restricted to use by or under the supervision of analysts experienced in the use of HPLC instrumentation and in the interpretation of liquid chromatograms. Each analyst must demonstrate the ability to generate acceptable results with this method using the procedure described in Section 8.2.

2. Summary of Method

2.1 A measured volume of sample, approximately 1-L, is extracted with chloroform using liquid-liquid extractions in a separatory funnel. The chloroform extract is extracted with acid. The acid extract is then neutralized and extracted with chloroform. The final chloroform extract is exchanged to methanol while being concentrated using a rotary evaporator. The extract is mixed with buffer and separated by HPLC. The benzidine compounds are measured with an electrochemical detector.²

2.2 The acid back-extraction acts as a general purpose cleanup to aid in the elimination of interferences.

3. Interferences

3.1 Method interferences may be caused by contaminants in solvents, reagents, glassware, and other sample processing hardware that lead to discrete artifacts and/or elevated baselines in chromatograms. All of these materials must be routinely demonstrated to be free from interferences under the conditions of the analysis by running laboratory reagent blanks as described in Section 8.1.3.

3.1.1 Glassware must be scrupulously cleaned.³ Clean all glassware as soon as possible after use by rinsing with the last solvent used in it. Solvent rinsing should be followed by detergent washing with hot water, and rinses with tap water and distilled water. The glassware should then be drained dry, and heated in a muffle furnace at 400 °C for 15 to 30 min. Some thermally stable materials may not be eliminated by this treatment. Solvent rinses with acetone and pesticide quality hexane may be substituted for the muffle furnace heating. Volumetric ware should not be heated in a muffle furnace. After drying and cooling, glassware should be sealed and stored in a clean environment to prevent any accumulation of dust or other contaminants. Store inverted or capped with aluminum foil.

3.1.2 The use of high purity reagents and solvents helps to minimize interference problems. Purification of solvents by distillation in all-glass systems may be required.

3.2 Matrix interferences may be caused by contaminants that are co-extracted from the sample. The extent of matrix interferences will vary considerably from source to source, depending upon the nature and diversity of the industrial complex or municipality being sampled. The cleanup procedures that are inherent in the extraction step are used to overcome many of these interferences, but unique samples may require additional cleanup approaches to achieve the MDL listed in Table 1.

3.3 Some dye plant effluents contain large amounts of components with retention times closed to benzidine. In these cases, it has been found useful to reduce the electrode potential in order to eliminate interferences and still detect benzidine. (See Section 12.7.)

4. Safety

4.1 The toxicity or carcinogenicity of each reagent used in this method has not been precisely defined; however, each chemical compound should be treated as a potential health hazard. From this viewpoint, exposure to these chemicals must be reduced to the lowest possible level by whatever means available. The laboratory is responsible for maintaining a current awareness file of OSHA regulations regarding the safe handling of the chemicals specified in this method. A reference file of material data handling sheets should also be made available to all personnel involved in the chemical analysis. Additional references to laboratory safety are available and have been identified^{4,6} for the information of the analyst.

4.2 The following parameters covered by this method have been tentatively classified as known or suspected, human or mammalian carcinogens: benzidine and 3,3'-dichlorobenzidine. Primary standards of these toxic compounds should be prepared in a hood. A NIOSH/MESA approved toxic gas respirator should be worn when the analyst handles high concentrations of these toxic compounds.

4.3 Exposure to chloroform should be minimized by performing all extractions and extract concentrations in a hood or other well-ventilated area.

5. Apparatus and Materials

5.1 Sampling equipment, for discrete or composite sampling.

5.1.1 Grab sample bottle—1-L or 1-qt, amber glass, fitted with a screw cap lined with Teflon. Foil may be substituted for Teflon if the sample is not corrosive. If amber bottles are not available, protect samples from light. The bottle and cap liner must be washed, rinsed with acetone or methylene

chloride, and dried before use to minimize contamination.

5.1.2 Automatic sampler (optional)—The sampler must incorporate glass sample containers for the collection of a minimum of 250 mL of sample. Sample containers must be kept refrigerated at 4°C and protected from light during compositing. If the sampler uses a peristaltic pump, a minimum length of compressible silicone rubber tubing may be used. Before use, however, the compressible tubing should be thoroughly rinsed with methanol, followed by repeated rinsings with distilled water to minimize the potential for contamination of the sample. An integrating flow meter is required to collect flow proportional composites.

5.2 Glassware (All specifications are suggested):

5.2.1 Separatory funnels—2000, 1000, and 250-mL, with Teflon stopcock.

5.2.2 Vials—10 to 15-mL, amber glass, with Teflon-lined screw cap.

5.2.3 Rotary evaporator.

5.2.4 Flasks—Round bottom, 100-mL, with 24/40 joints.

5.2.5 Centrifuge tubes—Conical, graduated, with Teflon-lined screw caps.

5.2.6 Pipettes—Pasteur, with bulbs.

5.3 Balance—Analytical, capable of accurately weighing 0.0001 g.

5.4 High performance liquid chromatograph (HPLC)—An analytical system complete with column supplies, high pressure syringes, detector, and compatible recorder. A data system is recommended for measuring peak areas and retention times.

5.4.1 Solvent delivery system—With pulse damper, Altex 110A or equivalent.

5.4.2 Injection valve (optional)—Waters U6K or equivalent.

5.4.3 Electrochemical detector—Bio-analytical Systems LC-2A with glassy carbon electrode, or equivalent. This detector has proven effective in the analysis of wastewaters for the parameters listed in the scope (Section 1.1), and was used to develop the method performance statements in Section 14. Guidelines for the use of alternate detectors are provided in Section 12.1.

5.4.4 Electrode polishing kit—Princeton Applied Research Model 9320 or equivalent.

5.4.5 Column—Lichrosorb RP-2, 5 micron particle diameter, in a 25 cm × 4.6 mm ID stainless steel column. This column was used to develop the method performance statements in Section 14. Guidelines for the use of alternate column packings are provided in Section 12.1.

6. Reagents

6.1 Reagent water—Reagent water is defined as a water in which an interferent is not observed at the MDL of the parameters of interest.

6.2 Sodium hydroxide solution (5 N)—Dissolve 20 g of NaOH (ACS) in reagent water and dilute to 100 mL.

6.3 Sodium hydroxide solution (1 M)—Dissolve 40 g of NaOH (ACS) in reagent water and dilute to 1 L.

6.4 Sodium thiosulfate—(ACS) Granular.

6.5 Sodium tribasic phosphate (0.4 M)—Dissolve 160 g of trisodium phosphate dodecahydrate (ACS) in reagent water and dilute to 1 L.

6.6 Sulfuric acid (1+1)—Slowly, add 50 mL of H₂SO₄ (ACS, sp. gr. 1.84) to 50 mL of reagent water.

6.7 Sulfuric acid (1 M)—Slowly, add 58 mL of H₂SO₄ (ACS, sp. gr. 1.84) to reagent water and dilute to 1 L.

6.8 Acetate buffer (0.1 M, pH 4.7)—Dissolve 5.8 mL of glacial acetic acid (ACS) and 13.6 g of sodium acetate trihydrate (ACS) in reagent water which has been purified by filtration through a RO-4 Millipore System or equivalent and dilute to 1 L.

6.9 Acetonitrile, chloroform (preserved with 1% ethanol), methanol—Pesticide quality or equivalent.

6.10 Mobile phase—Place equal volumes of filtered acetonitrile (Millipore type FH filter or equivalent) and filtered acetate buffer (Millipore type GS filter or equivalent) in a narrow-mouth, glass container and mix thoroughly. Prepare fresh weekly. Degas daily by sonicating under vacuum, by heating and stirring, or by purging with helium.

6.11 Stock standard solutions (1.00 µg/µL)—Stock standard solutions may be prepared from pure standard materials or purchased as certified solutions.

6.11.1 Prepare stock standard solutions by accurately weighing about 0.0100 g of pure material. Dissolve the material in methanol and dilute to volume in a 10-mL volumetric flask. Larger volumes can be used at the convenience of the analyst. When compound purity is assayed to be 96% or greater, the weight can be used without correction to calculate the concentration of the stock standard. Commercially prepared stock standards can be used at any concentration if they are certified by the manufacturer or by an independent source.

6.11.2 Transfer the stock standard solutions into Teflon-sealed screw-cap bottles. Store at 4 °C and protect from light. Stock standard solutions should be checked frequently for signs of degradation or evaporation, especially just prior to preparing calibration standards from them.

6.11.3 Stock standard solutions must be replaced after six months, or sooner if comparison with check standards indicates a problem.

6.12 Quality control check sample concentrate—See Section 8.2.1.

7. Calibration

7.1 Establish chromatographic operating conditions equivalent to those given in Table 1. The HPLC system can be calibrated using the external standard technique (Section 7.2) or the internal standard technique (Section 7.3).

7.2 External standard calibration procedure:

7.2.1 Prepare calibration standards at a minimum of three concentration levels for each parameter of interest by adding volumes of one or more stock standards to a volumetric flask and diluting to volume with mobile phase. One of the external standards should be at a concentration near, but above, the MDL (Table 1) and the other concentrations should correspond to the expected range of concentrations found in real samples or should define the working range of the detector.

7.2.2 Using syringe injections of 5 to 25 μL or a constant volume injection loop, analyze each calibration standard according to Section 12 and tabulate peak height or area responses against the mass injected. The results can be used to prepare a calibration curve for each compound. Alternatively, if the ratio of response to amount injected (calibration factor) is a constant over the working range (<10% relative standard deviation, RSD), linearity through the origin can be assumed and the average ratio or calibration factor can be used in place of a calibration curve.

7.3 Internal standard calibration procedure—To use this approach, the analyst must select one or more internal standards that are similar in analytical behavior to the compounds of interest. The analyst must further demonstrate that the measurement of the internal standard is not affected by method or matrix interferences. Because of these limitations, no internal standard can be suggested that is applicable to all samples.

7.3.1 Prepare calibration standards at a minimum of three concentration levels for each parameter of interest by adding volumes of one or more stock standards to a volumetric flask. To each calibration standard, add a known constant amount of one or more internal standards, and dilute to volume with mobile phase. One of the standards should be at a concentration near, but above, the MDL and the other concentrations should correspond to the expected range of concentrations found in real samples or should define the working range of the detector.

7.3.2 Using syringe injections of 5 to 25 μL or a constant volume injection loop, analyze each calibration standard according to Section 12 and tabulate peak height or area responses against concentration for each compound and internal standard. Calculate re-

sponse factors (RF) for each compound using Equation 1.

$$\text{RF} = (A_s)(C_{is}) / (A_{is})(C_s) \quad \text{Equation 1}$$

where:

A_s = Response for the parameter to be measured.

A_{is} = Response for the internal standard.

C_{is} = Concentration of the internal standard ($\mu\text{g/L}$).

C_s = Concentration of the parameter to be measured ($\mu\text{g/L}$).

If the RF value over the working range is a constant (<10% RSD), the RF can be assumed to be invariant and the average RF can be used for calculations. Alternatively, the results can be used to plot a calibration curve of response ratios, A_s/A_{is} , vs. RF.

7.4 The working calibration curve, calibration factor, or RF must be verified on each working day by the measurement of one or more calibration standards. If the response for any parameter varies from the predicted response by more than $\pm 15\%$, a new calibration curve must be prepared for that compound. If serious loss of response occurs, polish the electrode and recalibrate.

7.5 Before using any cleanup procedure, the analyst must process a series of calibration standards through the procedure to validate elution patterns and the absence of interferences from the reagents.

8. Quality Control

8.1 Each laboratory that uses this method is required to operate a formal quality control program. The minimum requirements of this program consist of an initial demonstration of laboratory capability and an ongoing analysis of spiked samples to evaluate and document data quality. The laboratory must maintain records to document the quality of data that is generated. Ongoing data quality checks are compared with established performance criteria to determine if the results of analyses meet the performance characteristics of the method. When results of sample spikes indicate atypical method performance, a quality control check standard must be analyzed to confirm that the measurements were performed in an in-control mode of operation.

8.1.1 The analyst must make an initial, one-time, demonstration of the ability to generate acceptable accuracy and precision with this method. This ability is established as described in Section 8.2.

8.1.2 In recognition of advances that are occurring in chromatography, the analyst is permitted certain options (detailed in Sections 10.9, 11.1, and 12.1) to improve the separations or lower the cost of measurements. Each time such a modification is made to the method, the analyst is required to repeat the procedure in Section 8.2.

8.1.3 Before processing any samples, the analyst must analyze a reagent water blank to demonstrate that interferences from the analytical system and glassware are under control. Each time a set of samples is extracted or reagents are changed, a reagent water blank must be processed as a safeguard against laboratory contamination.

8.1.4 The laboratory must, on an ongoing basis, spike and analyze a minimum of 10% of all samples to monitor and evaluate laboratory data quality. This procedure is described in Section 8.3.

8.1.5 The laboratory must, on an ongoing basis, demonstrate through the analyses of quality control check standards that the operation of the measurement system is in control. This procedure is described in Section 8.4. The frequency of the check standard analyses is equivalent to 10% of all samples analyzed but may be reduced if spike recoveries from samples (Section 8.3) meet all specified quality control criteria.

8.1.6 The laboratory must maintain performance records to document the quality of data that is generated. This procedure is described in Section 8.5.

8.2 To establish the ability to generate acceptable accuracy and precision, the analyst must perform the following operations.

8.2.1 A quality control (QC) check sample concentrate is required containing benzidine and/or 3,3'-dichlorobenzidine at a concentration of 50 µg/mL each in methanol. The QC check sample concentrate must be obtained from the U.S. Environmental Protection Agency, Environmental Monitoring and Support Laboratory in Cincinnati, Ohio, if available. If not available from that source, the QC check sample concentrate must be obtained from another external source. If not available from either source above, the QC check sample concentrate must be prepared by the laboratory using stock standards prepared independently from those used for calibration.

8.2.2 Using a pipet, prepare QC check samples at a concentration of 50 µg/L by adding 1.00 mL of QC check sample concentrate to each of four 1-L-L aliquots of reagent water.

8.2.3 Analyze the well-mixed QC check samples according to the method beginning in Section 10.

8.2.4 Calculate the average recovery (\bar{X}) in µg/L, and the standard deviation of the recovery (s) in µg/L, for each parameter using the four results.

8.2.5 For each parameter compare s and \bar{X} with the corresponding acceptance criteria for precision and accuracy, respectively, found in Table 2. If s and \bar{X} for all parameters of interest meet the acceptance criteria, the system performance is acceptable and analysis of actual samples can begin. If any individual s exceeds the precision limit or any individual \bar{X} falls outside the range for accuracy, the system performance is un-

acceptable for that parameter. Locate and correct the source of the problem and repeat the test for all parameters of interest beginning with Section 8.2.2.

8.3 The laboratory must, on an ongoing basis, spike at least 10% of the samples from each sample site being monitored to assess accuracy. For laboratories analyzing one to ten samples per month, at least one spiked sample per month is required.

8.3.1 The concentration of the spike in the sample should be determined as follows:

8.3.1.1 If, as in compliance monitoring, the concentration of a specific parameter in the sample is being checked against a regulatory concentration limit, the spike should be at that limit or 1 to 5 times higher than the background concentration determined in Section 8.3.2, whichever concentration would be larger.

8.3.1.2 If the concentration of a specific parameter in the sample is not being checked against a limit specific to that parameter, the spike should be at 50 µg/L or 1 to 5 times higher than the background concentration determined in Section 8.3.2, whichever concentration would be larger.

8.3.1.3 If it is impractical to determine background levels before spiking (e.g., maximum holding times will be exceeded), the spike concentration should be (1) the regulatory concentration limit, if any; or, if none (2) the larger of either 5 times higher than the expected background concentration or 50 µg/L.

8.3.2 Analyze one sample aliquot to determine the background concentration (B) of each parameter. If necessary, prepare a new QC check sample concentrate (Section 8.2.1) appropriate for the background concentrations in the sample. Spike a second sample aliquot with 1.0 mL of the QC check sample concentrate and analyze it to determine the concentration after spiking (A) of each parameter. Calculate each percent recovery (P) as $100(A-B)/T$, where T is the known true value of the spike.

8.3.3 Compare the percent recovery (P) for each parameter with the corresponding QC acceptance criteria found in Table 2. These acceptance criteria were calculated to include an allowance for error in measurement of both the background and spike concentrations, assuming a spike to background ratio of 5:1. This error will be accounted for to the extent that the analyst's spike to background ratio approaches 5:1.⁷ If spiking was performed at a concentration lower than 50 µg/L, the analyst must use either the QC acceptance criteria in Table 2, or optional QC acceptance criteria calculated for the specific spike concentration. To calculate optional acceptance criteria for the recovery of a parameter: (1) Calculate accuracy (X') using the equation in Table 3, substituting

the spike concentration (T) for C; (2) calculate overall precision (S') using the equation in Table 3, substituting X' for \bar{X} ; (3) calculate the range for recovery at the spike concentration as $(100 X'/T) \pm 2.44(100 S'/T)\%$.⁷

8.3.4 If any individual P falls outside the designated range for recovery, that parameter has failed the acceptance criteria. A check standard containing each parameter that failed the criteria must be analyzed as described in Section 8.4.

8.4 If any parameter fails the acceptance criteria for recovery in Section 8.3, a QC check standard containing each parameter that failed must be prepared and analyzed.

NOTE: The frequency for the required analysis of a QC check standard will depend upon the number of parameters being simultaneously tested, the complexity of the sample matrix, and the performance of the laboratory.

8.4.1 Prepare the QC check standard by adding 1.0 mL of QC check sample concentrate (Sections 8.2.1 or 8.3.2) to 1 L of reagent water. The QC check standard needs only to contain the parameters that failed criteria in the test in Section 8.3.

8.4.2 Analyze the QC check standard to determine the concentration measured (A) of each parameter. Calculate each percent recovery (P_s) as $100 (A/T)\%$, where T is the true value of the standard concentration.

8.4.3 Compare the percent recovery (P_s) for each parameter with the corresponding QC acceptance criteria found in Table 2. Only parameters that failed the test in Section 8.3 need to be compared with these criteria. If the recovery of any such parameter falls outside the designated range, the laboratory performance for that parameter is judged to be out of control, and the problem must be immediately identified and corrected. The analytical result for that parameter in the unspiked sample is suspect and may not be reported for regulatory compliance purposes.

8.5 As part of the QC program for the laboratory, method accuracy for wastewater samples must be assessed and records must be maintained. After the analysis of five spiked wastewater samples as in Section 8.3, calculate the average percent recovery (\bar{P}) and the standard deviation of the percent recovery (s_p). Express the accuracy assessment as a percent recovery interval from $\bar{P} - 2s_p$ to $\bar{P} + 2s_p$. If $\bar{P}=90\%$ and $s_p=10\%$, for example, the accuracy interval is expressed as 70–110%. Update the accuracy assessment for each parameter on a regular basis (e.g. after each five to ten new accuracy measurements).

8.6 It is recommended that the laboratory adopt additional quality assurance practices for use with this method. The specific practices that are most productive depend upon the needs of the laboratory and the nature of the samples. Field duplicates may be analyzed to assess the precision of the environmental measurements. When doubt exists

over the identification of a peak on the chromatogram, confirmatory techniques such as HPLC with a dissimilar column, gas chromatography, or mass spectrometer must be used. Whenever possible, the laboratory should analyze standard reference materials and participate in relevant performance evaluation studies.

9. Sample Collection, Preservation, and Handling

9.1 Grab samples must be collected in glass containers. Conventional sampling practices⁸ should be followed, except that the bottle must not be prerinsed with sample before collection. Composite samples should be collected in refrigerated glass containers in accordance with the requirements of the program. Automatic sampling equipment must be as free as possible of Tygon tubing and other potential sources of contamination.

9.2 All samples must be iced or refrigerated at 4°C and stored in the dark from the time of collection until extraction. Both benzidine and 3,3'-dichlorobenzidine are easily oxidized. Fill the sample bottles and, if residual chlorine is present, add 80 mg of sodium thiosulfate per liter of sample and mix well. EPA Methods 330.4 and 330.5 may be used for measurement of residual chlorine.⁹ Field test kits are available for this purpose. After mixing, adjust the pH of the sample to a range of 2 to 7 with sulfuric acid.

9.3 If 1,2-diphenylhydrazine is likely to be present, adjust the pH of the sample to 4.0 \pm 0.2 to prevent rearrangement to benzidine.

9.4 All samples must be extracted within 7 days of collection. Extracts may be held up to 7 days before analysis, if stored under an inert (oxidant free) atmosphere.² The extract should be protected from light.

10. Sample Extraction

10.1 Mark the water meniscus on the side of the sample bottle for later determination of sample volume. Pour the entire sample into a 2-L separatory funnel. Check the pH of the sample with wide-range pH paper and adjust to within the range of 6.5 to 7.5 with sodium hydroxide solution or sulfuric acid.

10.2 Add 100 mL of chloroform to the sample bottle, seal, and shake 30 s to rinse the inner surface. (Caution: Handle chloroform in a well ventilated area.) Transfer the solvent to the separatory funnel and extract the sample by shaking the funnel for 2 min with periodic venting to release excess pressure. Allow the organic layer to separate from the water phase for a minimum of 10 min. If the emulsion interface between layers is more than one-third the volume of the solvent layer, the analyst must employ mechanical techniques to complete the phase separation. The optimum technique depends upon the sample, but may include stirring,

filtration of the emulsion through glass wool, centrifugation, or other physical methods. Collect the chloroform extract in a 250-mL separatory funnel.

10.3 Add a 50-mL volume of chloroform to the sample bottle and repeat the extraction procedure a second time, combining the extracts in the separatory funnel. Perform a third extraction in the same manner.

10.4 Separate and discard any aqueous layer remaining in the 250-mL separatory funnel after combining the organic extracts. Add 25 mL of 1 M sulfuric acid and extract the sample by shaking the funnel for 2 min. Transfer the aqueous layer to a 250-mL beaker. Extract with two additional 25-mL portions of 1 M sulfuric acid and combine the acid extracts in the beaker.

10.5 Place a stirbar in the 250-mL beaker and stir the acid extract while carefully adding 5 mL of 0.4 M sodium tribasic phosphate. While monitoring with a pH meter, neutralize the extract to a pH between 6 and 7 by dropwise addition of 5 N sodium hydroxide solution while stirring the solution vigorously. Approximately 25 to 30 mL of 5 N sodium hydroxide solution will be required and it should be added over at least a 2-min period. Do not allow the sample pH to exceed 8.

10.6 Transfer the neutralized extract into a 250-mL separatory funnel. Add 30 mL of chloroform and shake the funnel for 2 min. Allow the phases to separate, and transfer the organic layer to a second 250-mL separatory funnel.

10.7 Extract the aqueous layer with two additional 20-mL aliquots of chloroform as before. Combine the extracts in the 250-mL separatory funnel.

10.8 Add 20 mL of reagent water to the combined organic layers and shake for 30 s.

10.9 Transfer the organic extract into a 100-mL round bottom flask. Add 20 mL of methanol and concentrate to 5 mL with a rotary evaporator at reduced pressure and 35 °C. An aspirator is recommended for use as the source of vacuum. Chill the receiver with ice. This operation requires approximately 10 min. Other concentration techniques may be used if the requirements of Section 8.2 are met.

10.10 Using a 9-in. Pasteur pipette, transfer the extract to a 15-mL, conical, screw-cap centrifuge tube. Rinse the flask, including the entire side wall, with 2-mL portions of methanol and combine with the original extract.

10.11 Carefully concentrate the extract to 0.5 mL using a gentle stream of nitrogen while heating in a 30 °C water bath. Dilute to 2 mL with methanol, reconcentrate to 1 mL, and dilute to 5 mL with acetate buffer. Mix the extract thoroughly. Cap the centrifuge tube and store refrigerated and protected from light if further processing will not be performed immediately. If the extract will be stored longer than two days, it should be

transferred to a Teflon-sealed screw-cap vial. If the sample extract requires no further cleanup, proceed with HPLC analysis (Section 12). If the sample requires further cleanup, proceed to Section 11.

10.12 Determine the original sample volume by refilling the sample bottle to the mark and transferring the liquid to a 1,000-mL graduated cylinder. Record the sample volume to the nearest 5 mL.

11. Cleanup and Separation

11.1 Cleanup procedures may not be necessary for a relatively clean sample matrix. If particular circumstances demand the use of a cleanup procedure, the analyst first must demonstrate that the requirements of Section 8.2 can be met using the method as revised to incorporate the cleanup procedure.

12. High Performance Liquid Chromatography

12.1 Table 1 summarizes the recommended operating conditions for the HPLC. Included in this table are retention times, capacity factors, and MDL that can be achieved under these conditions. An example of the separations achieved by this HPLC column is shown in Figure 1. Other HPLC columns, chromatographic conditions, or detectors may be used if the requirements of Section 8.2 are met. When the HPLC is idle, it is advisable to maintain a 0.1 mL/min flow through the column to prolong column life.

12.2 Calibrate the system daily as described in Section 7.

12.3 If the internal standard calibration procedure is being used, the internal standard must be added to the sample extract and mixed thoroughly immediately before injection into the instrument.

12.4 Inject 5 to 25 µL of the sample extract or standard into the HPLC. If constant volume injection loops are not used, record the volume injected to the nearest 0.05 µL, and the resulting peak size in area or peak height units.

12.5 Identify the parameters in the sample by comparing the retention times of the peaks in the sample chromatogram with those of the peaks in standard chromatograms. The width of the retention time window used to make identifications should be based upon measurements of actual retention time variations of standards over the course of a day. Three times the standard deviation of a retention time for a compound can be used to calculate a suggested window size; however, the experience of the analyst should weigh heavily in the interpretation of chromatograms.

12.6 If the response for a peak exceeds the working range of the system, dilute the extract with mobile phase and reanalyze.

12.7 If the measurement of the peak response for benzidine is prevented by the presence of interferences, reduce the electrode potential to +0.6 V and reanalyze. If the benzidine peak is still obscured by interferences, further cleanup is required.

13. Calculations

13.1 Determine the concentration of individual compounds in the sample.

13.1.1 If the external standard calibration procedure is used, calculate the amount of material injected from the peak response using the calibration curve or calibration factor determined in Section 7.2.2. The concentration in the sample can be calculated from Equation 2.

$$\text{Concentration } (\mu\text{g/L}) = \frac{(A)(V_t)}{(V_i)(V_s)}$$

Equation 2

where:

A=Amount of material injected (ng).

V_t=Volume of extract injected (μL).

V_i=Volume of total extract (μL).

V_s=Volume of water extracted (mL).

13.1.2 If the internal standard calibration procedure is used, calculate the concentration in the sample using the response factor (RF) determined in Section 7.3.2 and Equation 3.

$$\text{Concentration } (\mu\text{g/L}) = \frac{(A_s)(I_s)}{(A_{is})(RF)(V_o)}$$

Equation 3

where:

A_s=Response for the parameter to be measured.

A_{is}=Response for the internal standard.

I_s=Amount of internal standard added to each extract (μg).

V_o=Volume of water extracted (L).

13.2 Report results in μg/L without correction for recovery data. All QC data obtained should be reported with the sample results.

14. Method Performance

14.1 The method detection limit (MDL) is defined as the minimum concentration of a substance that can be measured and reported with 99% confidence that the value is above zero.¹ The MDL concentrations listed in Table 1 were obtained using reagent water.¹⁰ Similar results were achieved using representative wastewaters. The MDL actually achieved in a given analysis will vary depending on instrument sensitivity and matrix effects.

14.2 This method has been tested for linearity of spike recovery from reagent water and has been demonstrated to be applicable

over the concentration range from 7×MDL to 3000×MDL.¹⁰

14.3 This method was tested by 17 laboratories using reagent water, drinking water, surface water, and three industrial wastewaters spiked at six concentrations over the range 1.0 to 70 μg/L.¹¹ Single operator precision, overall precision, and method accuracy were found to be directly related to the concentration of the parameter and essentially independent of the sample matrix. Linear equations to describe these relationships are presented in Table 3.

References

- 40 CFR part 136, appendix B.
- "Determination of Benzidines in Industrial and Municipal Wastewaters," EPA 600/4-82-022, National Technical Information Service, PB82-196320, Springfield, Virginia 22161, April 1982.
- ASTM Annual Book of Standards, Part 31, D3694-78. "Standard Practices for Preparation of Sample Containers and for Preservation of Organic Constituents," American Society for Testing and Materials, Philadelphia.
- "Carcinogens—Working With Carcinogens," Department of Health, Education, and Welfare, Public Health Service, Center for Disease Control, National Institute for Occupational Safety and Health, Publication No. 77-206, August 1977.
- "OSHA Safety and Health Standards, General Industry," (29 CFR part 1910), Occupational Safety and Health Administration, OSHA 2206 (Revised, January 1976).
- "Safety in Academic Chemistry Laboratories," American Chemical Society Publication, Committee on Chemical Safety, 3rd Edition, 1979.
- Provost, L.P., and Elder, R.S. "Interpretation of Percent Recovery Data," *American Laboratory*, 15, 58-63 (1983). (The value 2.44 used in the equation in Section 8.3.3 is two times the value 1.22 derived in this report.)
- ASTM Annual Book of Standards, Part 31, D3370-76. "Standard Practices for Sampling Water," American Society for Testing and Materials, Philadelphia.
- "Methods 330.4 (Titrimetric, DPD-FAS) and 330.5 (Spectrophotometric, DPD) for Chlorine Total Residual," Methods for Chemical Analysis of Water and Wastes, EPA-600/4-79-020, U.S. Environmental Protection Agency, Environmental Monitoring and Support Laboratory, Cincinnati, Ohio 45268, March 1979.
- "EPA Method Study 15, Method 605 (Benzidines)," EPA 600/4-84-062, National Technical Information Service, PB84-211176, Springfield, Virginia 22161, June 1984.
- "EPA Method Validation Study 15, Method 605 (Benzidines)," Report for EPA Contract 68-03-2624 (In preparation).

TABLE 1—CHROMATOGRAPHIC CONDITIONS AND METHOD DETECTION LIMITS

| Parameter | Retention time (min) | Column capacity factor (k') | Method detection limit (µg/L) |
|------------------------------|----------------------|-----------------------------|-------------------------------|
| Benzidine | 6.1 | 1.44 | 0.08 |
| 3,3'-Dichlorobenzidine | 12.1 | 3.84 | 0.13 |

HPLC Column conditions: Lichrosorb RP-2, 5 micron particle size, in a 25 cm×4.6 mm ID stainless steel column. Mobile Phase: 0.8 mL/min of 50% acetonitrile/50% 0.1M pH 4.7 acetate buffer. The MDL were determined using an electrochemical detector operated at +0.8 V.

TABLE 2—QC ACCEPTANCE CRITERIA—METHOD 605

| Parameter | Test conc. (µg/L) | Limit for s (µg/L) | Range for X (µg/L) | Range for P _i , P _s (percent) |
|------------------------------|-------------------|--------------------|--------------------|---|
| Benzidine | 50 | 18.7 | 9.1–61.0 | D–140 |
| 3,3'-Dichlorobenzidine | 50 | 23.6 | 18.7–50.0 | 5–128 |

s=Standard deviation of four recovery measurements, in µg/L (Section 8.2.4).

X=Average recovery for four recovery measurements, in µg/L (Section 8.2.4).

P_i, P_s=Percent recovery measured (Section 8.3.2, Section 8.4.2).

D=Detected; result must be greater than zero.

Note: These criteria are based directly upon the method performance data in Table 3. Where necessary, the limits for recovery have been broadened to assure applicability of the limits to concentrations below those used to develop Table 3.

TABLE 3—METHOD ACCURACY AND PRECISION AS FUNCTIONS OF CONCENTRATION—METHOD 605

| Parameter | Accuracy, as recovery, X' (µg/L) | Single analyst precision, s _r ' (µg/L) | Overall precision, S' (µg/L) |
|------------------------------|----------------------------------|---|------------------------------|
| Benzidine | 0.70C+0.06 | 0.28X̄+0.19 | 0.40X̄+0.18 |
| 3,3'-Dichlorobenzidine | 0.66C+0.23 | 0.39X̄–0.05 | 0.38X̄+0.02 |

X'=Expected recovery for one or more measurements of a sample containing a concentration of C, in µg/L.

s_r'=Expected single analyst standard deviation of measurements at an average concentration found of X̄, in µg/L.

S'=Expected interlaboratory standard deviation of measurements at an average concentration found of X̄, in µg/L.

C=True value for the concentration, in µg/L.

X̄=Average recovery found for measurements of samples containing a concentration of C, in µg/L.

COLUMN: LICHROSORB RP-2
MOBILE PHASE: 50% ACETONITRILE IN ACETATE BUFFER
DETECTOR: ELECTROCHEMICAL AT + 0.8 V

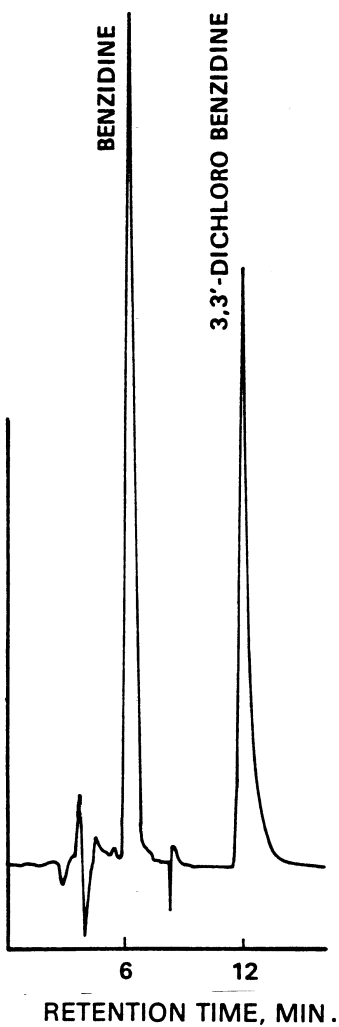

Figure 1. Liquid chromatogram of benzidines.

METHOD 606—PHTHALATE ESTER

1. Scope and Application

1.1 This method covers the determination of certain phthalate esters. The following parameters can be determined by this method:

| Parameter | STORET No. | CAS No. |
|-----------------------------------|------------|----------|
| Bis(2-ethylhexyl) phthalate | 39100 | 117-81-7 |
| Butyl benzyl phthalate | 34292 | 85-68-7 |
| Di-n-butyl phthalate | 39110 | 84-74-2 |
| Diethyl phthalate | 34336 | 84-66-2 |
| Dimethyl phthalate | 34341 | 131-11-3 |
| Di-n-octyl phthalate | 34596 | 117-84-0 |

1.2 This is a gas chromatographic (GC) method applicable to the determination of the compounds listed above in municipal and industrial discharges as provided under 40 CFR 136.1. When this method is used to analyze unfamiliar samples for any or all of the compounds above, compound identifications should be supported by at least one additional qualitative technique. This method describes analytical conditions for a second gas chromatographic column that can be used to confirm measurements made with the primary column. Method 625 provides gas chromatograph/mass spectrometer (GC/MS) conditions appropriate for the qualitative and quantitative confirmation of results for all of the parameters listed above, using the extract produced by this method.

1.3 The method detection limit (MDL, defined in Section 14.1)¹ for each parameter is listed in Table 1. The MDL for a specific wastewater may differ from those listed, depending upon the nature of interferences in the sample matrix.

1.4 The sample extraction and concentration steps in this method are essentially the same as in Methods 608, 609, 611, and 612. Thus, a single sample may be extracted to measure the parameters included in the scope of each of these methods. When cleanup is required, the concentration levels must be high enough to permit selecting aliquots, as necessary, to apply appropriate cleanup procedures. The analyst is allowed the latitude, under Section 12, to select chromatographic conditions appropriate for the simultaneous measurement of combinations of these parameters.

1.5 Any modification of this method, beyond those expressly permitted, shall be considered as a major modification subject to application and approval of alternate test procedures under 40 CFR 136.4 and 136.5.

1.6 This method is restricted to use by or under the supervision of analysts experienced in the use of a gas chromatograph and in the interpretation of gas chromatograms. Each analyst must demonstrate the ability to generate acceptable results with this method using the procedure described in Section 8.2.

2. Summary of Method

2.1 A measured volume of sample, approximately 1-L, is extracted with methylene chloride using a separatory funnel. The methylene chloride extract is dried and exchanged to hexane during concentration to a volume of 10 mL or less. The extract is separated by gas chromatography and the phthalate esters are then measured with an electron capture detector.²

2.2 Analysis for phthalates is especially complicated by their ubiquitous occurrence in the environment. The method provides Florisil and alumina column cleanup procedures to aid in the elimination of interferences that may be encountered.

3. Interferences

3.1 Method interferences may be caused by contaminants in solvents, reagents, glassware, and other sample processing hardware that lead to discrete artifacts and/or elevated baselines in gas chromatograms. All of these materials must be routinely demonstrated to be free from interferences under the conditions of the analysis by running laboratory reagent blanks as described in Section 8.1.3.

3.1.1 Glassware must be scrupulously cleaned.³ Clean all glassware as soon as possible after use by rinsing with the last solvent used in it. Solvent rinsing should be followed by detergent washing with hot water, and rinses with tap water and distilled water. The glassware should then be drained dry, and heated in a muffle furnace at 400 °C for 15 to 30 min. Some thermally stable materials, such as PCBs, may not be eliminated by this treatment. Solvent rinses with acetone and pesticide quality hexane may be substituted for the muffle furnace heating. Thorough rinsing with such solvents usually eliminates PCB interference. Volumetric ware should not be heated in a muffle furnace. After drying and cooling, glassware should be sealed and stored in a clean environment to prevent any accumulation of dust or other contaminants. Store inverted or capped with aluminum foil.

3.1.2 The use of high purity reagents and solvents helps to minimize interference problems. Purification of solvents by distillation in all-glass systems may be required.

3.2 Phthalate esters are contaminants in many products commonly found in the laboratory. It is particularly important to avoid the use of plastics because phthalates are commonly used as plasticizers and are easily extracted from plastic materials. Serious phthalate contamination can result at any time, if consistent quality control is not practiced. Great care must be experienced to prevent such contamination. Exhaustive cleanup of reagents and glassware may be required to eliminate background phthalate contamination.^{4,5}

3.3 Matrix interferences may be caused by contaminants that are co-extracted from the sample. The extent of matrix interferences will vary considerably from source to source, depending upon the nature and diversity of the industrial complex or municipality being sampled. The cleanup procedures in Section 11 can be used to overcome many of these interferences, but unique samples may require additional cleanup approaches to achieve the MDL listed in Table 1.

4. Safety

4.1 The toxicity or carcinogenicity of each reagent used in this method has not been precisely defined; however, each chemical compound should be treated as a potential health hazard. From this viewpoint, exposure to these chemicals must be reduced to the lowest possible level by whatever means available. The laboratory is responsible for maintaining a current awareness file of OSHA regulations regarding the safe handling of the chemicals specified in this method. A reference file of material data handling sheets should also be made available to all personnel involved in the chemical analysis. Additional references to laboratory safety are available and have been identified^{6,8} for the information of the analyst.

5. Apparatus and Materials

5.1 Sampling equipment, for discrete or composite sampling.

5.1.1 Grab sample bottle—1-L or 1-qt, amber glass, fitted with a screw cap lined with Teflon. Foil may be substituted for Teflon if the sample is not corrosive. If amber bottles are not available, protect samples from light. The bottle and cap liner must be washed, rinsed with acetone or methylene chloride, and dried before use to minimize contamination.

5.1.2 Automatic sampler (optional)—The sampler must incorporate glass sample containers for the collection of a minimum of 250 mL of sample. Sample containers must be kept refrigerated at 4 °C and protected from light during compositing. If the sampler uses a peristaltic pump, a minimum length of compressible silicone rubber tubing may be used. Before use, however, the compressible tubing should be thoroughly rinsed with methanol, followed by repeated rinsings with distilled water to minimize the potential for contamination of the sample. An integrating flow meter is required to collect flow proportional composites.

5.2 Glassware (All specifications are suggested. Catalog numbers are included for illustration only).

5.2.1 Separatory funnel—2-L, with Teflon stopcock.

5.2.2 Drying column—Chromatographic column, approximately 400 mm long × 19 mm ID, with coarse frit filter disc.

5.2.3 Chromatographic column—300 mm long × 10 mm ID, with Teflon stopcock and coarse frit filter disc at bottom (Kontes K-420540-0213 or equivalent).

5.2.4 Concentrator tube, Kuderna-Danish—10-mL, graduated (Kontes K-570050-1025 or equivalent). Calibration must be checked at the volumes employed in the test. Ground glass stopper is used to prevent evaporation of extracts.

5.2.5 Evaporative flask, Kuderna-Danish—500-mL (Kontes K-570001-0500 or equivalent). Attach to concentrator tube with springs.

5.2.6 Snyder column, Kuderna-Danish—Three-ball macro (Kontes K-503000-0121 or equivalent).

5.2.7 Snyder column, Kuderna-Danish—Two-ball micro (Kontes K-569001-0219 or equivalent).

5.2.8 Vials—10 to 15-mL, amber glass, with Teflon-lined screw cap.

5.3 Boiling chips—Approximately 10/40 mesh. Heat to 400 °C for 30 min or Soxhlet extract with methylene chloride.

5.4 Water bath—Heated, with concentric ring cover, capable of temperature control (± 2 °C). The bath should be used in a hood.

5.5 Balance—Analytical, capable of accurately weighing 0.0001 g.

5.6 Gas chromatograph—An analytical system complete with gas chromatograph suitable for on-column injection and all required accessories including syringes, analytical columns, gases, detector, and strip-chart recorder. A data system is recommended for measuring peak areas.

5.6.1 Column 1—1.8 m long × 4 mm ID glass, packed with 1.5% SP-2250/1.95% SP-2401 Supelcoport (100/120 mesh) or equivalent. This column was used to develop the method performance statements in Section 14. Guidelines for the use of alternate column packings are provided in Section 12.1.

5.6.2 Column 2—1.8 m long × 4 mm ID glass, packed with 3% OV-1 on Supelcoport (100/120 mesh) or equivalent.

5.6.3 Detector—Electron capture detector. This detector has proven effective in the analysis of wastewaters for the parameters listed in the scope (Section 1.1), and was used to develop the method performance statements in Section 14. Guidelines for the use of alternate detectors are provided in Section 12.1.

6. Reagents

6.1 Reagent water—Reagent water is defined as a water in which an interferent is not observed at the MDL of the parameters of interest.

6.2 Acetone, hexane, isooctane, methylene chloride, methanol—Pesticide quality or equivalent.

6.3 Ethyl ether—nanograde, redistilled in glass if necessary.

6.3.1 Ethyl ether must be shown to be free of peroxides before it is used as indicated by

EM Laboratories Quant test strips. (Available from Scientific Products Co., Cat. No. P1126-8, and other suppliers.)

6.3.2 Procedures recommended for removal of peroxides are provided with the test strips. After cleanup, 20 mL of ethyl alcohol preservative must be added to each liter of ether.

6.4 Sodium sulfate—(ACS) Granular, anhydrous. Several levels of purification may be required in order to reduce background phthalate levels to an acceptable level: 1) Heat 4 h at 400 °C in a shallow tray, 2) Heat 16 h at 450 to 500 °C in a shallow tray, 3) Soxhlet extract with methylene chloride for 48 h.

6.5 Florisil—PR grade (60/100 mesh). Purchase activated at 1250 °F and store in the dark in glass containers with ground glass stoppers or foil-lined screw caps. To prepare for use, place 100 g of Florisil into a 500-mL beaker and heat for approximately 16 h at 40 °C. After heating transfer to a 500-mL reagent bottle. Tightly seal and cool to room temperature. When cool add 3 mL of reagent water. Mix thoroughly by shaking or rolling for 10 min and let it stand for at least 2 h. Keep the bottle sealed tightly.

6.6 Alumina—Neutral activity Super I, W200 series (ICN Life Sciences Group, No. 404583). To prepare for use, place 100 g of alumina into a 500-mL beaker and heat for approximately 16 h at 400 °C. After heating transfer to a 500-mL reagent bottle. Tightly seal and cool to room temperature. When cool add 3 mL of reagent water. Mix thoroughly by shaking or rolling for 10 min and let it stand for at least 2 h. Keep the bottle sealed tightly.

6.7 Stock standard solutions (1.00 µg/µL)—Stock standard solutions can be prepared from pure standard materials or purchased as certified solutions.

6.7.1 Prepare stock standard solutions by accurately weighing about 0.0100 g of pure material. Dissolve the material in isooctane and dilute to volume in a 10-mL volumetric flask. Larger volumes can be used at the convenience of the analyst. When compound purity is assayed to be 96% or greater, the weight can be used without correction to calculate the concentration of the stock standard. Commercially prepared stock standards can be used at any concentration if they are certified by the manufacturer or by an independent source.

6.7.2 Transfer the stock standard solutions into Teflon-sealed screw-cap bottles. Store at 4 °C and protect from light. Stock standard solutions should be checked frequently for signs of degradation or evaporation, especially just prior to preparing calibration standards from them.

6.7.3 Stock standard solutions must be replaced after six months, or sooner if comparison with check standards indicates a problem.

6.8 Quality control check sample concentrate—See Section 8.2.1.

7. Calibration

7.1 Establish gas chromatograph operating conditions equivalent to those given in Table 1. The gas chromatographic system can be calibrated using the external standard technique (Section 7.2) or the internal standard technique (Section 7.3).

7.2 External standard calibration procedure:

7.2.1 Prepared calibration standards at a minimum of three concentration levels for each parameter of interest by adding volumes of one or more stock standards to a volumetric flask and diluting to volume with isooctane. One of the external standards should be at a concentration near, but above, the MDL (Table 1) and the other concentrations should correspond to the expected range of concentrations found in real samples or should define the working range of the detector.

7.2.2 Using injections of 2 to 5 µL, analyze each calibration standard according to Section 12 and tabulate peak height or area responses against the mass injected. The results can be used to prepare a calibration curve for each compound. Alternatively, if the ratio of response to amount injected (calibration factor) is a constant over the working range (<10% relative standard deviation, RSD), linearity through the origin can be assumed and the average ratio or calibration factor can be used in place of a calibration curve.

7.3 Internal standard calibration procedure—To use this approach, the analyst must select one or more internal standards that are similar in analytical behavior to the compounds of interest. The analyst must further demonstrate that the measurement of the internal standard is not affected by method or matrix interferences. Because of these limitations, no internal standard can be suggested that is applicable to all samples.

7.3.1 Prepare calibration standards at a minimum of three concentration levels for each parameter of interest by adding volumes of one or more stock standards to a volumetric flask. To each calibration standard, add a known constant amount of one or more internal standards, and dilute to volume with isooctane. One of the standards should be at a concentration near, but above, the MDL and the other concentrations should correspond to the expected range of concentrations found in real samples or should define the working range of the detector.

7.3.2 Using injections of 2 to 5 μL , analyze each calibration standard according to Section 12 and tabulate peak height or area responses against concentration for each compound and internal standard. Calculate response factors (RF) for each compound using Equation 1.

$$\text{RF} = (A_s)(C_{is}) / (A_{is})(C_s)$$

Equation 1

where:

A_s = Response for the parameter to be measured.

A_{is} = Response for the internal standard.

C_{is} = Concentration of the internal standard ($\mu\text{g/L}$).

C_s = Concentration of the parameter to be measured ($\mu\text{g/L}$).

If the RF value over the working range is a constant (<10% RSD), the RF can be assumed to be invariant and the average RF can be used for calculations. Alternatively, the results can be used to plot a calibration curve of response ratios, A_s/A_{is} , vs. RF.

7.4 The working calibration curve, calibration factor, or RF must be verified on each working day by the measurement of one or more calibration standards. If the response for any parameter varies from the predicted response by more than $\pm 15\%$, a new calibration curve must be prepared for that compound.

7.5 Before using any cleanup procedure, the analyst must process a series of calibration standards through the procedure to validate elution patterns and the absence of interferences from the reagents.

8. Quality Control

8.1 Each laboratory that uses this method is required to operate a formal quality control program. The minimum requirements of this program consist of an initial demonstration of laboratory capability and an ongoing analysis of spiked samples to evaluate and document data quality. The laboratory must maintain records to document the quality of data that is generated. Ongoing data quality checks are compared with established performance criteria to determine if the results of analyses meet the performance characteristics of the method. When results of sample spikes indicate atypical method performance, a quality control check standard must be analyzed to confirm that the measurements were performed in an in-control mode of operation.

8.1.1 The analyst must make an initial, one-time, demonstration of the ability to generate acceptable accuracy and precision with this method. This ability is established as described in Section 8.2.

8.1.2 In recognition of advances that are occurring in chromatography, the analyst is permitted certain options (detailed in Sections 10.4, 11.1, and 12.1) to improve the separations or lower the cost of measurements.

Each time such a modification is made to the method, the analyst is required to repeat the procedure in Section 8.2.

8.1.3 Before processing any samples, the analyst must analyze a reagent water blank to demonstrate that interferences from the analytical system and glassware are under control. Each time a set of samples is extracted or reagents are changed, a reagent water blank must be processed as a safeguard against laboratory contamination.

8.1.4 The laboratory must, on an ongoing basis, spike and analyze a minimum of 10% of all samples to monitor and evaluate laboratory data quality. This procedure is described in Section 8.3.

8.1.5 The laboratory must, on an ongoing basis, demonstrate through the analyses of quality control check standards that the operation of the measurement system is in control. This procedure is described in Section 8.4. The frequency of the check standard analyses is equivalent to 10% of all samples analyzed but may be reduced if spike recoveries from samples (Section 8.3) meet all specified quality control criteria.

8.1.6 The laboratory must maintain performance records to document the quality of data that is generated. This procedure is described in Section 8.5.

8.2 To establish the ability to generate acceptable accuracy and precision, the analyst must perform the following operations.

8.2.1 A quality control (QC) check sample concentrate is required containing each parameter of interest at the following concentrations in acetone: butyl benzyl phthalate, 10 $\mu\text{g/mL}$; bis(2-ethylhexyl) phthalate, 50 $\mu\text{g/mL}$; di-n-octyl phthalate, 50 $\mu\text{g/mL}$; any other phthalate, 25 $\mu\text{g/mL}$. The QC check sample concentrate must be obtained from the U.S. Environmental Protection Agency, Environmental Monitoring and Support Laboratory in Cincinnati, Ohio, if available. If not available from that source, the QC check sample concentrate must be obtained from another external source. If not available from either source above, the QC check sample concentrate must be prepared by the laboratory using stock standards prepared independently from those used for calibration.

8.2.2 Using a pipet, prepare QC check samples at the test concentrations shown in Table 2 by adding 1.00 mL of QC check sample concentrate to each of four 1-L aliquots of reagent water.

8.2.3 Analyze the well-mixed QC check samples according to the method beginning in Section 10.

8.2.4 Calculate the average recovery (\bar{X}) in $\mu\text{g/L}$, and the standard deviation of the recovery (s) in $\mu\text{g/L}$, for each parameter using the four results.

8.2.5 For each parameter compare s and \bar{X} with the corresponding acceptance criteria for precision and accuracy, respectively,

found in Table 2. If s and \bar{X} for all parameters of interest meet the acceptance criteria, the system performance is acceptable and analysis of actual samples can begin. If any individual s exceeds the precision limit or any individual \bar{X} falls outside the range for accuracy, the system performance is unacceptable for that parameter. Locate and correct the source of the problem and repeat the test for all parameters of interest beginning with Section 8.2.2.

8.3 The laboratory must, on an ongoing basis, spike at least 10% of the samples from each sample site being monitored to assess accuracy. For laboratories analyzing one to ten samples per month, at least one spiked sample per month is required.

8.3.1 The concentration of the spike in the sample should be determined as follows:

8.3.1.1 If, as in compliance monitoring, the concentration of a specific parameter in the sample is being checked against a regulatory concentration limit, the spike should be at that limit or 1 to 5 times higher than the background concentration determined in Section 8.3.2, whichever concentration would be larger.

8.3.1.2 If the concentration of a specific parameter in the sample is not being checked against a limit specific to that parameter, the spike should be at the test concentration in Section 8.2.2 or 1 to 5 times higher than the background concentration determined in Section 8.3.2, whichever concentration would be larger.

8.3.1.3 If it is impractical to determine background levels before spiking (e.g., maximum holding times will be exceeded), the spike concentration should be (1) the regulatory concentration limit, if any; or, if none (2) the larger of either 5 times higher than the expected background concentration or the test concentration in Section 8.2.2.

8.3.2 Analyze one sample aliquot to determine the background concentration (B) of each parameter. If necessary, prepare a new QC check sample concentrate (Section 8.2.1) appropriate for the background concentrations in the sample. Spike a second sample aliquot with 1.0 mL of the QC check sample concentrate and analyze it to determine the concentration after spiking (A) of each parameter. Calculate each percent recovery (P) as $100(A-B)/T$, where T is the known true value of the spike.

8.3.3 Compare the percent recovery (P) for each parameter with the corresponding QC acceptance criteria found in Table 2. These acceptance criteria were calculated to include an allowance for error in measurement of both the background and spike concentrations, assuming a spike to background ratio of 5:1. This error will be accounted for to the extent that the analyst's spike to background ratio approaches 5:1.⁹ If spiking was performed at a concentration lower than the test concentration in Section 8.2.2, the ana-

lyst must use either the QC acceptance criteria in Table 2, or optional QC acceptance criteria calculated for the specific spike concentration. To calculate optional acceptance criteria for the recovery of a parameter: (1) Calculate accuracy (\bar{X}) using the equation in Table 3, substituting the spike concentration (T) for C; (2) calculate overall precision (S') using the equation in Table 3, substituting \bar{X} for \bar{X} ; (3) calculate the range for recovery at the spike concentration as $(100 \bar{X}'/T) \pm 2.44(100 S'/T)\%$.⁹

8.3.4 If any individual P falls outside the designated range for recovery, that parameter has failed the acceptance criteria. A check standard containing each parameter that failed the criteria must be analyzed as described in Section 8.4.

8.4 If any parameter fails the acceptance criteria for recovery in Section 8.3, a QC check standard containing each parameter that failed must be prepared and analyzed.

NOTE: The frequency for the required analysis of a QC check standard will depend upon the number of parameters being simultaneously tested, the complexity of the sample matrix, and the performance of the laboratory.

8.4.1 Prepare the QC check standard by adding 1.0 mL of QC check sample concentrate (Section 8.2.1 or 8.3.2) to 1 L of reagent water. The QC check standard needs only to contain the parameters that failed criteria in the test in Section 8.3.

8.4.2 Analyze the QC check standard to determine the concentration measured (A) of each parameter. Calculate each percent recovery (P_s) as $100(A/T)\%$, where T is the true value of the standard concentration.

8.4.3 Compare the percent recovery (P_s) for each parameter with the corresponding QC acceptance criteria found in Table 2. Only parameters that failed the test in Section 8.3 need to be compared with these criteria. If the recovery of any such parameter falls outside the designated range, the laboratory performance for that parameter is judged to be out of control, and the problem must be immediately identified and corrected. The analytical result for that parameter in the unspiked sample is suspect and may not be reported for regulatory compliance purposes.

8.5 As part of the QC program for the laboratory, method accuracy for wastewater samples must be assessed and records must be maintained. After the analysis of five spiked wastewater samples as in Section 8.3, calculate the average percent recovery (\bar{P}) and the standard deviation of the percent recovery (s_p). Express the accuracy assessment as a percent recovery interval from $\bar{P} - 2s_p$ to $\bar{P} + 2s_p$. If $\bar{P} = 90\%$ and $s_p = 10\%$, for example, the accuracy interval is expressed as 70-110%. Update the accuracy assessment for each parameter on a regular basis (e.g. after each five to ten new accuracy measurements).

8.6 It is recommended that the laboratory adopt additional quality assurance practices for use with this method. The specific practices that are most productive depend upon the needs of the laboratory and the nature of the samples. Field duplicates may be analyzed to assess the precision of the environmental measurements. When doubt exists over the identification of a peak on the chromatogram, confirmatory techniques such as gas chromatography with a dissimilar column, specific element detector, or mass spectrometer must be used. Whenever possible, the laboratory should analyze standard reference materials and participate in relevant performance evaluation studies.

9. Sample Collection, Preservation, and Handling

9.1 Grab samples must be collected in glass containers. Conventional sampling practices¹⁰ should be followed, except that the bottle must not be prerinsed with sample before collection. Composite samples should be collected in refrigerated glass containers in accordance with the requirements of the program. Automatic sampling equipment must be as free as possible of Tygon tubing and other potential sources of contamination.

9.2 All samples must be iced or refrigerated at 4 °C from the time of collection until extraction.

9.3 All samples must be extracted within 7 days of collection and completely analyzed within 40 days of extraction.²

10. Sample Extraction

10.1 Mark the water meniscus on the side of the sample bottle for later determination of sample volume. Pour the entire sample into a 2-L separatory funnel.

10.2 Add 60 mL of methylene chloride to the sample bottle, seal, and shake 30 s to rinse the inner surface. Transfer the solvent to the separatory funnel and extract the sample by shaking the funnel for 2 min. with periodic venting to release excess pressure. Allow the organic layer to separate from the water phase for a minimum of 10 min. If the emulsion interface between layers is more than one-third the volume of the solvent layer, the analyst must employ mechanical techniques to complete the phase separation. The optimum technique depends upon the sample, but may include stirring, filtration of the emulsion through glass wool, centrifugation, or other physical methods. Collect the methylene chloride extract in a 250-mL Erlenmeyer flask.

10.3 Add a second 60-mL volume of methylene chloride to the sample bottle and repeat the extraction procedure a second time, combining the extracts in the Erlenmeyer flask. Perform a third extraction in the same manner.

10.4 Assemble a Kuderna-Danish (K-D) concentrator by attaching a 10-mL concentrator tube to a 500-mL evaporative flask. Other concentrator devices or techniques may be used in place of the K-D concentrator if the requirements of Section 8.2 are met.

10.5 Pour the combined extract through a solvent-rinsed drying column containing about 10 cm of anhydrous sodium sulfate, and collect the extract in the K-D concentrator. Rinse the Erlenmeyer flask and column with 20 to 30 mL of methylene chloride to complete the quantitative transfer.

10.6 Add one or two clean boiling chips to the evaporative flask and attach a three-ball Snyder column. Prewet the Snyder column by adding about 1 mL of methylene chloride to the top. Place the K-D apparatus on a hot water bath (60 to 65 °C) so that the concentrator tube is partially immersed in the hot water, and the entire lower rounded surface of the flask is bathed with hot vapor. Adjust the vertical position of the apparatus and the water temperature as required to complete the concentration in 15 to 20 min. At the proper rate of distillation the balls of the column will actively chatter but the chambers will not flood with condensed solvent. When the apparent volume of liquid reaches 1 mL, remove the K-D apparatus and allow it to drain and cool for at least 10 min.

10.7 Increase the temperature of the hot water bath to about 80 °C. Momentarily remove the Snyder column, add 50 mL of hexane and a new boiling chip, and reattach the Snyder column. Concentrate the extract as in Section 10.6, except use hexane to prewet the column. The elapsed time of concentration should be 5 to 10 min.

10.8 Remove the Snyder column and rinse the flask and its lower joint into the concentrator tube with 1 to 2 mL of hexane. A 5-mL syringe is recommended for this operation. Adjust the extract volume to 10 mL. Stopper the concentrator tube and store refrigerated if further processing will not be performed immediately. If the extract will be stored longer than two days, it should be transferred to a Teflon-sealed screw-cap vial. If the sample extract requires no further cleanup, proceed with gas chromatographic analysis (Section 12). If the sample requires further cleanup, proceed to Section 11.

10.9 Determine the original sample volume by refilling the sample bottle to the mark and transferring the liquid to a 1000-mL graduated cylinder. Record the sample volume to the nearest 5 mL.

11. Cleanup and Separation

11. Cleanup procedures may not be necessary for a relatively clean sample matrix. If particular circumstances demand the use of a cleanup procedure, the analyst may use either procedure below or any other appropriate procedure. However, the analyst first must demonstrate that the requirements of

Section 8.2 can be met using the method as revised to incorporate the cleanup procedure.

11.2 If the entire extract is to be cleaned up by one of the following procedures, it must be concentrated to 2.0 mL. To the concentrator tube in Section 10.8, add a clean boiling chip and attach a two-ball micro-Snyder column. Prewet the column by adding about 0.5 mL of hexane to the top. Place the micro-K-D apparatus on a hot water bath (80 °C) so that the concentrator tube is partially immersed in the hot water. Adjust the vertical position of the apparatus and the water temperature as required to complete the concentration in 5 to 10 min. At the proper rate of distillation the balls of the column will actively chatter but the chambers will not flood. When the apparent volume of liquid reaches about 0.5 mL, remove the K-D apparatus and allow it to drain and cool for at least 10 min. Remove the micro-Snyder column and rinse its lower joint into the concentrator tube with 0.2 mL of hexane. Adjust the final volume to 2.0 mL and proceed with one of the following cleanup procedures.

11.3 Florisil column cleanup for phthalate esters:

11.3.1 Place 10 g of Florisil into a chromatographic column. Tap the column to settle the Florisil and add 1 cm of anhydrous sodium sulfate to the top.

11.3.2 Preluete the column with 40 mL of hexane. The rate for all elutions should be about 2 mL/min. Discard the eluate and just prior to exposure of the sodium sulfate layer to the air, quantitatively transfer the 2-mL sample extract onto the column using an additional 2 mL of hexane to complete the transfer. Just prior to exposure of the sodium sulfate layer to the air, add 40 mL of hexane and continue the elution of the column. Discard this hexane eluate.

11.3.3 Next, elute the column with 100 mL of 20% ethyl ether in hexane (V/V) into a 500-mL K-D flask equipped with a 10-mL concentrator tube. Concentrate the collected fraction as in Section 10.6. No solvent exchange is necessary. Adjust the volume of the cleaned up extract to 10 mL in the concentrator tube and analyze by gas chromatography (Section 12).

11.4 Alumina column cleanup for phthalate esters:

11.4.1 Place 10 g of alumina into a chromatographic column. Tap the column to settle the alumina and add 1 cm of anhydrous sodium sulfate to the top.

11.4.2 Preluete the column with 40 mL of hexane. The rate for all elutions should be about 2 mL/min. Discard the eluate and just prior to exposure of the sodium sulfate layer to the air, quantitatively transfer the 2-mL sample extract onto the column using an additional 2 mL of hexane to complete the transfer. Just prior to exposure of the sodium sulfate layer to the air, add 35 mL of

hexane and continue the elution of the column. Discard this hexane eluate.

11.4.3 Next, elute the column with 140 mL of 20% ethyl ether in hexane (V/V) into a 500-mL K-D flask equipped with a 10-mL concentrator tube. Concentrate the collected fraction as in Section 10.6. No solvent exchange is necessary. Adjust the volume of the cleaned up extract to 10 mL in the concentrator tube and analyze by gas chromatography (Section 12).

12. Gas Chromatography

12.1 Table 1 summarizes the recommended operating conditions for the gas chromatograph. Included in this table are retention times and MDL that can be achieved under these conditions. Examples of the separations achieved by Column 1 are shown in Figures 1 and 2. Other packed or capillary (open-tubular) columns, chromatographic conditions, or detectors may be used if the requirements of Section 8.2 are met.

12.2 Calibrate the system daily as described in Section 7.

12.3 If the internal standard calibration procedure is being used, the internal standard must be added to the sample extract and mixed thoroughly immediately before injection into the gas chromatograph.

12.4 Inject 2 to 5 μ L of the sample extract or standard into the gas-chromatograph using the solvent-flush technique.¹¹ Smaller (1.0 μ L) volumes may be injected if automatic devices are employed. Record the volume injected to the nearest 0.05 μ L, and the resulting peak size in area or peak height units.

12.5 Identify the parameters in the sample by comparing the retention times of the peaks in the sample chromatogram with those of the peaks in standard chromatograms. The width of the retention time window used to make identifications should be based upon measurements of actual retention time variations of standards over the course of a day. Three times the standard deviation of a retention time for a compound can be used to calculate a suggested window size; however, the experience of the analyst should weigh heavily in the interpretation of chromatograms.

12.6 If the response for a peak exceeds the working range of the system, dilute the extract and reanalyze.

12.7 If the measurement of the peak response is prevented by the presence of interferences, further cleanup is required.

13. Calculations

13.1 Determine the concentration of individual compounds in the sample.

13.1.1 If the external standard calibration procedure is used, calculate the amount of material injected from the peak response using the calibration curve or calibration

factor determined in Section 7.2.2. The concentration in the sample can be calculated from Equation 2.

$$\text{Concentration } (\mu\text{g/L}) = \frac{(A)(V_t)}{(V_i)(V_s)}$$

Equation 2

where:

A=Amount of material injected (ng).

V_i=Volume of extract injected (μL).

V_t=Volume of total extract (μL).

V_s=Volume of water extracted (mL).

13.1.2 If the internal standard calibration procedure is used, calculate the concentration in the sample using the response factor (RF) determined in Section 7.3.2 and Equation 3.

$$\text{Concentration } (\mu\text{g/L}) = \frac{(A_s)(I_s)}{(A_{is})(RF)(V_o)}$$

Equation 3

where:

A_s=Response for the parameter to be measured.

A_{is}=Response for the internal standard.

I_s=Amount of internal standard added to each extract (μg).

V_o=Volume of water extracted (L).

13.2 Report results in μg/L without correction for recovery data. All QC data obtained should be reported with the sample results.

14. Method Performance

14.1 The method detection limit (MDL) is defined as the minimum concentration of a substance that can be measured and reported with 99% confidence that the value is above zero.¹ The MDL concentrations listed in Table 1 were obtained using reagent water.¹² Similar results were achieved using representative wastewaters. The MDL actually achieved in a given analysis will vary depending on instrument sensitivity and matrix effects.

14.2 This method has been tested for linearity of spike recovery from reagent water and has been demonstrated to be applicable over the concentration range from 5 × MDL to 1000 × MDL with the following exceptions: dimethyl and diethyl phthalate recoveries at 1000 × MDL were low (70%); bis-2-ethylhexyl and di-n-octyl phthalate recoveries at 5 × MDL were low (60%).¹²

14.3 This method was tested by 16 laboratories using reagent water, drinking water, surface water, and three industrial wastewaters spiked at six concentrations over the range 0.7 to 106 μg/L.¹³ Single operator precision, overall precision, and method accuracy were found to be directly related to the concentration of the parameter and es-

entially independent of the sample matrix. Linear equations to describe these relationships are presented in Table 3.

References

- 40 CFR part 136, appendix B.
- "Determination of Phthalates in Industrial and Municipal Wastewaters," EPA 600/4-81-063, National Technical Information Service, PB81-232167, Springfield, Virginia 22161, July 1981.
- ASTM Annual Book of Standards, Part 31, D3694-78. "Standard Practices for Preparation of Sample Containers and for Preservation of Organic Constituents," American Society for Testing and Materials, Philadelphia.
- Giam, C.S., Chan, H.S., and Nef, G.S. "Sensitive Method for Determination of Phthalate Ester Plasticizers in Open-Ocean Biota Samples," *Analytical Chemistry*, 47, 2225 (1975).
- Giam, C.S., and Chan, H.S. "Control of Blanks in the Analysis of Phthalates in Air and Ocean Biota Samples," U.S. National Bureau of Standards, Special Publication 442, pp. 701-708, 1976.
- "Carcinogens—Working with Carcinogens," Department of Health, Education, and Welfare, Public Health Service, Center for Disease Control, National Institute for Occupational Safety and Health, Publication No. 77-206, August 1977.
- "OSHA Safety and Health Standards, General Industry," (29 CFR part 1910), Occupational Safety and Health Administration, OSHA 2206 (Revised, January 1976).
- "Safety in Academic Chemistry Laboratories," American Chemical Society Publication, Committee on Chemical Safety, 3rd Edition, 1979.
- Provost L.P., and Elder, R.S. "Interpretation of Percent Recovery Data," *American Laboratory*, 15, 58-63 (1983). (The value 2.44 used in the equation in Section 8.3.3 is two times the value 1.22 derived in this report.)
- ASTM Annual Book of Standards, Part 31, D3370-76. "Standard Practices for Sampling Water," American Society for Testing and Materials, Philadelphia.
- Burke, J.A. "Gas Chromatography for Pesticide Residue Analysis; Some Practical Aspects," *Journal of the Association of Official Analytical Chemists*, 48, 1037 (1965).
- "Method Detection Limit and Analytical Curve Studies, EPA Methods 606, 607, and 608," Special letter report for EPA Contract 68-03-2606, U.S. Environmental Protection Agency, Environmental Monitoring and Support Laboratory, Cincinnati, Ohio 45268, June 1980.
- "EPA Method Study 16 Method 606 (Phthalate Esters)," EPA 600/4-84-056, National Technical Information Service, PB84-211275, Springfield, Virginia 22161, June 1984.

TABLE 1—CHROMATOGRAPHIC CONDITIONS AND METHOD DETECTION LIMITS

| Parameter | Retention time (min) | | Method detection limit (µg/L) |
|-----------------------------------|----------------------|-------------------|-------------------------------|
| | Column 1 | Column 2 | |
| Dimethyl phthalate | 2.03 | 0.95 | 0.29 |
| Diethyl phthalate | 2.82 | 1.27 | 0.49 |
| Di-n-butyl phthalate | 8.65 | 3.50 | 0.36 |
| Butyl benzyl phthalate | ^a 6.94 | ^a 5.11 | 0.34 |
| Bis(2-ethylhexyl) phthalate | ^a 8.92 | ^a 10.5 | 2.0 |
| Di-n-octyl phthalate | ^a 16.2 | ^a 18.0 | 3.0 |

Column 1 conditions: Supelcoport (100/120 mesh) coated with 1.5% SP-2250/1.95% SP-2401 packed in a 1.8 m long × 4 mm ID glass column with 5% methane/95% argon carrier gas at 60 mL/min flow rate. Column temperature held isothermal at 180°C, except where otherwise indicated.

Column 2 conditions: Supelcoport (100/120 mesh) coated with 3% OV-1 packed in a 1.8 m long × 4 mm ID glass column with 5% methane/95% argon carrier gas at 60 mL/min flow rate. Column temperature held isothermal at 200 °C, except where otherwise indicated.

^a220 °C column temperature.

TABLE 2—QC ACCEPTANCE CRITERIA—METHOD 606

| Parameter | Test conc. (µg/L) | Limit for s (µg/L) | Range for X (µg/L) | Range for P, P _s (percent) |
|-----------------------------------|-------------------|--------------------|--------------------|---------------------------------------|
| Bis(2-ethylhexyl) phthalate | 50 | 38.4 | 1.2–55.9 | D–158 |
| Butyl benzyl phthalate | 10 | 4.2 | 5.7–11.0 | 30–136 |
| Di-n-butyl phthalate | 25 | 8.9 | 10.3–29.6 | 23–136 |
| Diethyl phthalate | 25 | 9.0 | 1.9–33.4 | D–149 |
| Dimethyl phthalate | 25 | 9.5 | 1.3–35.5 | D–156 |
| Di-n-octyl phthalate | 50 | 13.4 | D–50.0 | D–114 |

s=Standard deviation of four recovery measurements, in µg/L (Section 8.2.4).

X=Average recovery for four recovery measurements, in µg/L (Section 8.2.4).

P, P_s=Percent recovery measured (Section 8.3.2, Section 8.4.2).

D=Detected; result must be greater than zero.

Note: These criteria are based directly upon the method performance data in Table 3. Where necessary, the limits for recovery have been broadened to assure applicability of the limits to concentrations below those used to develop Table 3.

TABLE 3—METHOD ACCURACY AND PRECISION AS FUNCTIONS OF CONCENTRATION—METHOD 606

| Parameter | Accuracy, as recovery, X' (µg/L) | Single analyst precision, s _r ' (µg/L) | Overall precision, S' (µg/L) |
|-----------------------------------|----------------------------------|---|------------------------------|
| Bis(2-ethylhexyl) phthalate | 0.53C+2.02 | 0.80X̄ – 2.54 | 0.73X̄ – 0.17 |
| Butyl benzyl phthalate | 0.82C+0.13 | 0.26X̄+0.04 | 0.25X̄+0.07 |
| Di-n-butyl phthalate | 0.79C+0.17 | 0.23X̄+0.20 | 0.29X̄+0.06 |
| Diethyl phthalate | 0.70C+0.13 | 0.27X̄+0.05 | 0.45X̄+0.11 |
| Dimethyl phthalate | 0.73C+0.17 | 0.26X̄+0.14 | 0.44X̄+0.31 |
| Di-n-octyl phthalate | 0.35C – 0.71 | 0.38X̄+0.71 | 0.62X̄+0.34 |

X̄=Expected recovery for one or more measurements of a sample containing a concentration of C, in µg/L.

s_r'=Expected single analyst standard deviation of measurements at an average concentration found of X̄, in µg/L.

S'=Expected interlaboratory standard deviation of measurements at an average concentration found of X̄, in µg/L.

C=True value for the concentration, in µg/L.

X=Average recovery found for measurements of samples containing a concentration of C, in µg/L.

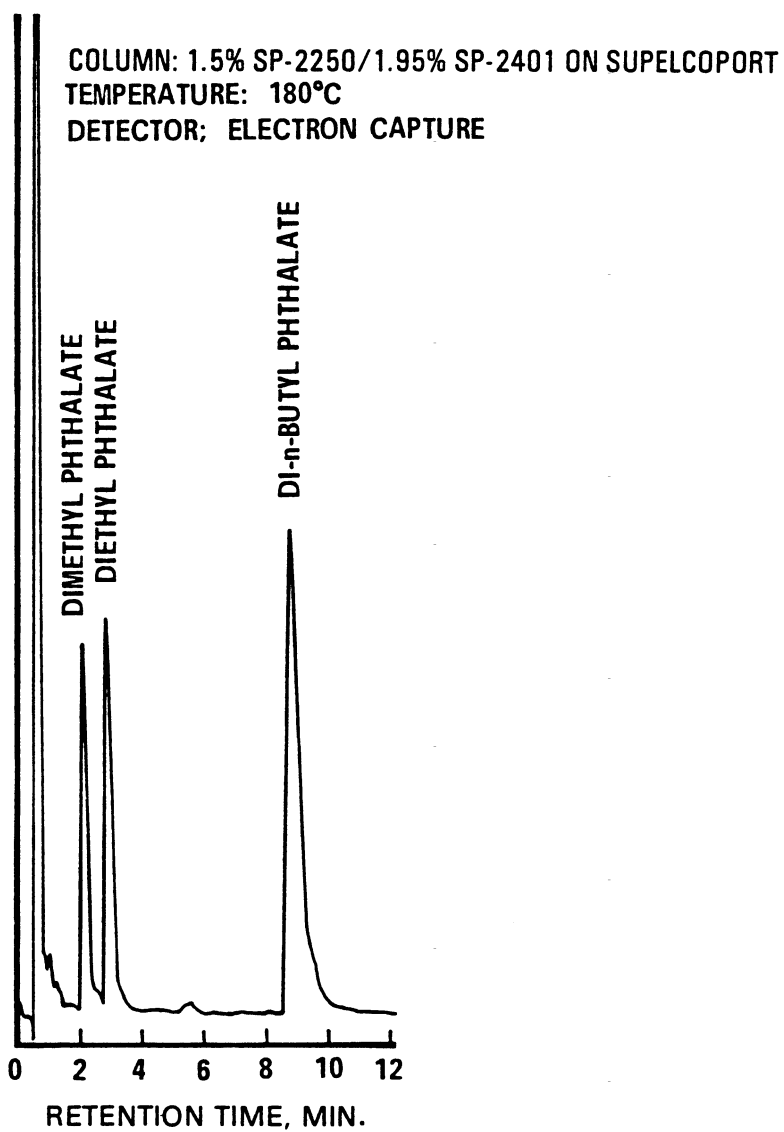

Figure 1. Gas chromatogram of phthalates.

COLUMN: 1.5% SP-2250/1.95% SP-2401 ON SUPELCOPORT
TEMPERATURE: 220°C
DETECTOR: ELECTRON CAPTURE

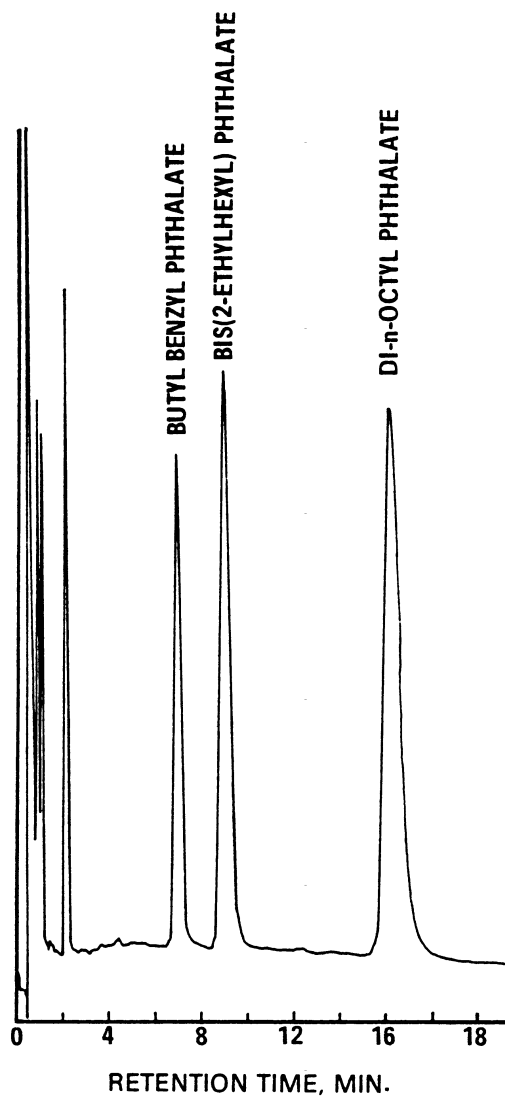

Figure 2. Gas chromatogram of phthalates.

Environmental Protection Agency

Pt. 136, App. A, Meth. 607

METHOD 607—NITROSAMINES

1. Scope and Application

1.1 This method covers the determination of certain nitrosamines. The following parameters can be determined by this method:

| Parameter | Storet No. | CAS No. |
|---------------------------------|------------|----------|
| N-Nitrosodimethylamine | 34438 | 62-75-9 |
| N-Nitrosodiphenylamine | 34433 | 86-30-6 |
| N-Nitrosodi-n-propylamine | 34428 | 621-64-7 |

1.2 This is a gas chromatographic (GC) method applicable to the determination of the parameters listed above in municipal and industrial discharges as provided under 40 CFR 136.1. When this method is used to analyze unfamiliar samples for any or all of the compounds above, compound identifications should be supported by at least one additional qualitative technique. This method describes analytical conditions for a second gas chromatographic column that can be used to confirm measurements made with the primary column. Method 625 provides gas chromatograph/mass spectrometer (GC/MS) conditions appropriate for the qualitative and quantitative confirmation of results for N-nitrosodi-n-propylamine. In order to confirm the presence of N-nitrosodiphenylamine, the cleanup procedure specified in Section 11.3 or 11.4 must be used. In order to confirm the presence of N-nitrosodimethylamine by GC/MS, Column 1 of this method must be substituted for the column recommended in Method 625. Confirmation of these parameters using GC-high resolution mass spectrometry or a Thermal Energy Analyzer is also recommended.^{1,2}

1.3 The method detection limit (MDL, defined in Section 14.1)³ for each parameter is listed in Table 1. The MDL for a specific wastewater may differ from those listed, depending upon the nature of interferences in the sample matrix.

1.4 Any modification of this method, beyond those expressly permitted, shall be considered as a major modification subject to application and approval of alternate test procedures under 40 CFR 136.4 and 136.5.

1.5 This method is restricted to use by or under the supervision of analysts experienced in the use of a gas chromatograph and in the interpretation of gas chromatograms. Each analyst must demonstrate the ability to generate acceptable results with this method using the procedure described in Section 8.2.

2. Summary of Method

2.1 A measured volume of sample, approximately 1-L, is extracted with methylene chloride using a separatory funnel. The methylene chloride extract is washed with dilute hydrochloric acid to remove free amines, dried, and concentrated to a volume

of 10 mL or less. After the extract has been exchanged to methanol, it is separated by gas chromatography and the parameters are then measured with a nitrogen-phosphorus detector.⁴

2.2 The method provides Florisil and alumina column cleanup procedures to separate diphenylamine from the nitrosamines and to aid in the elimination of interferences that may be encountered.

3. Interferences

3.1 Method interferences may be caused by contaminants in solvents, reagents, glassware, and other sample processing hardware that lead to discrete artifacts and/or elevated baselines in gas chromatograms. All of these materials must be routinely demonstrated to be free from interferences under the conditions of the analysis by running laboratory reagent blanks as described in Section 8.1.3.

3.1.1 Glassware must be scrupulously cleaned.⁵ Clean all glassware as soon as possible after use by rinsing with the last solvent used in it. Solvent rinsing should be followed by detergent washing with hot water, and rinses with tap water and distilled water. The glassware should then be drained dry, and heated in a muffle furnace at 400 °C for 15 to 30 min. Solvent rinses with acetone and pesticide quality hexane may be substituted for the muffle furnace heating. Volumetric ware should not be heated in a muffle furnace. After drying and cooling, glassware should be sealed and stored in a clean environment to prevent any accumulation of dust or other contaminants. Store inverted or capped with aluminum foil.

3.1.2 The use of high purity reagents and solvents helps to minimize interference problems. Purification of solvents by distillation in all-glass systems may be required.

3.2 Matrix interferences may be caused by contaminants that are co-extracted from the sample. The extent of matrix interferences will vary considerably from source to source, depending upon the nature and diversity of the industrial complex or municipality being sampled. The cleanup procedures in Section 11 can be used to overcome many of these interferences, but unique samples may require additional cleanup approaches to achieve the MDL listed in Table 1.

3.3 N-Nitrosodiphenylamine is reported⁶⁻⁹ to undergo transnitrosation reactions. Care must be exercised in the heating or concentrating of solutions containing this compound in the presence of reactive amines.

3.4 The sensitive and selective Thermal Energy Analyzer and the reductive Hall detector may be used in place of the nitrogen-phosphorus detector when interferences are encountered. The Thermal Energy Analyzer offers the highest selectivity of the non-MS detectors.

4. Safety

4.1 The toxicity or carcinogenicity of each reagent used in this method has not been precisely defined; however, each chemical compound should be treated as a potential health hazard. From this viewpoint, exposure to these chemicals must be reduced to the lowest possible level by whatever means available. The laboratory is responsible for maintaining a current awareness file of OSHA regulations regarding the safe handling of the chemicals specified in this method. A reference file of material data handling sheets should also be made available to all personnel involved in the chemical analysis. Additional references to laboratory safety are available and have been identified¹⁰⁻¹² for the information of the analyst.

4.2 These nitrosamines are known carcinogens,¹³⁻¹⁷ therefore, utmost care must be exercised in the handling of these materials. Nitrosamine reference standards and standard solutions should be handled and prepared in a ventilated glove box within a properly ventilated room.

5. Apparatus and Materials

5.1 Sampling equipment, for discrete or composite sampling.

5.1.1 Grab sample bottle—1-L or 1-qt, amber glass, fitted with a screw cap lined with Teflon. Foil may be substituted for Teflon if the sample is not corrosive. If amber bottles are not available, protect samples from light. The bottle and cap liner must be washed, rinsed with acetone or methylene chloride, and dried before use to minimize contamination.

5.1.2 Automatic sampler (optional)—The sampler must incorporate glass sample containers for the collection of a minimum of 250 mL of sample. Sample containers must be kept refrigerated at 4 °C and protected from light during compositing. If the sampler uses a peristaltic pump, a minimum length of compressible silicone rubber tubing may be used. Before use, however, the compressible tubing should be thoroughly rinsed with methanol, followed by repeated rinsings with distilled water to minimize the potential for contamination of the sample. An integrating flowmeter is required to collect flow proportional composites.

5.2 Glassware (All specifications are suggested. Catalog numbers are included for illustration only.):

5.2.1 Separator funnels—2-L and 250-mL, with Teflon stopcock.

5.2.2 Drying column—Chromatographic column, approximately 400 mm long × 19 mm ID, with coarse frit filter disc.

5.2.3 Concentrator tube, Kuderna-Danish—10-mL, graduated (Kontes K-570050-1025 or equivalent). Calibration must be checked at the volumes employed in the test. Ground

glass stopper is used to prevent evaporation of extracts.

5.2.4 Evaporative flask, Kuderna-Danish—500-mL (Kontes K-570001-0500 or equivalent). Attach to concentrator tube with springs.

5.2.5 Snyder column, Kuderna-Danish—Three-ball macro (Kontes K-503000-0121 or equivalent).

5.2.6 Snyder column, Kuderna-Danish—Two-ball micro (Kontes K-569001-0219 or equivalent).

5.2.7 Vials—10 to 15-mL, amber glass, with Teflon-lined screw cap.

5.2.8 Chromatographic column—Approximately 400 mm long × 22 mm ID, with Teflon stopcock and coarse frit filter disc at bottom (Kontes K-420540-0234 or equivalent), for use in Florisil column cleanup procedure.

5.2.9 Chromatographic column—Approximately 300 mm long × 10 mm ID, with Teflon stopcock and coarse frit filter disc at bottom (Kontes K-420540-0213 or equivalent), for use in alumina column cleanup procedure.

5.3 Boiling chips—Approximately 10/40 mesh. Heat to 400 °C for 30 min or Soxhlet extract with methylene chloride.

5.4 Water bath—Heated, with concentric ring cover, capable of temperature control (± 2 °C). The bath should be used in a hood.

5.5 Balance—Analytical, capable of accurately weighing 0.0001 g.

5.6 Gas chromatograph—An analytical system complete with gas chromatograph suitable for on-column injection and all required accessories including syringes, analytical columns, gases, detector, and strip-chart recorder. A data system is recommended for measuring peak areas.

5.6.1 Column 1—1.8 m long × 4 mm ID glass, packed with 10% Carbowax 20 M/2% KOH on Chromosorb W-AW (80/100 mesh) or equivalent. This column was used to develop the method performance statements in Section 14. Guidelines for the use of alternate column packings are provided in Section 12.2.

5.6.2 Column 2—1.8 m long × 4 mm ID glass, packed with 10% SP-2250 on Supelcoport (100/120 mesh) or equivalent.

5.6.3 Detector—Nitrogen-phosphorus, reductive Hall, or Thermal Energy Analyzer detector.^{1,2} These detectors have proven effective in the analysis of wastewaters for the parameters listed in the scope (Section 1.1). A nitrogen-phosphorus detector was used to develop the method performance statements in Section 14. Guidelines for the use of alternate detectors are provided in Section 12.2.

6. Reagents

6.1 Reagent water—Reagent water is defined as a water in which an interferent is not observed at the MDL of the parameters of interest.

6.2 Sodium hydroxide solution (10 N)—Dissolve 40 g of NaOH (ACS) in reagent water and dilute to 100 mL.

6.3 Sodium thiosulfate—(ACS) Granular.

6.4 Sulfuric acid (1+1)—Slowly, add 50 mL of H₂SO₄ (ACS, sp. gr. 1.84) to 50 mL of reagent water.

6.5 Sodium sulfate—(ACS) Granular, anhydrous. Purify by heating at 400 °C for 4 h in a shallow tray.

6.6 Hydrochloric acid (1+9)—Add one volume of concentrated HCl (ACS) to nine volumes of reagent water.

6.7 Acetone, methanol, methylene chloride, pentane—Pesticide quality or equivalent.

6.8 Ethyl ether—Nanograde, redistilled in glass if necessary.

6.8.1 Ethyl ether must be shown to be free of peroxides before it is used as indicated by EM Laboratories Quant test strips. (Available from Scientific Products Co., Cat No. P1126-8, and other suppliers.)

6.8.2 Procedures recommended for removal of peroxides are provided with the test strips. After cleanup, 20 mL of ethyl alcohol preservative must be added to each liter of ether.

6.9 Florisil—PR grade (60/100 mesh). Purchase activated at 1250 °F and store in the dark in glass containers with ground glass stoppers or foil-lined screw caps. Before use, activate each batch at least 16 h at 130 °C in a foil-covered glass container and allow to cool.

6.10 Alumina—Basic activity Super I, W200 series (ICN Life Sciences Group, No. 404571, or equivalent). To prepare for use, place 100 g of alumina into a 500-mL reagent bottle and add 2 mL of reagent water. Mix the alumina preparation thoroughly by shaking or rolling for 10 min and let it stand for at least 2 h. The preparation should be homogeneous before use. Keep the bottle sealed tightly to ensure proper activity.

6.11 Stock standard solutions (1.00 µg/µL)—Stock standard solutions can be prepared from pure standard materials or purchased as certified solutions.

6.11.1 Prepare stock standard solutions by accurately weighing about 0.0100 g of pure material. Dissolve the material in methanol and dilute to volume in a 10-mL volumetric flask. Larger volumes can be used at the convenience of the analyst. When compound purity is assayed to be 96% or greater, the weight can be used without correction to calculate the concentration of the stock standard. Commercially prepared stock standards can be used at any concentration if they are certified by the manufacturer or by an independent source.

6.11.2 Transfer the stock standard solutions into Teflon-sealed screw-cap bottles. Store at 4 °C and protect from light. Stock standard solutions should be checked frequently for signs of degradation or evaporation, especially just prior to preparing calibration standards from them.

6.11.3 Stock standard solutions must be replaced after six months, or sooner if comparison with check standards indicates a problem.

6.12 Quality control check sample concentrate—See Section 8.2.1.

7. Calibration

7.1 Establish gas chromatographic operating conditions equivalent to those given in Table 1. The gas chromatographic system can be calibrated using the external standard technique (Section 7.2) or the internal standard technique (Section 7.3).

7.2 External standard calibration procedure:

7.2.1 Prepare calibration standards at a minimum of three concentration levels for each parameter of interest by adding volumes of one or more stock standards to a volumetric flask and diluting to volume with methanol. One of the external standards should be at a concentration near, but above, the MDL (Table 1) and the other concentrations should correspond to the expected range of concentrations found in real samples or should define the working range of the detector.

7.2.2 Using injections of 2 to 5 µL, analyze each calibration standard according to Section 12 and tabulate peak height or area responses against the mass injected. The results can be used to prepare a calibration curve for each compound. Alternatively, if the ratio of response to amount injected (calibration factor) is a constant over the working range (<10% relative standard deviation, RSD), linearity through the origin can be assumed and the average ratio or calibration factor can be used in place of a calibration curve.

7.3 Internal standard calibration procedure—To use this approach, the analyst must select one or more internal standards that are similar in analytical behavior to the compounds of interest. The analyst must further demonstrate that the measurement of the internal standard is not affected by method or matrix interferences. Because of these limitations, no internal standard can be suggested that is applicable to all samples.

7.3.1 Prepare calibration standards at a minimum of three concentration levels for each parameter of interest by adding volumes of one or more stock standards to a volumetric flask. To each calibration standard, add a known constant amount of one or more internal standards, and dilute to volume with methanol. One of the standards should be at a concentration near, but above, the MDL and the other concentrations should correspond to the expected range of concentrations found in real samples or should define the working range of the detector.

7.3.2 Using injections of 2 to 5 μL , analyze each calibration standard according to Section 12 and tabulate peak height or area responses against concentration for each compound and internal standard. Calculate response factors (RF) for each compound using Equation 1.

$$\text{RF} = (A_s)(C_{is}) / (A_{is})(C_s)$$

Equation 1

where:

A_s = Response for the parameter to be measured.

A_{is} = Response for the internal standard.

C_{is} = Concentration of the internal standard ($\mu\text{g/L}$).

C_s = Concentration of the parameter to be measured ($\mu\text{g/L}$).

If the RF value over the working range is a constant (<10% RSD), the RF can be assumed to be invariant and the average RF can be used for calculations. Alternatively, the results can be used to plot a calibration curve of response ratios, A_s/A_{is} , vs. RF.

7.4 The working calibration curve, calibration factor, or RF must be verified on each working day by the measurement of one or more calibration standards. If the response for any parameter varies from the predicted response by more than $\pm 15\%$, a new calibration curve must be prepared for that compound.

7.5 Before using any cleanup procedure, the analyst must process a series of calibration standards through the procedure to validate elution patterns and the absence of interferences from the reagents.

8. Quality Control

8.1 Each laboratory that uses this method is required to operate a formal quality control program. The minimum requirements of this program consist of an initial demonstration of laboratory capability and an ongoing analysis of spiked samples to evaluate and document data quality. The laboratory must maintain records to document the quality of data that is generated. Ongoing data quality checks are compared with established performance criteria to determine if the results of analyses meet the performance characteristics of the method. When results of sample spikes indicate atypical method performance, a quality control check standard must be analyzed to confirm that the measurements were performed in an in-control mode of operation.

8.1.1 The analyst must make an initial, one-time, demonstration of the ability to generate acceptable accuracy and precision with this method. This ability is established as described in Section 8.2.

8.1.2 In recognition of advances that are occurring in chromatography, the analyst is permitted certain options (detailed in Sections 10.4, 11.1, and 12.2) to improve the separations or lower the cost of measurements.

Each time such a modification is made to the method, the analyst is required to repeat the procedure in Section 8.2.

8.1.3 Before processing any samples, the analyst must analyze a reagent water blank to demonstrate that interferences from the analytical system and glassware are under control. Each time a set of samples is extracted or reagents are changed, a reagent water blank must be processed as a safeguard against laboratory contamination.

8.1.4 The laboratory must, on an ongoing basis, spike and analyze a minimum of 10% of all samples to monitor and evaluate laboratory data quality. This procedure is described in Section 8.3.

8.1.5 The laboratory must, on an ongoing basis, demonstrate through the analyses of quality control check standards that the operation of the measurement system is in control. This procedure is described in Section 8.4. The frequency of the check standard analyses is equivalent to 10% of all samples analyzed but may be reduced if spike recoveries from samples (Section 8.3) meet all specified quality control criteria.

8.1.6 The laboratory must maintain performance records to document the quality of data that is generated. This procedure is described in Section 8.5.

8.2 To establish the ability to generate acceptable accuracy and precision, the analyst must perform the following operations.

8.2.1 A quality control (QC) check sample concentrate is required containing each parameter of interest at a concentration of 20 $\mu\text{g/mL}$ in methanol. The QC check sample concentrate must be obtained from the U.S. Environmental Protection Agency, Environmental Monitoring and Support Laboratory in Cincinnati, Ohio, if available. If not available from that source, the QC check sample concentrate must be obtained from another external source. If not available from either source above, the QC check sample concentrate must be prepared by the laboratory using stock standards prepared independently from those used for calibration.

8.2.2 Using a pipet, prepare QC check samples at a concentration of 20 $\mu\text{g/L}$ by adding 1.00 mL of QC check sample concentrate to each of four 1-L aliquots of reagent water.

8.2.3 Analyze the well-mixed QC check samples according to the method beginning in Section 10.

8.2.4 Calculate the average recovery (\bar{X}) in $\mu\text{g/L}$, and the standard deviation of the recovery (s) in $\mu\text{g/L}$, for each parameter using the four results.

8.2.5 For each parameter compare s and \bar{X} with the corresponding acceptance criteria for precision and accuracy, respectively, found in Table 2. If s and \bar{X} for all parameters of interest meet the acceptance criteria, the system performance is acceptable and analysis of actual samples can begin. If

any individual s exceeds the precision limit or any individual \bar{X} falls outside the range for accuracy, the system performance is unacceptable for that parameter. Locate and correct the source of the problem and repeat the test for all parameters of interest beginning with Section 8.2.2.

8.3 The laboratory must, on an ongoing basis, spike at least 10% of the samples from each sample site being monitored to assess accuracy. For laboratories analyzing one to ten samples per month, at least one spiked sample per month is required.

8.3.1 The concentration of the spike in the sample should be determined as follows:

8.3.1.1 If, as in compliance monitoring, the concentration of a specific parameter in the sample is being checked against a regulatory concentration limit, the spike should be at that limit or 1 to 5 times higher than the background concentration determined in Section 8.3.2, whichever concentration would be larger.

8.3.1.2 If the concentration of a specific parameter in the sample is not being checked against a limit specific to that parameter, the spike should be at 20 $\mu\text{g/L}$ or 1 to 5 times higher than the background concentration determined in Section 8.3.2, whichever concentration would be larger.

8.3.1.3 If it is impractical to determine background levels before spiking (e.g., maximum holding times will be exceeded), the spike concentration should be (1) the regulatory concentration limit, if any; or, if none (2) the larger of either 5 times higher than the expected background concentration or 20 $\mu\text{g/L}$.

8.3.2 Analyze one sample aliquot to determine the background concentration (B) of each parameter. If necessary, prepare a new QC check sample concentrate (Section 8.2.1) appropriate for the background concentrations in the sample. Spike a second sample aliquot with 1.0 mL of the QC check sample concentrate and analyze it to determine the concentration after spiking (A) of each parameter. Calculate each percent recovery (P) as $100(A-B)/T$, where T is the known true value of the spike.

8.3.3 Compare the percent recovery (P) for each parameter with the corresponding QC acceptance criteria found in Table 2. These acceptance criteria were calculated to include an allowance for error in measurement of both the background and spike concentrations, assuming a spike to background ratio of 5:1. This error will be accounted for to the extent that the analyst's spike to background ratio approaches 5:1.¹⁸ If spiking was performed at a concentration lower than 20 $\mu\text{g/L}$, the analyst must use either the QC acceptance criteria in Table 2, or optional QC acceptance criteria calculated for the specific spike concentration. To calculate optional acceptance criteria for the recovery of a parameter: (1) Calculate accuracy (X')

using the equation in Table 3, substituting the spike concentration (T) for C; (2) calculate overall precision (S') using the equation in Table 3, substituting X' for \bar{X} ; (3) calculate the range for recovery at the spike concentration as $(100 X'/T) \pm 2.44(100 S'/T)\%$.¹⁸

8.3.4 If any individual P falls outside the designated range for recovery, that parameter has failed the acceptance criteria. A check standard containing each parameter that failed the criteria must be analyzed as described in Section 8.4.

8.4 If any parameter fails the acceptance criteria for recovery in Section 8.3, a QC check standard containing each parameter that failed must be prepared and analyzed.

NOTE: The frequency for the required analysis of a QC check standard will depend upon the number of parameters being simultaneously tested, the complexity of the sample matrix, and the performance of the laboratory.

8.4.1 Prepare the QC check standard by adding 1.0 mL of QC check sample concentrate (Section 8.2.1 or 8.3.2) to 1 L of reagent water. The QC check standard needs only to contain the parameters that failed criteria in the test in Section 8.3.

8.4.2 Analyze the QC check standard to determine the concentration measured (A) of each parameter. Calculate each percent recovery (P_s) as $100(A/T)\%$, where T is the true value of the standard concentration.

8.4.3 Compare the percent recovery (P_s) for each parameter with the corresponding QC acceptance criteria found in Table 2. Only parameters that failed the test in Section 8.3 need to be compared with these criteria. If the recovery of any such parameter falls outside the designated range, the laboratory performance for that parameter is judged to be out of control, and the problem must be immediately identified and corrected. The analytical result for that parameter in the unspiked sample is suspect and may not be reported for regulatory compliance purposes.

8.5 As part of the QC program for the laboratory, method accuracy for wastewater samples must be assessed and records must be maintained. After the analysis of five spiked wastewater samples as in Section 8.3, calculate the average percent recovery (\bar{P}) and the standard deviation of the percent recovery (s_p). Express the accuracy assessment as a percent recovery interval from $\bar{P} - 2s_p$ to $\bar{P} + 2s_p$. If $\bar{P}=90\%$ and $s_p=10\%$, for example, the accuracy interval is expressed as 70–110%. Update the accuracy assessment for each parameter on a regular basis (e.g. after each five to ten new accuracy measurements).

8.6 It is recommended that the laboratory adopt additional quality assurance practices for use with this method. The specific practices that are most productive depend upon the needs of the laboratory and the nature of

the samples. Field duplicates may be analyzed to assess the precision of the environmental measurements. When doubt exists over the identification of a peak on the chromatogram, confirmatory techniques such as gas chromatography with a dissimilar column, specific element detector, or mass spectrometer must be used. Whenever possible, the laboratory should analyze standard reference materials and participate in relevant performance evaluation studies.

9. Sample Collection, Preservation, and Handling

9.1 Grab samples must be collected in glass containers. Conventional sampling practices¹⁹ should be followed, except that the bottle must not be prerinsed with sample before collection. Composite samples should be collected in refrigerated glass containers in accordance with the requirements of the program. Automatic sampling equipment must be as free as possible of Tygon tubing and other potential sources of contamination.

9.2 All samples must be iced or refrigerated at 4 °C from the time of collection until extraction. Fill the sample bottles and, if residual chlorine is present, add 80 mg of sodium thiosulfate per liter of sample and mix well. EPA Methods 330.4 and 330.5 may be used for measurement of residual chlorine.²⁰ Field test kits are available for this purpose. If N-nitrosodiphenylamine is to be determined, adjust the sample pH to 7 to 10 with sodium hydroxide solution or sulfuric acid.

9.3 All samples must be extracted within 7 days of collection and completely analyzed within 40 days of extraction.⁴

9.4 Nitrosamines are known to be light sensitive.⁷ Samples should be stored in amber or foil-wrapped bottles in order to minimize photolytic decomposition.

10. Sample Extraction

10.1 Mark the water meniscus on the side of the sample bottle for later determination of sample volume. Pour the entire sample into a 2-L separatory funnel. Check the pH of the sample with wide-range pH paper and adjust to within the range of 5 to 9 with sodium hydroxide solution or sulfuric acid.

10.2 Add 60 mL of methylene chloride to the sample bottle, seal, and shake 30 s to rinse the inner surface. Transfer the solvent to the separatory funnel and extract the sample by shaking the funnel for 2 min with periodic venting to release excess pressure. Allow the organic layer to separate from the water phase for a minimum of 10 min. If the emulsion interface between layers is more than one-third the volume of the solvent layer, the analyst must employ mechanical techniques to complete the phase separation. The optimum technique depends upon the

sample, but may include stirring, filtration of the emulsion through glass wool, centrifugation, or other physical methods. Collect the methylene chloride extract in a 250-mL Erlenmeyer flask.

10.3 Add a second 60-mL volume of methylene chloride to the sample bottle and repeat the extraction procedure a second time, combining the extracts in the Erlenmeyer flask. Perform a third extraction in the same manner.

10.4 Assemble a Kuderna-Danish (K-D) concentrator by attaching a 10-mL concentrator tube to a 500-mL evaporative flask. Other concentration devices or techniques may be used in place of the K-D concentrator if the requirements of Section 8.2 are met.

10.5 Add 10 mL of hydrochloric acid to the combined extracts and shake for 2 min. Allow the layers to separate. Pour the combined extract through a solvent-rinsed drying column containing about 10 cm of anhydrous sodium sulfate, and collect the extract in the K-D concentrator. Rinse the Erlenmeyer flask and column with 20 to 30 mL of methylene chloride to complete the quantitative transfer.

10.6 Add one or two clean boiling chips to the evaporative flask and attach a three-ball Snyder column. Prewet the Snyder column by adding about 1 mL of methylene chloride to the top. Place the K-D apparatus on a hot water bath (60 to 65°C) so that the concentrator tube is partially immersed in the hot water, and the entire lower rounded surface of the flask is bathed with hot vapor. Adjust the vertical position of the apparatus and the water temperature as required to complete the concentration in 15 to 20 min. At the proper rate of distillation the balls of the column will actively chatter but the chambers will not flood with condensed solvent. When the apparent volume of liquid reaches 1 mL, remove the K-D apparatus and allow it to drain and cool for at least 10 min.

10.7 Remove the Snyder column and rinse the flask and its lower joint into the concentrator tube with 1 to 2 mL of methylene chloride. A 5-mL syringe is recommended for this operation. Stopper the concentrator tube and store refrigerated if further processing will not be performed immediately. If the extract will be stored longer than two days, it should be transferred to a Teflon-sealed screw-cap vial. If N-nitrosodiphenylamine is to be measured by gas chromatography, the analyst must first use a cleanup column to eliminate diphenylamine interference (Section 11). If N-nitrosodiphenylamine is of no interest, the analyst may proceed directly with gas chromatographic analysis (Section 12).

10.8 Determine the original sample volume by refilling the sample bottle to the mark and transferring the liquid to a 1000-mL graduated cylinder. Record the sample volume to the nearest 5 mL.

11. Cleanup and Separation

11.1 Cleanup procedures may not be necessary for a relatively clean sample matrix. If particular circumstances demand the use of a cleanup procedure, the analyst may use either procedure below or any other appropriate procedure. However, the analyst first must demonstrate that the requirements of Section 8.2 can be met using the method as revised to incorporate the cleanup procedure. Diphenylamine, if present in the original sample extract, must be separated from the nitrosamines if N-nitrosodiphenylamine is to be determined by this method.

11.2 If the entire extract is to be cleaned up by one of the following procedures, it must be concentrated to 2.0 mL. To the concentrator tube in Section 10.7, add a clean boiling chip and attach a two-ball micro-Snyder column. Prewet the column by adding about 0.5 mL of methylene chloride to the top. Place the micr-K-D apparatus on a hot water bath (60 to 65°C) so that the concentrator tube is partially immersed in the hot water. Adjust the vertical position of the apparatus and the water temperature as required to complete the concentration in 5 to 10 min. At the proper rate of distillation the balls of the column will actively chatter but the chambers will not flood. When the apparent volume of liquid reaches about 0.5 mL, remove the K-D apparatus and allow it to drain and cool for at least 10 min. Remove the micro-Snyder column and rinse its lower joint into the concentrator tube with 0.2 mL of methylene chloride. Adjust the final volume to 2.0 mL and proceed with one of the following cleanup procedures.

11.3 Florisil column cleanup for nitrosamines:

11.3.1 Place 22 g of activated Florisil into a 22-mm ID chromatographic column. Tap the column to settle the Florisil and add about 5 mm of anhydrous sodium sulfate to the top.

11.3.2 Preelute the column with 40 mL of ethyl ether/pentane (15+85)(V/V). Discard the eluate and just prior to exposure of the sodium sulfate layer to the air, quantitatively transfer the 2-mL sample extract onto the column using an additional 2 mL of pentane to complete the transfer.

11.3.3 Elute the column with 90 mL of ethyl ether/pentane (15+85)(V/V) and discard the eluate. This fraction will contain the diphenylamine, if it is present in the extract.

11.3.4 Next, elute the column with 100 mL of acetone/ethyl ether (5+95)(V/V) into a 500-mL K-D flask equipped with a 10-mL concentrator tube. This fraction will contain all of the nitrosamines listed in the scope of the method.

11.3.5 Add 15 mL of methanol to the collected fraction and concentrate as in Section 10.6, except use pentane to prewet the column and set the water bath at 70 to 75°C.

When the apparatus is cool, remove the Snyder column and rinse the flask and its lower joint into the concentrator tube with 1 to 2 mL of pentane. Analyze by gas chromatography (Section 12).

11.4 Alumina column cleanup for nitrosamines:

11.4.1 Place 12 g of the alumina preparation (Section 6.10) into a 10-mm ID chromatographic column. Tap the column to settle the alumina and add 1 to 2 cm of anhydrous sodium sulfate to the top.

11.4.2 Preelute the column with 10 mL of ethyl ether/pentane (3+7)(V/V). Discard the eluate (about 2 mL) and just prior to exposure of the sodium sulfate layer to the air, quantitatively transfer the 2 mL sample extract onto the column using an additional 2 mL of pentane to complete the transfer.

11.4.3 Just prior to exposure of the sodium sulfate layer to the air, add 70 mL of ethyl ether/pentane (3+7)(V/V). Discard the first 10 mL of eluate. Collect the remainder of the eluate in a 500-mL K-D flask equipped with a 10 mL concentrator tube. This fraction contains N-nitrosodiphenylamine and probably a small amount of N-nitrosodi-n-propylamine.

11.4.4 Next, elute the column with 60 mL of ethyl ether/pentane (1+1)(V/V), collecting the eluate in a second K-D flask equipped with a 10-mL concentrator tube. Add 15 mL of methanol to the K-D flask. This fraction will contain N-nitrosodimethylamine, most of the N-nitrosodi-n-propylamine and any diphenylamine that is present.

11.4.5 Concentrate both fractions as in Section 10.6, except use pentane to prewet the column. When the apparatus is cool, remove the Snyder column and rinse the flask and its lower joint into the concentrator tube with 1 to 2 mL of pentane. Analyze the fractions by gas chromatography (Section 12).

12. Gas Chromatography

12.1 N-nitrosodiphenylamine completely reacts to form diphenylamine at the normal operating temperatures of a GC injection port (200 to 250°C). Thus, N-nitrosodiphenylamine is chromatographed and detected as diphenylamine. Accurate determination depends on removal of diphenylamine that may be present in the original extract prior to GC analysis (See Section 11).

12.2 Table 1 summarizes the recommended operating conditions for the gas chromatograph. Included in this table are retention times and MDL that can be achieved under these conditions. Examples of the separations achieved by Column 1 are shown in Figures 1 and 2. Other packed or capillary (open-tubular) columns, chromatographic conditions, or detectors may be used if the requirements of Section 8.2 are met.

12.3 Calibrate the system daily as described in Section 7.

12.4 If the extract has not been subjected to one of the cleanup procedures in Section 11, it is necessary to exchange the solvent from methylene chloride to methanol before the thermionic detector can be used. To a 1 to 10-mL volume of methylene chloride extract in a concentrator tube, add 2 mL of methanol and a clean boiling chip. Attach a two-ball micro-Snyder column to the concentrator tube. Prewet the column by adding about 0.5 mL of methylene chloride to the top. Place the micro-K-D apparatus on a boiling (100 °C) water bath so that the concentrator tube is partially immersed in the hot water. Adjust the vertical position of the apparatus and the water temperature as required to complete the concentration in 5 to 10 min. At the proper rate of distillation the balls of the column will actively chatter but the chambers will not flood. When the apparent volume of liquid reaches about 0.5 mL, remove the K-D apparatus and allow it to drain and cool for at least 10 min. Remove the micro-Snyder column and rinse its lower joint into the concentrator tube with 0.2 mL of methanol. Adjust the final volume to 2.0 mL.

12.5 If the internal standard calibration procedure is being used, the internal standard must be added to the sample extract and mixed thoroughly immediately before injection into the gas chromatograph.

12.6 Inject 2 to 5 µL of the sample extract or standard into the gas chromatograph using the solvent-flush technique.²¹ Smaller (1.0 µL) volumes may be injected if automatic devices are employed. Record the volume injected to the nearest 0.05 µL, and the resulting peak size in area or peak height units.

12.7 Identify the parameters in the sample by comparing the retention times of the peaks in the sample chromatogram with those of the peaks in standard chromatograms. The width of the retention time window used to make identifications should be based upon measurements of actual retention time variations of standards over the course of a day. Three times the standard deviation of a retention time for a compound can be used to calculate a suggested window size; however, the experience of the analyst should weigh heavily in the interpretation of chromatograms.

12.8 If the response for a peak exceeds the working range of the system, dilute the extract and reanalyze.

12.9 If the measurement of the peak response is prevented by the presence of interferences, further cleanup is required.

13. Calculations

13.1 Determine the concentration of individual compounds in the sample.

13.1.1 If the external standard calibration procedure is used, calculate the amount of material injected from the peak response

using the calibration curve or calibration factor determined in Section 7.2.2. The concentration in the sample can be calculated from Equation 2.

$$\text{Concentration } (\mu\text{g/L}) = \frac{(A)(V_t)}{(V_i)(V_s)}$$

Equation 2

where:

A=Amount of material injected (ng).

V_i=Volume of extract injected (µL).

V_t=Volume of total extract (µL).

V_s=Volume of water extracted (mL).

13.1.2 If the internal standard calibration procedure is used, calculate the concentration in the sample using the response factor (RF) determined in Section 7.3.2 and Equation 3.

$$\text{RF} = \frac{(A_s)(C_{is})}{(A_{is})(C_s)}$$

Equation 3

where:

A_s=Response for the parameter to be measured.

A_{is}=Response for the internal standard.

I_s=Amount of internal standard added to each extract (µg).

V_s=Volume of water extracted (L).

13.2 Report results in µg/L without correction for recovery data. All QC data obtained should be reported with the sample results.

14. Method Performance

14.1 The method detection limit (MDL) is defined as the minimum concentration of a substance that can be measured and reported with 99% confidence that the value is above zero.³ The MDL concentrations listed in Table 1 were obtained using reagent water.²² Similar results were achieved using representative wastewaters. The MDL actually achieved in a given analysis will vary depending on instrument sensitivity and matrix effects.

14.2 This method has been tested for linearity of spike recovery from reagent water and has been demonstrated to be applicable over the concentration range from 4 × MDL to 1000 × MDL.²²

14.3 This method was tested by 17 laboratories using reagent water, drinking water, surface water, and three industrial wastewaters spiked at six concentrations over the range 0.8 to 55 µg/L.²³ Single operator precision, overall precision, and method accuracy were found to be directly related to the concentration of the parameter and essentially independent of the sample matrix. Linear equations to describe these relationships are presented in Table 3.

References

1. Fine, D.H., Lieb, D., and Ruffeh, R. "Principle of Operation of the Thermal Energy Analyzer for the Trace Analysis of Volatile and Non-volatile N-nitroso Compounds," *Journal of Chromatography*, 107, 351 (1975).
2. Fine, D.H., Hoffman, F., Rounbehler, D.P., and Belcher, N.M. "Analysis of N-nitroso Compounds by Combined High Performance Liquid Chromatography and Thermal Energy Analysis," Walker, E.A., Bogovski, P. and Griecute, L., Editors, N-nitroso Compounds—Analysis and Formation, Lyon, International Agency for Research on Cancer (IARC Scientific Publications No. 14), pp. 43-50 (1976).
3. 40 CFR part 136, appendix B.
4. "Determination of Nitrosamines in Industrial and Municipal Wastewaters," EPA 600/4-82-016, National Technical Information Service, PB82-199621, Springfield, Virginia 22161, April 1982.
5. ASTM Annual Book of Standards, Part 31, D3694-78. "Standard Practices for Preparation of Sample Containers and for Preservation of Organic Constituents," American Society for Testing and Materials, Philadelphia.
6. Buglass, A.J., Challis, B.C., and Osborn, M.R. "Transnitrosation and Decomposition of Nitrosamines," Bogovski, P. and Walker, E.A., Editors, N-nitroso Compounds in the Environment, Lyon, International Agency for Research on Cancer (IARC Scientific Publication No. 9), pp. 94-100 (1974).
7. Burgess, E.M., and Lavanish, J.M. "Photochemical Decomposition of N-nitrosamines," *Tetrahedron Letters*, 1221 (1964)
8. Druckrey, H., Preussmann, R., Ivankovic, S., and Schmahl, D. "Organotrope Carcinogene Wirkungen bei 65 Verschiedenen N-Nitrosoverbindungen an BD-Ratten," *Z. Krebsforsch.*, 69, 103 (1967).
9. Fiddler, W. "The Occurrence and Determination of N-nitroso Compounds," *Toxicol. Appl. Pharmacol.*, 31, 352 (1975).
10. "Carcinogens—Working With Carcinogens," Department of Health, Education, and Welfare, Public Health Service, Center for Disease Control, National Institute for Occupational Safety and Health, Publication No. 77-206, August 1977.
11. "OSHA Safety and Health Standards, General Industry," (29 CFR Part 1910), Occupational Safety and Health Administration, OSHA 2206 (Revised, January 1976).
12. "Safety in Academic Chemistry Laboratories," American Chemical Society Publication, Committee on Chemical Safety, 3rd Edition, 1979.
13. Lijinsky, W. "How Nitrosamines Cause Cancer," *New Scientist*, 73, 216 (1977).
14. Mirvish, S.S. "N-Nitroso compounds: Their Chemical and in vivo Formation and Possible Importance as Environmental Carcinogens," *J. Toxicol. Environ. Health*, 3, 1267 (1977).
15. "Reconnaissance of Environmental Levels of Nitrosamines in the Central United States," EPA-330/1-77-001, National Enforcement Investigations Center, U.S. Environmental Protection Agency (1977).
16. "Atmospheric Nitrosamine Assessment Report," Office of Air Quality Planning and Standards, U.S. Environmental Protection Agency, Research Triangle Park, North Carolina (1976).
17. "Scientific and Technical Assessment Report on Nitrosamines," EPA-660/6-7-001, Office of Research and Development, U.S. Environmental Protection Agency (1976).
18. Provost, L.P., and Elder, R.S. "Interpretation of Percent Recovery Data," *American Laboratory*, 15, 58-63 (1983). (The value 2.44 used in the equation in Section 8.3.3 is two times the value of 1.22 derived in this report.)
19. ASTM Annual Book of Standards, Part 31, D3370-76. "Standard Practices for Sampling Water," American Society for Testing and Materials, Philadelphia.
20. "Methods 330.4 (Titrimetric, DPD-FAS) and 330.5 (Spectrophotometric, DPD) for Chlorine, Total Residual," Methods for Chemical Analysis of Water and Wastes, EPA-600/4-79-020, U.S. Environmental Protection Agency, Environmental Monitoring and Support Laboratory, Cincinnati, Ohio 45268, March 1979.
21. Burke, J. A. "Gas Chromatography for Pesticide Residue Analysis; Some Practical Aspects," *Journal of the Association of Official Analytical Chemists*, 48, 1037 (1965).
22. "Method Detection Limit and Analytical Curve Studies EPA Methods 606, 607, and 608," Special letter report for EPA Contract 68-03-2606, U.S. Environmental Protection Agency, Environmental Monitoring and Support Laboratory, Cincinnati, Ohio 45268, June 1980.
23. "EPA Method Study 17 Method 607—Nitrosamines," EPA 600/4-84-051, National Technical Information Service, PB84-207646, Springfield, Virginia 22161, June 1984.

TABLE 1—CHROMATOGRAPHIC CONDITIONS AND METHOD DETECTION LIMITS

| Parameter | Retention time (min) | | Method detection limit (µg/L) |
|---------------------------------|----------------------|----------|-------------------------------|
| | Column 1 | Column 2 | |
| N-Nitrosodimethylamine | 4.1 | 0.88 | 0.15 |
| N-Nitrosodi-n-propylamine | 12.1 | 4.2 | .46 |

TABLE 1—CHROMATOGRAPHIC CONDITIONS AND METHOD DETECTION LIMITS—Continued

| Parameter | Retention time (min) | | Method detection limit (µg/L) |
|---|----------------------|------------------|-------------------------------|
| | Column 1 | Column 2 | |
| N-Nitrosodiphenylamine ^a | ^b 12.8 | ^c 6.4 | .81 |

Column 1 conditions: Chromosorb W-AW (80/100 mesh) coated with 10% Carbowax 20 M/2% KOH packed in a 1.8 m long × 4mm ID glass column with helium carrier gas at 40 mL/min flow rate. Column temperature held isothermal at 110 °C, except where otherwise indicated.

Column 2 conditions: Supelcoport (100/120 mesh) coated with 10% SP-2250 packed in a 1.8 m long × 4 mm ID glass column with helium carrier gas at 40 mL/min flow rate. Column temperature held isothermal at 120 °C, except where otherwise indicated.

^a Measured as diphenylamine.

^b 220 °C column temperature.

^c 210 °C column temperature.

TABLE 2—QC ACCEPTANCE CRITERIA—METHOD 607

| Parameter | Test conc. (µg/L) | Limit for s (µg/L) | Range for \bar{X} (µg/L) | Range for P, P _s (percent) |
|---------------------------------|-------------------|--------------------|----------------------------|---------------------------------------|
| N-Nitrosodimethylamine | 20 | 3.4 | 4.6–20.0 | 13–109 |
| N-Nitrosodiphenyl | 20 | 6.1 | 2.1–24.5 | D–139 |
| N-Nitrosodi-n-propylamine | 20 | 5.7 | 11.5–26.8 | 45–146 |

s=Standard deviation for four recovery measurements, in µg/L (Section 8.2.4).

\bar{X} =Average recovery for four recovery measurements, in µg/L (Section 8.2.4).

P, P_s=Percent recovery measured (Section 8.3.2, Section 8.4.2).

D=Detected; result must be greater than zero.

NOTE: These criteria are based directly upon the method performance data in Table 3. Where necessary, the limits for recovery have been broadened to assure applicability of the limits to concentrations below those used to develop Table 3.

TABLE 3—METHOD ACCURACY AND PRECISION AS FUNCTIONS OF CONCENTRATION—METHOD 607

| Parameter | Accuracy, as recovery, X' (µg/L) | Single analyst precision, s _r ' (µg/L) | Overall precision, S' (µg/L) |
|---------------------------------|----------------------------------|---|------------------------------|
| N-Nitrosodimethylamine | 0.37C+0.06 | 0.25 \bar{X} – 0.04 | 0.25 \bar{X} +0.11 |
| N-Nitrosodiphenylamine | 0.64C+0.52 | 0.36 \bar{X} – 1.53 | 0.46 \bar{X} – 0.47 |
| N-Nitrosodi-n-propylamine | 0.96C – 0.07 | 0.15 \bar{X} +0.13 | 0.21 \bar{X} +0.15 |

X'=Expected recovery for one or more measurements of a sample containing a concentration of C, in µg/L.

s_r'=Expected single analyst standard deviation of measurements at an average concentration found of \bar{X} , in µg/L.

S'=Expected interlaboratory standard deviation of measurements at an average concentration found of \bar{X} , in µg/L.

C=True value for the concentration, in µg/L.

\bar{X} =Average recovery found for measurements of samples containing a concentration of C, in µg/L.

COLUMN: 10% CARBOWAX 20M / 2% KOH ON CHROMOSORB W-AW
TEMPERATURE: 110°C
DETECTOR: PHOSPHORUS/NITROGEN

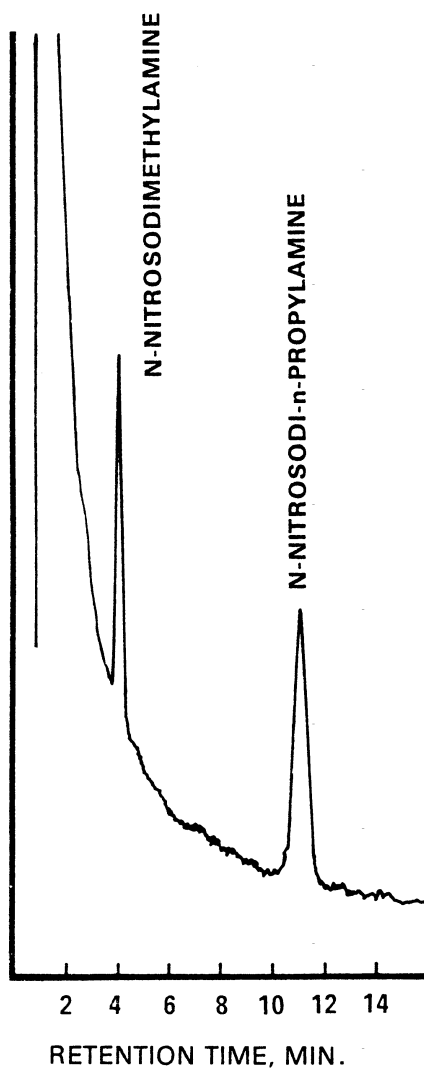

Figure 1. Gas chromatogram of nitrosamines.

COLUMN: 10% CARBOWAX 20M / 2% KOH ON CHROMOSORB W-AW
TEMPERATURE: 220°C
DETECTOR: PHOSPHORUS/NITROGEN

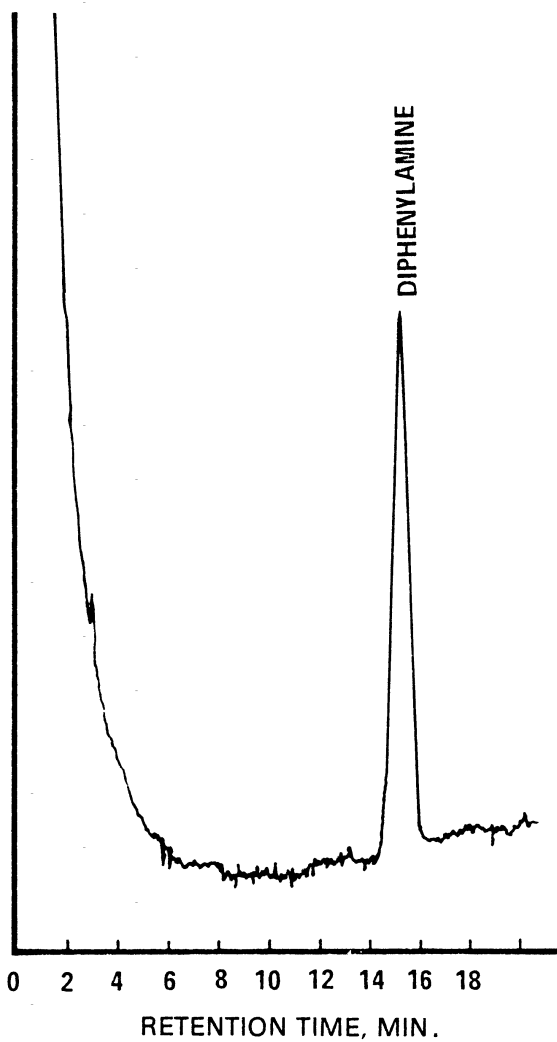

Figure 2. Gas chromatogram of N-nitrosodiphenylamine as diphenylamine.

Environmental Protection Agency

Pt. 136, App. A, Meth. 608

METHOD 608—ORGANOCHLORINE PESTICIDES AND PCBs

1. Scope and Application

1.1 This method covers the determination of certain organochlorine pesticides and PCBs. The following parameters can be determined by this method:

| Parameter | STORET No. | CAS No. |
|--------------------------|------------|------------|
| Aldrin | 39330 | 309-00-2 |
| α -BHC | 39337 | 319-84-6 |
| β -BHC | 39338 | 319-85-7 |
| δ -BHC | 34259 | 319-86-8 |
| γ -BHC | 39340 | 58-89-9 |
| Chlordane | 39350 | 57-74-9 |
| 4,4'-DDD | 39310 | 72-54-8 |
| 4,4'-DDE | 39320 | 72-55-9 |
| 4,4'-DDT | 39300 | 50-29-3 |
| Dieldrin | 39380 | 60-57-1 |
| Endosulfan I | 34361 | 959-98-8 |
| Endosulfan II | 34356 | 33212-65-9 |
| Endosulfan sulfate | 34351 | 1031-07-8 |
| Eldrin | 39390 | 72-20-8 |
| Endrin aldehyde | 34366 | 7421-93-4 |
| Heptachlor | 39410 | 76-44-8 |
| Heptachlor epoxide | 39420 | 1024-57-3 |
| Toxaphene | 39400 | 8001-35-2 |
| PCB-1016 | 34671 | 12674-11-2 |
| PCB-1221 | 39488 | 1104-28-2 |
| PCB-1232 | 39492 | 11141-16-5 |
| PCB-1242 | 39496 | 53469-21-9 |
| PCB-1248 | 39500 | 12672-29-6 |
| PCB-1254 | 39504 | 11097-69-1 |
| PCB-1260 | 39508 | 11096-82-5 |

1.2 This is a gas chromatographic (GC) method applicable to the determination of the compounds listed above in municipal and industrial discharges as provided under 40 CFR 136.1. When this method is used to analyze unfamiliar samples for any or all of the compounds above, compound identifications should be supported by at least one additional qualitative technique. This method describes analytical conditions for a second gas chromatographic column that can be used to confirm measurements made with the primary column. Method 625 provides gas chromatograph/mass spectrometer (GC/MS) conditions appropriate for the qualitative and quantitative confirmation of results for all of the parameters listed above, using the extract produced by this method.

1.3 The method detection limit (MDL, defined in Section 14.1)¹ for each parameter is listed in Table 1. The MDL for a specific wastewater may differ from those listed, depending upon the nature of interferences in the sample matrix.

1.4 The sample extraction and concentration steps in this method are essentially the same as in Methods 606, 609, 611, and 612. Thus, a single sample may be extracted to measure the parameters included in the scope of each of these methods. When cleanup is required, the concentration levels must be high enough to permit selecting aliquots, as necessary, to apply appropriate cleanup

procedures. The analyst is allowed the latitude, under Section 12, to select chromatographic conditions appropriate for the simultaneous measurement of combinations of these parameters.

1.5 Any modification of this method, beyond those expressly permitted, shall be considered as a major modification subject to application and approval of alternate test procedures under 40 CFR 136.4 and 136.5.

1.6 This method is restricted to use by or under the supervision of analysts experienced in the use of a gas chromatograph and in the interpretation of gas chromatograms. Each analyst must demonstrate the ability to generate acceptable results with this method using the procedure described in Section 8.2.

2. Summary of Method

2.1 A measured volume of sample, approximately 1-L, is extracted with methylene chloride using a separatory funnel. The methylene chloride extract is dried and exchanged to hexane during concentration to a volume of 10 mL or less. The extract is separated by gas chromatography and the parameters are then measured with an electron capture detector.²

2.2 The method provides a Florisil column cleanup procedure and an elemental sulfur removal procedure to aid in the elimination of interferences that may be encountered.

3. Interferences

3.1 Method interferences may be caused by contaminants in solvents, reagents, glassware, and other sample processing hardware that lead to discrete artifacts and/or elevated baselines in gas chromatograms. All of these materials must be routinely demonstrated to be free from interferences under the conditions of the analysis by running laboratory reagent blanks as described in Section 8.1.3.

3.1.1 Glassware must be scrupulously cleaned.³ Clean all glassware as soon as possible after use by rinsing with the last solvent used in it. Solvent rinsing should be followed by detergent washing with hot water, and rinses with tap water and distilled water. The glassware should then be drained dry, and heated in a muffle furnace at 400 °C for 15 to 30 min. Some thermally stable materials, such as PCBs, may not be eliminated by this treatment. Solvent rinses with acetone and pesticide quality hexane may be substituted for the muffle furnace heating. Thorough rinsing with such solvents usually eliminates PCB interference. Volumetric ware should not be heated in a muffle furnace. After drying and cooling, glassware should be sealed and stored in a clean environment to prevent any accumulation of dust or other contaminants. Store inverted or capped with aluminum foil.

3.1.2 The use of high purity reagents and solvents helps to minimize interference problems. Purification of solvents by distillation in all-glass systems may be required.

3.2 Interferences by phthalate esters can pose a major problem in pesticide analysis when using the electron capture detector. These compounds generally appear in the chromatogram as large late eluting peaks, especially in the 15 and 50% fractions from Florisil. Common flexible plastics contain varying amounts of phthalates. These phthalates are easily extracted or leached from such materials during laboratory operations. Cross contamination of clean glassware routinely occurs when plastics are handled during extraction steps, especially when solvent-wetted surfaces are handled. Interferences from phthalates can best be minimized by avoiding the use of plastics in the laboratory. Exhaustive cleanup of reagents and glassware may be required to eliminate background phthalate contamination.^{4,5} The interferences from phthalate esters can be avoided by using a microcoulometric or electrolytic conductivity detector.

3.3 Matrix interferences may be caused by contaminants that are co-extracted from the sample. The extent of matrix interferences will vary considerably from source to source, depending upon the nature and diversity of the industrial complex or municipality being sampled. The cleanup procedures in Section 11 can be used to overcome many of these interferences, but unique samples may require additional cleanup approaches to achieve the MDL listed in Table 1.

4. Safety

4.1 The toxicity or carcinogenicity of each reagent used in this method has not been precisely defined; however, each chemical compound should be treated as a potential health hazard. From this viewpoint, exposure to these chemicals must be reduced to the lowest possible level by whatever means available. The laboratory is responsible for maintaining a current awareness file of OSHA regulations regarding the safe handling of the chemicals specified in this method. A reference file of material data handling sheets should also be made available to all personnel involved in the chemical analysis. Additional references to laboratory safety are available and have been identified⁶⁻⁸ for the information of the analyst.

4.2 The following parameters covered by this method have been tentatively classified as known or suspected, human or mammalian carcinogens: 4,4'-DDT, 4,4'-DDD, the BHCs, and the PCBs. Primary standards of these toxic compounds should be prepared in a hood. A NIOSH/MESA approved toxic gas respirator should be worn when the analyst handles high concentrations of these toxic compounds.

5. Apparatus and Materials

5.1 Sampling equipment, for discrete or composite sampling.

5.1.1 Grab sample bottle—1-L or 1-qt, amber glass, fitted with a screw cap lined with Teflon. Foil may be substituted for Teflon if the sample is not corrosive. If amber bottles are not available, protect samples from light. The bottle and cap liner must be washed, rinsed with acetone or methylene chloride, and dried before use to minimize contamination.

5.1.2 Automatic sampler (optional)—The sampler must incorporate glass sample containers for the collection of a minimum of 250 mL of sample. Sample containers must be kept refrigerated at 4 °C and protected from light during composting. If the sampler uses a peristaltic pump, a minimum length of compressible silicone rubber tubing may be used. Before use, however, the compressible tubing should be thoroughly rinsed with methanol, followed by repeated rinsings with distilled water to minimize the potential for contamination of the sample. An integrating flow meter is required to collect flow proportional composites.

5.2. Glassware (All specifications are suggested. Catalog numbers are included for illustration only.):

5.2.1 Separatory funnel—2-L, with Teflon stopcock.

5.2.2 Drying column—Chromatographic column, approximately 400 mm long × 19 mm ID, with coarse frit filter disc.

5.2.3 Chromatographic column—400 mm long × 22 mm ID, with Teflon stopcock and coarse frit filter disc (Kontes K-42054 or equivalent).

5.2.4 Concentrator tube, Kuderna-Danish—10-mL, graduated (Kontes K-570050-1025 or equivalent). Calibration must be checked at the volumes employed in the test. Ground glass stopper is used to prevent evaporation of extracts.

5.2.5 Evaporative flask, Kuderna-Danish—500-mL (Kontes K-570001-0500 or equivalent). Attach to concentrator tube with springs.

5.2.6 Snyder column, Kuderna/Danish—Three-ball macro (Kontes K-503000-0121 or equivalent).

5.2.7 Vials—10 to 15-mL, amber glass, with Teflon-lined screw cap.

5.3 Boiling chips—Approximately 10/40 mesh. Heat to 400 °C for 30 min or Soxhlet extract with methylene chloride.

5.4 Water bath—Heated, with concentric ring cover, capable of temperature control (±2 °C). The bath should be used in a hood.

5.5 Balance—Analytical, capable of accurately weighing 0.0001 g.

5.6 Gas chromatograph—An analytical system complete with gas chromatograph suitable for on-column injection and all required accessories including syringes, analytical columns, gases, detector, and strip-

chart recorder. A data system is recommended for measuring peak areas.

5.6.1 Column 1—1.8 m long \times 4 mm ID glass, packed with 1.5% SP-2250/1.95% SP-2401 on Supelcoport (100/120 mesh) or equivalent. This column was used to develop the method performance statements in Section 14. Guidelines for the use of alternate column packings are provided in Section 12.1.

5.6.2 Column 2—1.8 m long \times 4 mm ID glass, packed with 3% OV-1 on Supelcoport (100/120 mesh) or equivalent.

5.6.3 Detector—Electron capture detector. This detector has proven effective in the analysis of wastewaters for the parameters listed in the scope (Section 1.1), and was used to develop the method performance statements in Section 14. Guidelines for the use of alternate detectors are provided in Section 12.1.

6. Reagents

6.1 Reagent water—Reagent water is defined as a water in which an interferent is not observed at the MDL of the parameters of interest.

6.2 Sodium hydroxide solution (10 N)—Dissolve 40 g of NaOH (ACS) in reagent water and dilute to 100 mL.

6.3 Sodium thiosulfate—(ACS) Granular.

6.4 Sulfuric acid (1+1)—Slowly, add 50 mL to H₂SO₄ (ACS, sp. gr. 1.84) to 50 mL of reagent water.

6.5 Acetone, hexane, isooctane, methylene chloride—Pesticide quality or equivalent.

6.6 Ethyl ether—Nanograde, redistilled in glass if necessary.

6.6.1 Ethyl ether must be shown to be free of peroxides before it is used as indicated by EM Laboratories Quant test strips. (Available from Scientific Products Co., Cat. No. PL126-8, and other suppliers.)

6.6.2 Procedures recommended for removal of peroxides are provided with the test strips. After cleanup, 20 mL of ethyl alcohol preservative must be added to each liter of ether.

6.7 Sodium sulfate—(ACS) Granular, anhydrous. Purify by heating at 400 °C for 4 h in a shallow tray.

6.8 Florisil—PR grade (60/100 mesh). Purchase activated at 1250 °F and store in the dark in glass containers with ground glass stoppers or foil-lined screw caps. Before use, activate each batch at least 16 h at 130 °C in a foil-covered glass container and allow to cool.

6.9 Mercury—Triple distilled.

6.10 Copper powder—Activated.

6.11 Stock standard solutions (1.00 µg/µL)—Stock standard solutions can be prepared from pure standard materials or purchased as certified solutions.

6.11.1 Prepare stock standard solutions by accurately weighing about 0.0100 g of pure material. Dissolve the material in isooctane and dilute to volume in a 10-mL volumetric

flask. Larger volumes can be used at the convenience of the analyst. When compound purity is assayed to be 96% or greater, the weight can be used without correction to calculate the concentration of the stock standard. Commercially prepared stock standards can be used at any concentration if they are certified by the manufacturer or by an independent source.

6.11.2 Transfer the stock standard solutions into Teflon-sealed screw-cap bottles. Store at 4 °C and protect from light. Stock standard solutions should be checked frequently for signs of degradation or evaporation, especially just prior to preparing calibration standards from them.

6.11.3 Stock standard solutions must be replaced after six months, or sooner if comparison with check standards indicates a problem.

6.12 Quality control check sample concentrate—See Section 8.2.1.

7. Calibration

7.1 Establish gas chromatographic operating conditions equivalent to those given in Table 1. The gas chromatographic system can be calibrated using the external standard technique (Section 7.2) or the internal standard technique (Section 7.3).

7.2 External standard calibration procedure:

7.2.1 Prepare calibration standards at a minimum of three concentration levels for each parameter of interest by adding volumes of one or more stock standards to a volumetric flask and diluting to volume with isooctane. One of the external standards should be at a concentration near, but above, the MDL (Table 1) and the other concentrations should correspond to the expected range of concentrations found in real samples or should define the working range of the detector.

7.2.2 Using injections of 2 to 5 µL, analyze each calibration standard according to Section 12 and tabulate peak height or area responses against the mass injected. The results can be used to prepare a calibration curve for each compound. Alternatively, if the ratio of response to amount injected (calibration factor) is a constant over the working range (<10% relative standard deviation, RSD), linearity through the origin can be assumed and the average ratio or calibration factor can be used in place of a calibration curve.

7.3 Internal standard calibration procedure—To use this approach, the analyst must select one or more internal standards that are similar in analytical behavior to the compounds of interest. The analyst must further demonstrate that the measurement of the internal standard is not affected by method or matrix interferences. Because of these limitations, no internal standard can

be suggested that is applicable to all samples.

7.3.1 Prepare calibration standards at a minimum of three concentration levels for each parameter of interest by adding volumes of one or more stock standards to a volumetric flask. To each calibration standard, add a known constant amount of one or more internal standards, and dilute to volume with isooctane. One of the standards should be at a concentration near, but above, the MDL and the other concentrations should correspond to the expected range of concentrations found in real samples or should define the working range of the detector.

7.3.2 Using injections of 2 to 5 μ L, analyze each calibration standard according to Section 12 and tabulate peak height or area responses against concentration for each compound and internal standard. Calculate response factors (RF) for each compound using Equation 1.

$$RF = \frac{(A_s)(C_{is})}{(A_{is})(C_s)}$$

Equation 1

where:

A_s =Response for the parameter to be measured.

A_{is} =Response for the internal standard.

C_{is} =Concentration of the internal standard (μ g/L).

C_s =Concentration of the parameter to be measured (μ g/L).

If the RF value over the working range is a constant (<10% RSD), the RF can be assumed to be invariant and the average RF can be used for calculations. Alternatively, the results can be used to plot a calibration curve of response ratios, A_s/A_{is} , vs. RF.

7.4 The working calibration curve, calibration factor, or RF must be verified on each working day by the measurement of one or more calibration standards. If the response for any parameter varies from the predicted response by more than $\pm 15\%$, the test must be repeated using a fresh calibration standard. Alternatively, a new calibration curve must be prepared for that compound.

7.5 The cleanup procedure in Section 11 utilizes Florisil column chromatography. Florisil from different batches or sources may vary in adsorptive capacity. To standardize the amount of Florisil which is used, the use of lauric acid value⁹ is suggested. The referenced procedure determines the adsorption from hexane solution of lauric acid (mg) per g of Florisil. The amount of Florisil to be used for each column is calculated by dividing 110 by this ratio and multiplying by 20 g.

7.6 Before using any cleanup procedure, the analyst must process a series of calibra-

tion standards through the procedure to validate elution patterns and the absence of interferences from the reagents.

8. Quality Control

8.1 Each laboratory that uses this method is required to operate a formal quality control program. The minimum requirements of this program consist of an initial demonstration of laboratory capability and an ongoing analysis of spiked samples to evaluate and document data quality. The laboratory must maintain records to document the quality of data that is generated. Ongoing data quality checks are compared with established performance criteria to determine if the results of analyses meet the performance characteristics of the method. When results of sample spikes indicate atypical method performance, a quality control check standard must be analyzed to confirm that the measurements were performed in an in-control mode of operation.

8.1.1 The analyst must make an initial, one-time, demonstration of the ability to generate acceptable accuracy and precision with this method. This ability is established as described in Section 8.2.

8.1.2 In recognition of advances that are occurring in chromatography, the analyst is permitted certain options (detailed in Sections 10.4, 11.1, and 12.1) to improve the separations or lower the cost of measurements. Each time such a modification is made to the method, the analyst is required to repeat the procedure in Section 8.2.

8.1.3 Before processing any samples, the analyst must analyze a reagent water blank to demonstrate that interferences from the analytical system and glassware are under control. Each time a set of samples is extracted or reagents are changed, a reagent water blank must be processed as a safeguard against laboratory contamination.

8.1.4 The laboratory must, on an ongoing basis, spike and analyze a minimum of 10% of all samples to monitor and evaluate laboratory data quality. This procedure is described in Section 8.3.

8.1.5 The laboratory must, on an ongoing basis, demonstrate through the analyses of quality control check standards that the operation of the measurement system is in control. This procedure is described in Section 8.4. The frequency of the check standard analyses is equivalent to 10% of all samples analyzed but may be reduced if spike recoveries from samples (Section 8.3) meet all specified quality control criteria.

8.1.6 The laboratory must maintain performance records to document the quality of data that is generated. This procedure is described in Section 8.5.

8.2 To establish the ability to generate acceptable accuracy and precision, the analyst must perform the following operations.

8.2.1 A quality control (QC) check sample concentrate is required containing each single-component parameter of interest at the following concentrations in acetone: 4,4'-DDD, 10 µg/mL; 4,4'-DDT, 10 µg/mL; endosulfan II, 10 µg/mL; endosulfan sulfate, 10 µg/mL; endrin, 10 µg/mL; any other single-component pesticide, 2 µg/mL. If this method is only to be used to analyze for PCBs, chlordane, or toxaphene, the QC check sample concentrate should contain the most representative multicomponent parameter at a concentration of 50 µg/mL in acetone. The QC check sample concentrate must be obtained from the U.S. Environmental Protection Agency, Environmental Monitoring and Support Laboratory in Cincinnati, Ohio, if available. If not available from that source, the QC check sample concentrate must be obtained from another external source. If not available from either source above, the QC check sample concentrate must be prepared by the laboratory using stock standards prepared independently from those used for calibration.

8.2.2 Using a pipet, prepare QC check samples at the test concentrations shown in Table 3 by adding 1.00 mL of QC check sample concentrate to each of four 1-L aliquots of reagent water.

8.2.3 Analyze the well-mixed QC check samples according to the method beginning in Section 10.

8.2.4 Calculate the average recovery (\bar{X}) in µg/mL; and the standard deviation of the recovery (s) in µg/mL, for each parameter using the four results.

8.2.5 For each parameter compare s and \bar{X} with the corresponding acceptance criteria for precision and accuracy, respectively, found in Table 3. If s and \bar{X} for all parameters of interest meet the acceptance criteria, the system performance is acceptable and analysis of actual samples can begin. If any individual s exceeds the precision limit or any individual \bar{X} falls outside the range for accuracy, the system performance is unacceptable for that parameter.

NOTE: The large number of parameters in Table 3 present a substantial probability that one or more will fail at least one of the acceptance criteria when all parameters are analyzed.

8.2.6 When one or more of the parameters tested fail at least one of the acceptance criteria, the analyst must proceed according to Section 8.2.6.1 or 8.2.6.2.

8.2.6.1 Locate and correct the source of the problem and repeat the test for all parameters of interest beginning with Section 8.2.2.

8.2.6.2 Beginning with Section 8.2.2, repeat the test only for those parameters that failed to meet criteria. Repeated failure, however, will confirm a general problem with the measurement system. If this occurs, locate and correct the source of the problem

and repeat the test for all compounds of interest beginning with Section 8.2.2.

8.3 The laboratory must, on an ongoing basis, spike at least 10% of the samples from each sample site being monitored to assess accuracy. For laboratories analyzing one to ten samples per month, at least one spiked sample per month is required.

8.3.1 The concentration of the spike in the sample should be determined as follows:

8.3.1.1 If, as in compliance monitoring, the concentration of a specific parameter in the sample is being checked against a regulatory concentration limit, the spike should be at that limit or 1 to 5 times higher than the background concentration determined in Section 8.3.2, whichever concentration would be larger.

8.3.1.2 If the concentration of a specific parameter in the sample is not being checked against a limit specific to that parameter, the spike should be at the test concentration in Section 8.2.2 or 1 to 5 times higher than the background concentration determined in Section 8.3.2, whichever concentration would be larger.

8.3.1.3 If it is impractical to determine background levels before spiking (e.g., maximum holding times will be exceeded), the spike concentration should be (1) the regulatory concentration limit, if any; or, if none (2) the larger of either 5 times higher than the expected background concentration or the test concentration in Section 8.2.2.

8.3.2 Analyze one sample aliquot to determine the background concentration (B) of each parameter. If necessary, prepare a new QC check sample concentrate (Section 8.2.1) appropriate for the background concentrations in the sample. Spike a second sample aliquot with 1.0 mL of the QC check sample concentrate and analyze it to determine the concentration after spiking (A) of each parameter. Calculate each percent recovery (P) as $100(A-B)/T$, where T is the known true value of the spike.

8.3.3 Compare the percent recovery (P) for each parameter with the corresponding QC acceptance criteria found in Table 3. These acceptance criteria were calculated to include an allowance for error in measurement of both the background and spike concentrations, assuming a spike to background ratio of 5:1. This error will be accounted for to the extent that the analyst's spike to background ratio approaches 5:1.¹⁰ If spiking was performed at a concentration lower than the test concentration in Section 8.2.2, the analyst must use either the QC acceptance criteria in Table 3, or optional QC acceptance criteria calculated for the specific spike concentration. To calculate optional acceptance criteria for the recovery of a parameter: (1) Calculate accuracy (X') using the equation in Table 4, substituting the spike concentration (T) for C; (2) calculate overall precision (S') using the equation in Table 4, substituting X'

for \bar{X} ; (3) calculate the range for recovery at the spike concentration as $(100 X/T) \pm 2.44(100 S/T)\%$.¹⁰

8.3.4 If any individual P falls outside the designated range for recovery, that parameter has failed the acceptance criteria. A check standard containing each parameter that failed the criteria must be analyzed as described in Section 8.4.

8.4 If any parameter fails the acceptance criteria for recovery in Section 8.3, a QC check standard containing each parameter that failed must be prepared and analyzed.

NOTE: The frequency for the required analysis of a QC check standard will depend upon the number of parameters being simultaneously tested, the complexity of the sample matrix, and the performance of the laboratory. If the entire list of parameters in Table 3 must be measured in the sample in Section 8.3, the probability that the analysis of a QC check standard will be required is high. In this case the QC check standard should be routinely analyzed with the spike sample.

8.4.1 Prepare the QC check standard by adding 1.0 mL of QC check sample concentrate (Section 8.2.1 or 8.3.2) to 1 L of reagent water. The QC check standard needs only to contain the parameters that failed criteria in the test in Section 8.3.

8.4.2 Analyze the QC check standards to determine the concentration measured (A) of each parameter. Calculate each percent recovery (P_s) as $100 (A/T)\%$, where T is the true value of the standard concentration.

8.4.3 Compare the percent recovery (P_s) for each parameter with the corresponding QC acceptance criteria found in Table 3. Only parameters that failed the test in Section 8.3 need to be compared with these criteria. If the recovery of any such parameter falls outside the designated range, the laboratory performance for that parameter is judged to be out of control, and the problem must be immediately identified and corrected. The analytical result for that parameter in the unspiked sample is suspect and may not be reported for regulatory compliance purposes.

8.5 As part of the QC program for the laboratory, method accuracy for wastewater samples must be assessed and records must be maintained. After the analysis of five spiked wastewater samples as in Section 8.3, calculate the average percent recovery (\bar{P}) and the standard deviation of the percent recovery (s_p). Express the accuracy assessment as a percent recovery interval from $\bar{P} - 2 s_p$ to $\bar{P} + 2 s_p$. If $\bar{P}=90\%$ and $s_p=10\%$, for example, the accuracy interval is expressed as 70-110%. Update the accuracy assessment for each parameter on a regular basis (e.g. after each five to ten new accuracy measurements).

8.6 It is recommended that the laboratory adopt additional quality assurance practices for use with this method. The specific practices that are most productive depend upon the needs of the laboratory and the nature of

the samples. Field duplicates may be analyzed to assess the precision of the environmental measurements. When doubt exists over the identification of a peak on the chromatogram, confirmatory techniques such as gas chromatography with a dissimilar column, specific element detector, or mass spectrometer must be used. Whenever possible, the laboratory should analyze standard reference materials and participate in relevant performance evaluation studies.

9. Sample Collection, Preservation, and Handling

9.1 Grab samples must be collected in glass containers. Conventional sampling practices¹¹ should be followed, except that the bottle must not be prerinsed with sample before collection. Composite samples should be collected in refrigerated glass containers in accordance with the requirements of the program. Automatic sampling equipment must be as free as possible of Tygon tubing and other potential sources of contamination.

9.2 All samples must be iced or refrigerated at 4 °C from the time of collection until extraction. If the samples will not be extracted within 72 h of collection, the sample should be adjusted to a pH range of 5.0 to 9.0 with sodium hydroxide solution or sulfuric acid. Record the volume of acid or base used. If aldrin is to be determined, add sodium thiosulfate when residual chlorine is present. EPA Methods 330.4 and 330.5 may be used for measurement of residual chlorine.¹² Field test kits are available for this purpose.

9.3 All samples must be extracted within 7 days of collection and completely analyzed within 40 days of extraction.²

10. Sample Extraction

10.1 Mark the water meniscus on the side of the sample bottle for later determination of sample volume. Pour the entire sample into a 2-L separatory funnel.

10.2 Add 60 mL of methylene chloride to the sample bottle, seal, and shake 30 s to rinse the inner surface. Transfer the solvent to the separatory funnel and extract the sample by shaking the funnel for 2 min. with periodic venting to release excess pressure. Allow the organic layer to separate from the water phase for a minimum of 10 min. If the emulsion interface between layers is more than one-third the volume of the solvent layer, the analyst must employ mechanical techniques to complete the phase separation. The optimum technique depends upon the sample, but may include stirring, filtration of the emulsion through glass wool, centrifugation, or other physical methods. Collect the methylene chloride extract in a 250-mL Erlenmeyer flask.

10.3 Add a second 60-mL volume of methylene chloride to the sample bottle and repeat the extraction procedure a second time, combining the extracts in the Erlenmeyer flask. Perform a third extraction in the same manner.

10.4 Assemble a Kuderna-Danish (K-D) concentrator by attaching a 10-mL concentrator tube to a 500-mL evaporative flask. Other concentration devices or techniques may be used in place of the K-D concentrator if the requirements of Section 8.2 are met.

10.5 Pour the combined extract through a solvent-rinsed drying column containing about 10 cm of anhydrous sodium sulfate, and collect the extract in the K-D concentrator. Rinse the Erlenmeyer flask and column with 20 to 30 mL of methylene chloride to complete the quantitative transfer.

10.6 Add one or two clean boiling chips to the evaporative flask and attach a three-ball Snyder column. Prewet the Snyder column by adding about 1 mL of methylene chloride to the top. Place the K-D apparatus on a hot water bath (60 to 65 °C) so that the concentrator tube is partially immersed in the hot water, and the entire lower rounded surface of the flask is bathed with hot vapor. Adjust the vertical position of the apparatus and the water temperature as required to complete the concentration in 15 to 20 min. At the proper rate of distillation the balls of the column will actively chatter but the chambers will not flood with condensed solvent. When the apparent volume of liquid reaches 1 mL, remove the K-D apparatus and allow it to drain and cool for at least 10 min.

10.7 Increase the temperature of the hot water bath to about 80 °C. Momentarily remove the Snyder column, add 50 mL of hexane and a new boiling chip, and reattach the Snyder column. Concentrate the extract as in Section 10.6, except use hexane to prewet the column. The elapsed time of concentration should be 5 to 10 min.

10.8 Remove the Snyder column and rinse the flask and its lower joint into the concentrator tube with 1 to 2 mL of hexane. A 5-mL syringe is recommended for this operation. Stopper the concentrator tube and store refrigerated if further processing will not be performed immediately. If the extract will be stored longer than two days, it should be transferred to a Teflon-sealed screw-cap vial. If the sample extract requires no further cleanup, proceed with gas chromatographic analysis (Section 12). If the sample requires further cleanup, proceed to Section 11.

10.9 Determine the original sample volume by refilling the sample bottle to the mark and transferring the liquid to a 1000-mL graduated cylinder. Record the sample volume to the nearest 5 mL.

11. Cleanup and Separation

11.1 Cleanup procedures may not be necessary for a relatively clean sample matrix.

If particular circumstances demand the use of a cleanup procedure, the analyst may use either procedure below or any other appropriate procedure. However, the analyst first must demonstrate that the requirements of Section 8.2 can be met using the method as revised to incorporate the cleanup procedure. The Florisil column allows for a select fractionation of the compounds and will eliminate polar interferences. Elemental sulfur, which interferes with the electron capture gas chromatography of certain pesticides, can be removed by the technique described in Section 11.3.

11.2 Florisil column cleanup:

11.2.1 Place a weight of Florisil (nominally 20 g) predetermined by calibration (Section 7.5), into a chromatographic column. Tap the column to settle the Florisil and add 1 to 2 cm of anhydrous sodium sulfate to the top.

11.2.2 Add 60 mL of hexane to wet and rinse the sodium sulfate and Florisil. Just prior to exposure of the sodium sulfate layer to the air, stop the elution of the hexane by closing the stopcock on the chromatographic column. Discard the eluate.

11.2.3 Adjust the sample extract volume to 10 mL with hexane and transfer it from the K-D concentrator tube onto the column. Rinse the tube twice with 1 to 2 mL of hexane, adding each rinse to the column.

11.2.4 Place a 500-mL K-D flask and clean concentrator tube under the chromatographic column. Drain the column into the flask until the sodium sulfate layer is nearly exposed. Elute the column with 200 mL of 6% ethyl ether in hexane (V/V) (Fraction 1) at a rate of about 5 mL/min. Remove the K-D flask and set it aside for later concentration. Elute the column again, using 200 mL of 15% ethyl ether in hexane (V/V) (Fraction 2), into a second K-D flask. Perform the third elution using 200 mL of 50% ethyl ether in hexane (V/V) (Fraction 3). The elution patterns for the pesticides and PCBs are shown in Table 2.

11.2.5 Concentrate the fractions as in Section 10.6, except use hexane to prewet the column and set the water bath at about 85 °C. When the apparatus is cool, remove the Snyder column and rinse the flask and its lower joint into the concentrator tube with hexane. Adjust the volume of each fraction to 10 mL with hexane and analyze by gas chromatography (Section 12).

11.3 Elemental sulfur will usually elute entirely in Fraction 1 of the Florisil column cleanup. To remove sulfur interference from this fraction or the original extract, pipet 1.00 mL of the concentrated extract into a clean concentrator tube or Teflon-sealed vial. Add one to three drops of mercury and seal.¹³ Agitate the contents of the vial for 15 to 30 s. Prolonged shaking (2 h) may be required. If so, this may be accomplished with a reciprocal shaker. Alternatively, activated

copper powder may be used for sulfur removal.¹⁴ Analyze by gas chromatography.

12. Gas Chromatography

12.1 Table 1 summarizes the recommended operating conditions for the gas chromatograph. Included in this table are retention times and MDL that can be achieved under these conditions. Examples of the separations achieved by Column 1 are shown in Figures 1 to 10. Other packed or capillary (open-tubular) columns, chromatographic conditions, or detectors may be used if the requirements of Section 8.2 are met.

12.2 Calibrate the system daily as described in Section 7.

12.3 If the internal standard calibration procedure is being used, the internal standard must be added to the sample extract and mixed thoroughly immediately before injection into the gas chromatograph.

12.4 Inject 2 to 5 μL of the sample extract or standard into the gas chromatograph using the solvent-flush technique.¹⁵ Smaller (1.0 μL) volumes may be injected if automatic devices are employed. Record the volume injected to the nearest 0.05 μL , the total extract volume, and the resulting peak size in area or peak height units.

12.5 Identify the parameters in the sample by comparing the retention times of the peaks in the sample chromatogram with those of the peaks in standard chromatograms. The width of the retention time window used to make identifications should be based upon measurements of actual retention time variations of standards over the course of a day. Three times the standard deviation of a retention time for a compound can be used to calculate a suggested window size; however, the experience of the analyst should weigh heavily in the interpretation of chromatograms.

12.6 If the response for a peak exceeds the working range of the system, dilute the extract and reanalyze.

12.7 If the measurement of the peak response is prevented by the presence of interferences, further cleanup is required.

13. Calculations

13.1 Determine the concentration of individual compounds in the sample.

13.1.1 If the external standard calibration procedure is used, calculate the amount of material injected from the peak response using the calibration curve or calibration factor determined in Section 7.2.2. The concentration in the sample can be calculated from Equation 2.

$$\text{Concentration } (\mu\text{g/L}) = \frac{(A)(V_t)}{(V_i)(V_s)}$$

Equation 2

where:

A=Amount of material injected (ng).

V_i =Volume of extract injected (μL).

V_t =Volume of total extract (μL).

V_s =Volume of water extracted (mL).

13.1.2 If the internal standard calibration procedure is used, calculate the concentration in the sample using the response factor (RF) determined in Section 7.3.2 and Equation 3.

$$\text{Concentration } (\mu\text{g/L}) = \frac{(A_s)(I_s)}{(A_{is})(\text{RF})(V_o)}$$

Equation 3

where:

A_s =Response for the parameter to be measured.

A_{is} =Response for the internal standard.

I_s =Amount of internal standard added to each extract (μg).

V_o =Volume of water extracted (L).

13.2 When it is apparent that two or more PCB (Aroclor) mixtures are present, the Webb and McCall procedure¹⁶ may be used to identify and quantify the Aroclors.

13.3 For multicomponent mixtures (chlordanes, toxaphene, and PCBs) match retention times of peaks in the standards with peaks in the sample. Quantitate every identifiable peak unless interference with individual peaks persist after cleanup. Add peak height or peak area of each identified peak in the chromatogram. Calculate as total response in the sample versus total response in the standard.

13.4 Report results in $\mu\text{g/L}$ without correction for recovery data. All QC data obtained should be reported with the sample results.

14. Method Performance

14.1 The method detection limit (MDL) is defined as the minimum concentration of a substance that can be measured and reported with 99% confidence that the value is above zero.¹ The MDL concentrations listed in Table 1 were obtained using reagent water.¹⁷ Similar results were achieved using representative wastewaters. The MDL actually achieved in a given analysis will vary depending on instrument sensitivity and matrix effects.

14.2 This method has been tested for linearity of spike recovery from reagent water and has been demonstrated to be applicable over the concentration range from 4 \times MDL to 1000 \times MDL with the following exceptions: Chlordanes recovery at 4 \times MDL was low (60%); Toxaphene recovery was demonstrated linear over the range of 10 \times MDL to 1000 \times MDL.¹⁷

14.3 This method was tested by 20 laboratories using reagent water, drinking water, surface water, and three industrial

wastewaters spiked at six concentrations.¹⁸ Concentrations used in the study ranged from 0.5 to 30 µg/L for single-component pesticides and from 8.5 to 400 µg/L for multi-component parameters. Single operator precision, overall precision, and method accuracy were found to be directly related to the concentration of the parameter and essentially independent of the sample matrix. Linear equations to describe these relationships are presented in Table 4.

REFERENCES

- 40 CFR part 136, appendix B.
- "Determination of Pesticides and PCBs in Industrial and Municipal Wastewaters," EPA 600/4-82-023, National Technical Information Service, PB82-214222, Springfield, Virginia 22161, April 1982.
- ASTM Annual Book of Standards, Part 31, D3694-78. "Standard Practices for Preparation of Sample Containers and for Preservation of Organic Constituents," American Society for Testing and Materials, Philadelphia.
- Giam, C.S., Chan, H.S., and Nef, G.S., "Sensitive Method for Determination of Phthalate Ester Plasticizers in Open-Ocean Biota Samples," *Analytical Chemistry*, 47, 2225 (1975).
- Giam, C.S., Chan, H.S. "Control of Blanks in the Analysis of Phthalates in Air and Ocean Biota Samples," U.S. National Bureau of Standards, Special Publication 442, pp. 701-708, 1976.
- "Carcinogens—Working With Carcinogens," Department of Health, Education, and Welfare, Public Health Service, Center for Disease Control, National Institute for Occupational Safety and Health, Publication No. 77-206, August 1977.
- "OSHA Safety and Health Standards, General Industry," (29 CFR part 1910), Occupational Safety and Health Administration, OSHA 2206 (Revised, January 1976).
- "Safety in Academic Chemistry Laboratories," American Chemical Society Publication, Committee on Chemical Safety, 3rd Edition, 1979.
- Mills, P.A. "Variation of Florisil Activity: Simple Method for Measuring Absorbent Capacity and Its Use in Standardizing Florisil Columns," *Journal of the Association of Official Analytical Chemists*, 51, 29, (1968).
- Provost, L.P., and Elder, R.S. "Interpretation of Percent Recovery Data," *American Laboratory*, 15, 58-63 (1983). (The value 2.44 used in the equation in Section 8.3.3 is two times the value 1.22 derived in this report.)
- ASTM Annual Book of Standards, Part 31, D3370-76. "Standard Practices for Sampling Water," American Society for Testing and Materials, Philadelphia.
- "Methods 330.4 (Titrimetric, DPD-FAS) and 330.5 (Spectrophotometric, DPD) for Chlorine, Total Residual," Methods for Chemical Analysis of Water and Wastes, EPA-600/4-79-020, U.S. Environmental Protection Agency, Environmental Monitoring and Support Laboratory, Cincinnati, Ohio 45268, March 1979.
- Goerlitz, D.F., and Law, L.M. *Bulletin for Environmental Contamination and Toxicology*, 6, 9 (1971).
- "Manual of Analytical Methods for the Analysis of Pesticides in Human and Environmental Samples," EPA-600/8-80-038, U.S. Environmental Protection Agency, Health Effects Research Laboratory, Research Triangle Park, North Carolina.
- Burke, J.A. "Gas Chromatography for Pesticide Residue Analysis; Some Practical Aspects," *Journal of the Association of Official Analytical Chemists*, 48, 1037 (1965).
- Webb, R.G., and McCall, A.C. "Quantitative PCB Standards for Election Capture Gas Chromatography," *Journal of Chromatographic Science*, 11, 366 (1973).
- "Method Detection Limit and Analytical Curve Studies, EPA Methods 606, 607, and 608," Special letter report for EPA Contract 68-03-2606, U.S. Environmental Protection Agency, Environmental Monitoring and Support Laboratory, Cincinnati, Ohio 45268, June 1980.
- "EPA Method Study 18 Method 608—Organochlorine Pesticides and PCBs," EPA 600/4-84-061, National Technical Information Service, PB84-211358, Springfield, Virginia 22161, June 1984.

TABLE 1—CHROMATOGRAPHIC CONDITIONS AND METHOD DETECTION LIMITS

| Parameter | Retention time (min) | | Method detection limit (µg/L) |
|--------------------------|----------------------|--------|-------------------------------|
| | Col. 1 | Col. 2 | |
| α-BHC | 1.35 | 1.82 | 0.003 |
| γ-BHC | 1.70 | 2.13 | 0.004 |
| β-BHC | 1.90 | 1.97 | 0.006 |
| Heptachlor | 2.00 | 3.35 | 0.003 |
| δ-BHC | 2.15 | 2.20 | 0.009 |
| Aldrin | 2.40 | 4.10 | 0.004 |
| Heptachlor epoxide | 3.50 | 5.00 | 0.083 |
| Endosulfan I | 4.50 | 6.20 | 0.014 |
| 4,4'-DDE | 5.13 | 7.15 | 0.004 |
| Dieldrin | 5.45 | 7.23 | 0.002 |
| Endrin | 6.55 | 8.10 | 0.006 |

TABLE 1—CHROMATOGRAPHIC CONDITIONS AND METHOD DETECTION LIMITS—Continued

| Parameter | Retention time (min) | | Method detection limit (µg/L) |
|--------------------------|----------------------|--------|-------------------------------|
| | Col. 1 | Col. 2 | |
| 4,4'-DDD | 7.83 | 9.08 | 0.011 |
| Endosulfan II | 8.00 | 8.28 | 0.004 |
| 4,4'-DDT | 9.40 | 11.75 | 0.012 |
| Endrin aldehyde | 11.82 | 9.30 | 0.023 |
| Endosulfan sulfate | 14.22 | 10.70 | 0.066 |
| Chlordane | mr | mr | 0.014 |
| Toxaphene | mr | mr | 0.24 |
| PCB-1016 | mr | mr | nd |
| PCB-1221 | mr | mr | nd |
| PCB-1232 | mt | mr | nd |
| PCB-1242 | mr | mr | 0.065 |
| PCB-1248 | mr | mr | nd |
| PCB-1254 | mr | mr | nd |
| PCB-1260 | mr | mr | nd |

AColumn 1 conditions: Supelcoport (100/120 mesh) coated with 1.5% SP-2250/1.95% SP-2401 packed in a 1.8 m long x 4 mm ID glass column with 5% methane/95% argon carrier gas at 60 mL/min flow rate. Column temperature held isothermal at 200 °C, except for PCB-1016 through PCB-1248, should be measured at 160 °C.

AColumn 2 conditions: Supelcoport (100/120 mesh) coated with 3% OV-1 packed in a 1.8 m long x 4 mm ID glass column with 5% methane/95% argon carrier gas at 60 mL/min flow rate. Column temperature held isothermal at 200 °C for the pesticides; at 140 °C for PCB-1221 and 1232; and at 170 °C for PCB-1016 and 1242 to 1268.

Amr=Multiple peak response. See Figures 2 thru 10.
And=Not determined.

TABLE 2—DISTRIBUTION OF CHLORINATED PESTICIDES AND PCBs INTO FLORISIL COLUMN FRACTIONS 2

| Parameter | Percent recovery by fraction ^a | | |
|--------------------------|---|-----|-----|
| | 1 | 2 | 3 |
| Aldrin | 100 | | |
| α-BHC | 100 | | |
| β-BHC | 97 | | |
| δ-BHC | 98 | | |
| γ-BHC | 100 | | |
| Chlordane | 100 | | |
| 4,4'-DDD | 99 | | |
| 4,4'-DDE | 98 | | |
| 4,4'-DDT | 100 | | |
| Dieldrin | 0 | 100 | |
| Endosulfan I | 37 | 64 | |
| Endosulfan II | 0 | 7 | 91 |
| Endosulfan sulfate | 0 | 0 | 106 |
| Endrin | 4 | 96 | |
| Endrin aldehyde | 0 | 68 | 26 |
| Heptachlor | 100 | | |
| Heptachlor epoxide | 100 | | |
| Toxaphene | 96 | | |
| PCB-1016 | 97 | | |
| PCB-1221 | 97 | | |
| PCB-1232 | 95 | 4 | |
| PCB-1242 | 97 | | |
| PCB-1248 | 103 | | |
| PCB-1254 | 90 | | |
| PCB-1260 | 95 | | |

^aEluant composition:
Fraction 1—6% ethyl ether in hexane.
Fraction 2—15% ethyl ether in hexane.
Fraction 3—50% ethyl ether in hexane.

TABLE 3—QC ACCEPTANCE CRITERIA—METHOD 608

| Parameter | Test conc. (µg/L) | Limit for s (µg/L) | Range for X (µg/L) | Range for P, P _s (%) |
|--------------|-------------------|--------------------|--------------------|---------------------------------|
| Aldrin | 2.0 | 0.42 | 1.08-2.24 | 42-122 |
| α-BHC | 2.0 | 0.48 | 0.98-2.44 | 37-134 |
| β-BHC | 2.0 | 0.64 | 0.78-2.60 | 17-147 |
| δ-BHC | 2.0 | 0.72 | 1.01-2.37 | 19-140 |
| γ-BHC | 2.0 | 0.46 | 0.86-2.32 | 32-127 |

TABLE 3—QC ACCEPTANCE CRITERIA—METHOD 608—Continued

| Parameter | Test conc. (µg/L) | Limit for s (µg/L) | Range for X (µg/L) | Range for P, P _s (%) |
|--------------------|-------------------|--------------------|--------------------|---------------------------------|
| Chlordane | 50 | 10.0 | 27.6–54.3 | 45–119 |
| 4,4'-DDD | 10 | 2.8 | 4.8–12.6 | 31–141 |
| 4,4'-DDE | 2.0 | 0.55 | 1.08–2.60 | 30–145 |
| 4,4'-DDT | 10 | 3.6 | 4.6–13.7 | 25–160 |
| Dieldrin | 2.0 | 0.76 | 1.15–2.49 | 36–146 |
| Endosulfan I | 2.0 | 0.49 | 1.14–2.82 | 45–153 |
| Endosulfan II | 10 | 6.1 | 2.2–17.1 | D–202 |
| Endosulfan Sulfate | 10 | 2.7 | 3.8–13.2 | 26–144 |
| Endrin | 10 | 3.7 | 5.1–12.6 | 30–147 |
| Heptachlor | 2.0 | 0.40 | 0.86–2.00 | 34–111 |
| Heptachlor epoxide | 2.0 | 0.41 | 1.13–2.63 | 37–142 |
| Toxaphene | 50.0 | 12.7 | 27.8–55.6 | 41–126 |
| PCB-1016 | 50 | 10.0 | 30.5–51.5 | 50–114 |
| PCB-1221 | 50 | 24.4 | 22.1–75.2 | 15–178 |
| PCB-1232 | 50 | 17.9 | 14.0–98.5 | 10–215 |
| PCB-1242 | 50 | 12.2 | 24.8–69.6 | 39–150 |
| PCB-1248 | 50 | 15.9 | 29.0–70.2 | 38–158 |
| PCB-1254 | 50 | 13.8 | 22.2–57.9 | 29–131 |
| PCB-1260 | 50 | 10.4 | 18.7–54.9 | 8–127 |

s=Standard deviation of four recovery measurements, in µg/L (Section 8.2.4).
 X=Average recovery for four recovery measurements, in µg/L (Section 8.2.4).
 P, P_s=Percent recovery measured (Section 8.3.2, Section 8.4.2).
 D=Detected; result must be greater than zero.

NOTE: These criteria are based directly upon the method performance data in Table 4. Where necessary, the limits for recovery have been broadened to assure applicability of the limits to concentrations below those used to develop Table 4.

TABLE 4—METHOD ACCURACY AND PRECISION AS FUNCTIONS OF CONCENTRATION—METHOD 608

| Parameter | Accuracy, as recovery, X' (µg/L) | Single analyst precision, s' (µg/L) | Overall precision, S' (µg/L) |
|--------------------|----------------------------------|-------------------------------------|------------------------------|
| Aldrin | 0.81C+0.04 | 0.16X̄-0.04 | 0.20X̄-0.01 |
| α-BHC | 0.84C+0.03 | 0.13X̄+0.04 | 0.23X̄-0.00 |
| β-BHC | 0.81C+0.07 | 0.22X̄-0.02 | 0.33X̄-0.05 |
| δ-BHC | 0.81C+0.07 | 0.18X̄+0.09 | 0.25X̄+0.03 |
| γ-BHC | 0.82C-0.05 | 0.12X̄+0.06 | 0.22X̄+0.04 |
| Chlordane | 0.82C-0.04 | 0.13X̄+0.13 | 0.18X̄+0.18 |
| 4,4'-DDD | 0.84C+0.30 | 0.20X̄-0.18 | 0.27X̄-0.14 |
| 4,4'-DDE | 0.85C+0.14 | 0.13X̄+0.06 | 0.28X̄-0.09 |
| 4,4'-DDT | 0.93C-0.13 | 0.17X̄+0.39 | 0.31X̄-0.21 |
| Dieldrin | 0.90C+0.02 | 0.12X̄+0.19 | 0.16X̄+0.16 |
| Endosulfan I | 0.97C+0.04 | 0.10X̄+0.07 | 0.18X̄+0.08 |
| Endosulfan II | 0.93C+0.34 | 0.41X̄-0.65 | 0.47X̄-0.20 |
| Endosulfan Sulfate | 0.89C-0.37 | 0.13X̄+0.33 | 0.24X̄+0.35 |
| Endrin | 0.89C-0.04 | 0.20X̄+0.25 | 0.24X̄+0.25 |
| Heptachlor | 0.69C+0.04 | 0.06X̄+0.13 | 0.16X̄+0.08 |
| Heptachlor epoxide | 0.89C+0.10 | 0.18X̄-0.11 | 0.25X̄-0.08 |
| Toxaphene | 0.80C+1.74 | 0.09X̄+3.20 | 0.20X̄+0.22 |
| PCB-1016 | 0.81C+0.50 | 0.13X̄+0.15 | 0.15X̄+0.45 |
| PCB-1221 | 0.96C+0.65 | 0.29X̄-0.76 | 0.35X̄-0.62 |
| PCB-1232 | 0.91C+10.79 | 0.21X̄-1.93 | 0.31X̄+3.50 |
| PCB-1242 | 0.93C+0.70 | 0.11X̄+1.40 | 0.21X̄+1.52 |
| PCB-1248 | 0.97C+1.06 | 0.17X̄+0.41 | 0.25X̄-0.37 |
| PCB-1254 | 0.76C+2.07 | 0.15X̄+1.66 | 0.17X̄+3.62 |
| PCB-1260 | 0.66C+3.76 | 0.22X̄-2.37 | 0.39X̄-4.86 |

X'=Expected recovery for one or more measurements of a sample containing a concentration of C, in µg/L.
 s'=Expected single analyst standard deviation of measurements at an average concentration found of X̄, in µg/L.
 S'=Expected interlaboratory standard deviation of measurements at an average concentration found of X̄, in µg/L.
 C=True value for the concentration, in µg/L.
 X=Average recovery found for measurements of samples containing a concentration of C, in µg/L.

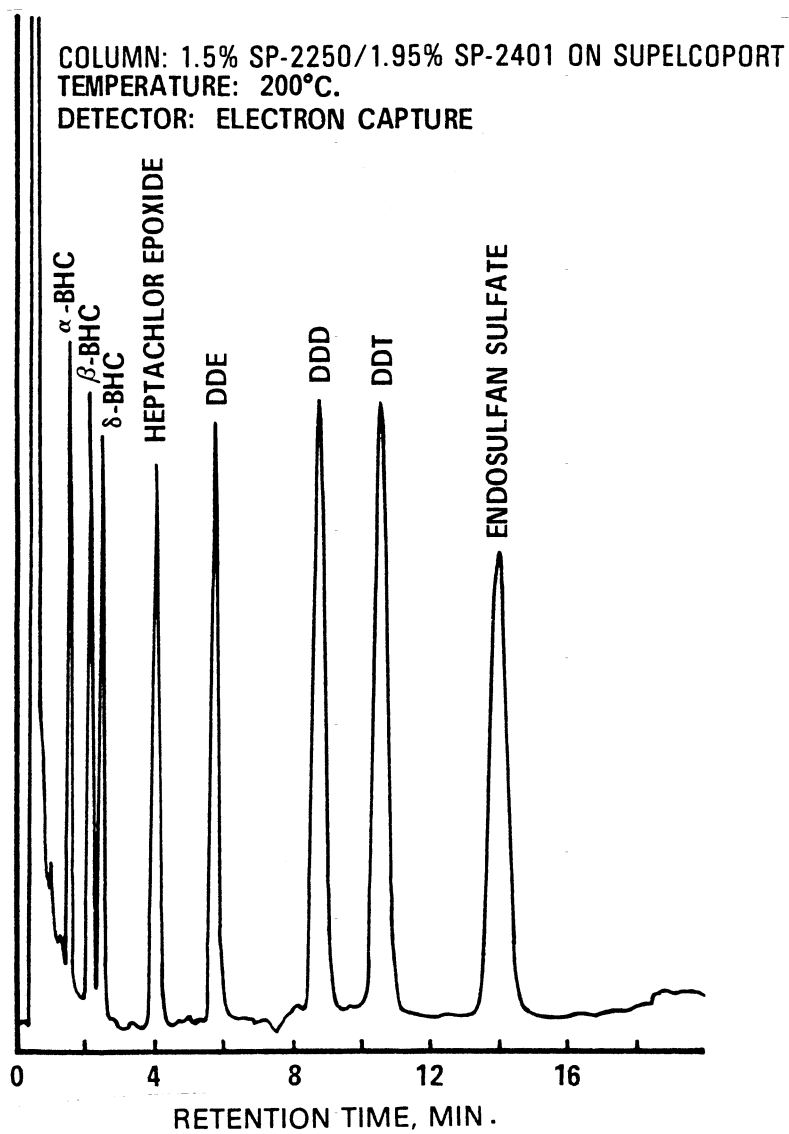

Figure 1. Gas chromatogram of pesticides.

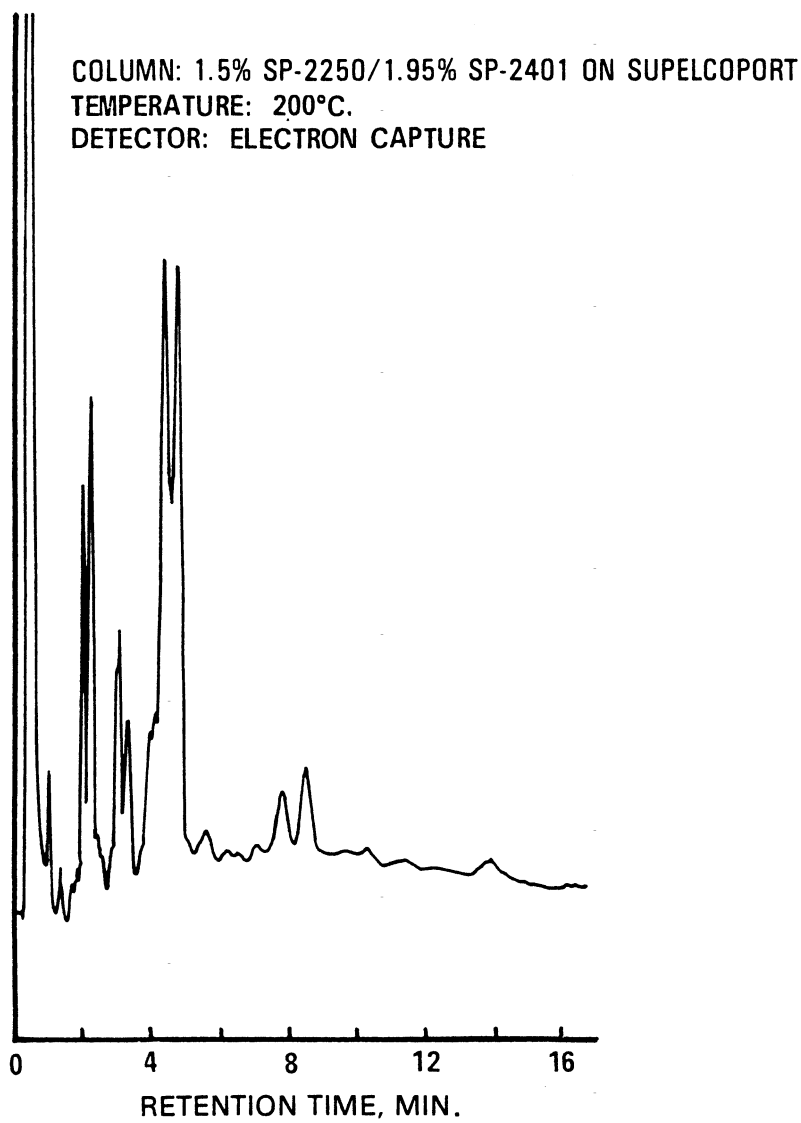

Figure 2. Gas chromatogram of chlordane.

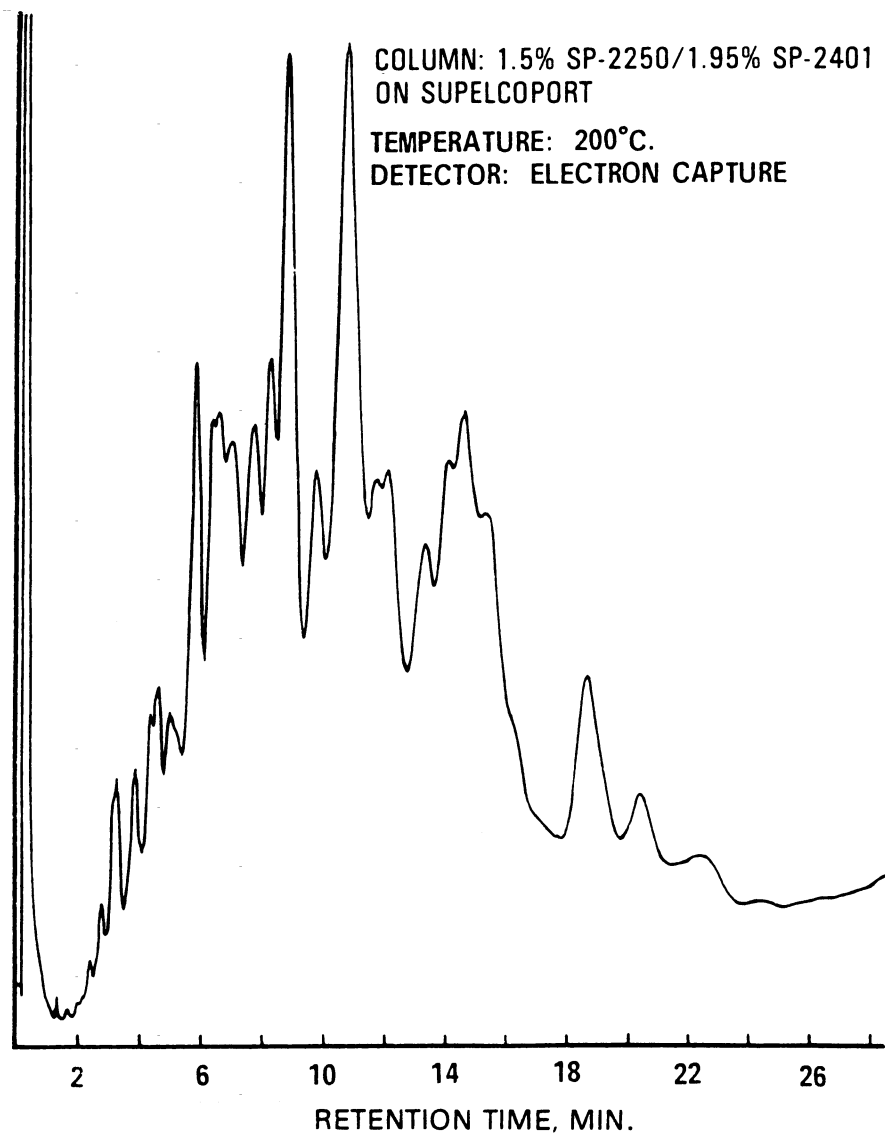

Figure 3. Gas chromatogram of toxaphene.

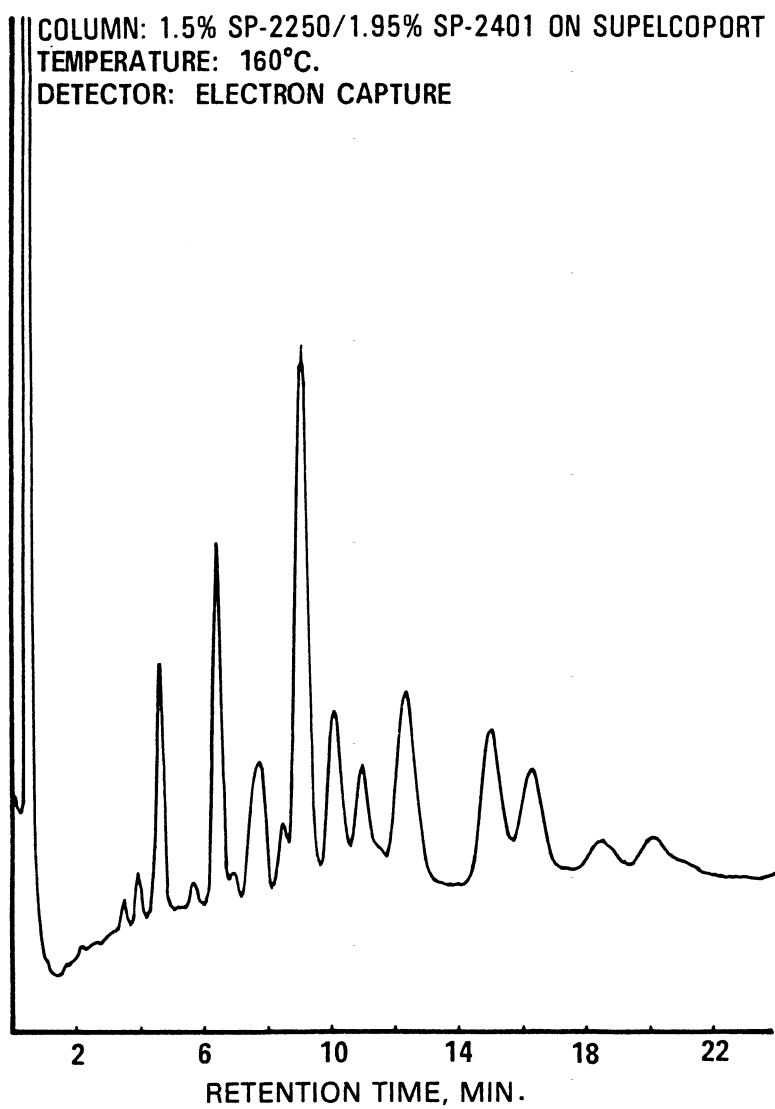

Figure 4. Gas chromatogram of PCB-1016.

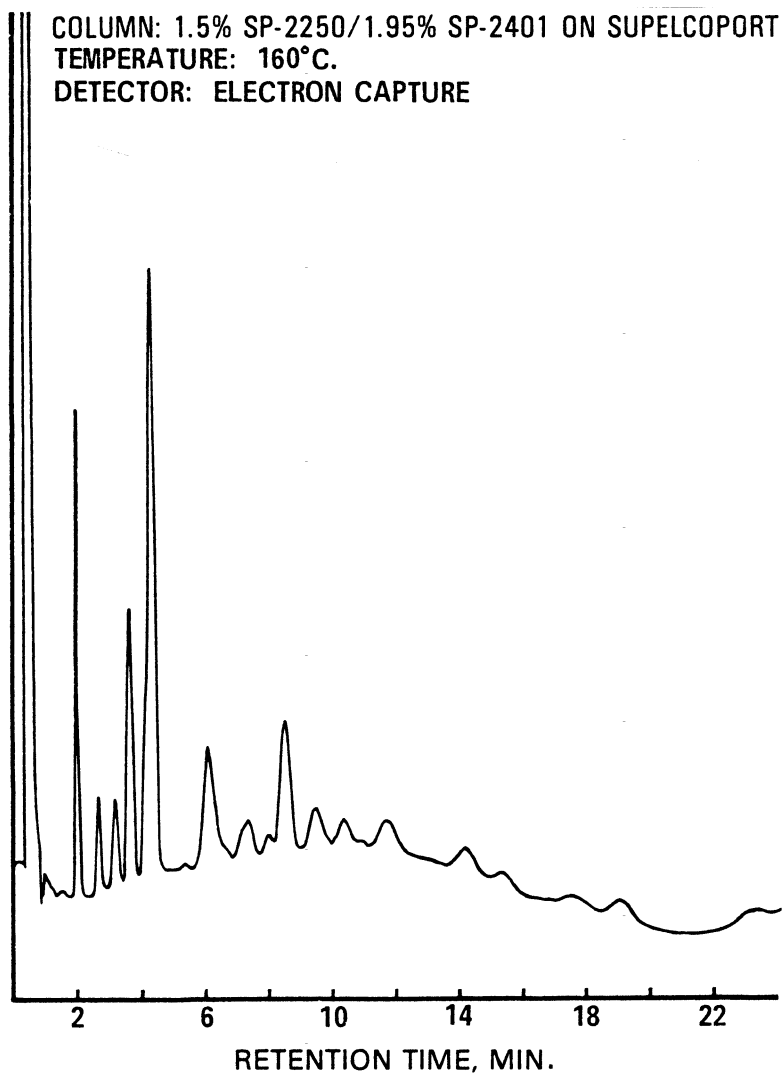

Figure 5. Gas chromatogram of PCB-1221.

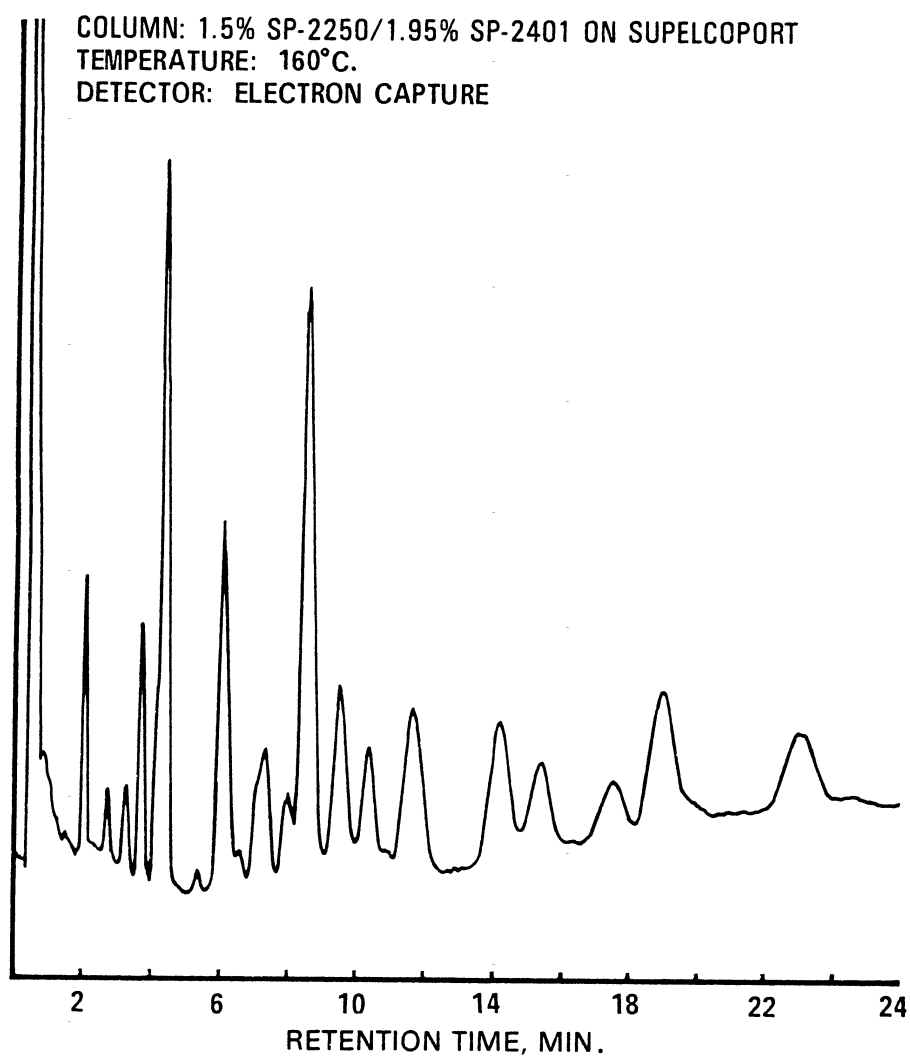

Figure 6. Gas chromatogram of PCB-1232.

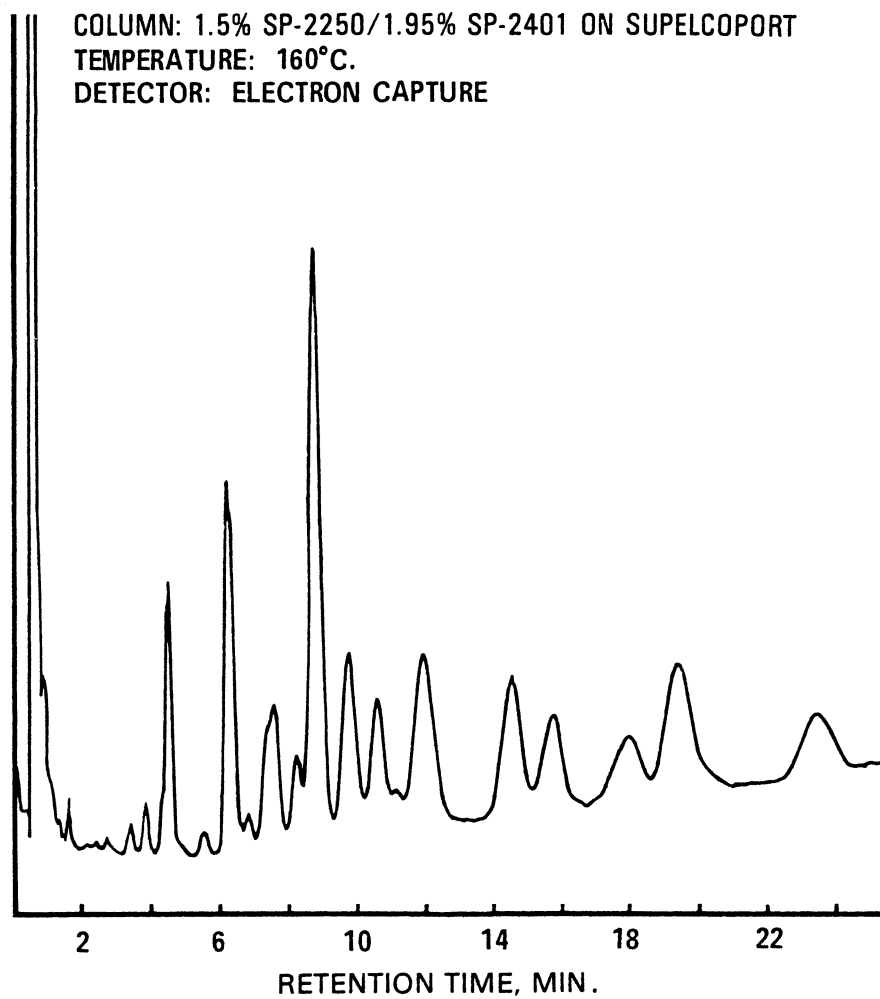

Figure 7. Gas chromatogram of PCB-1242.

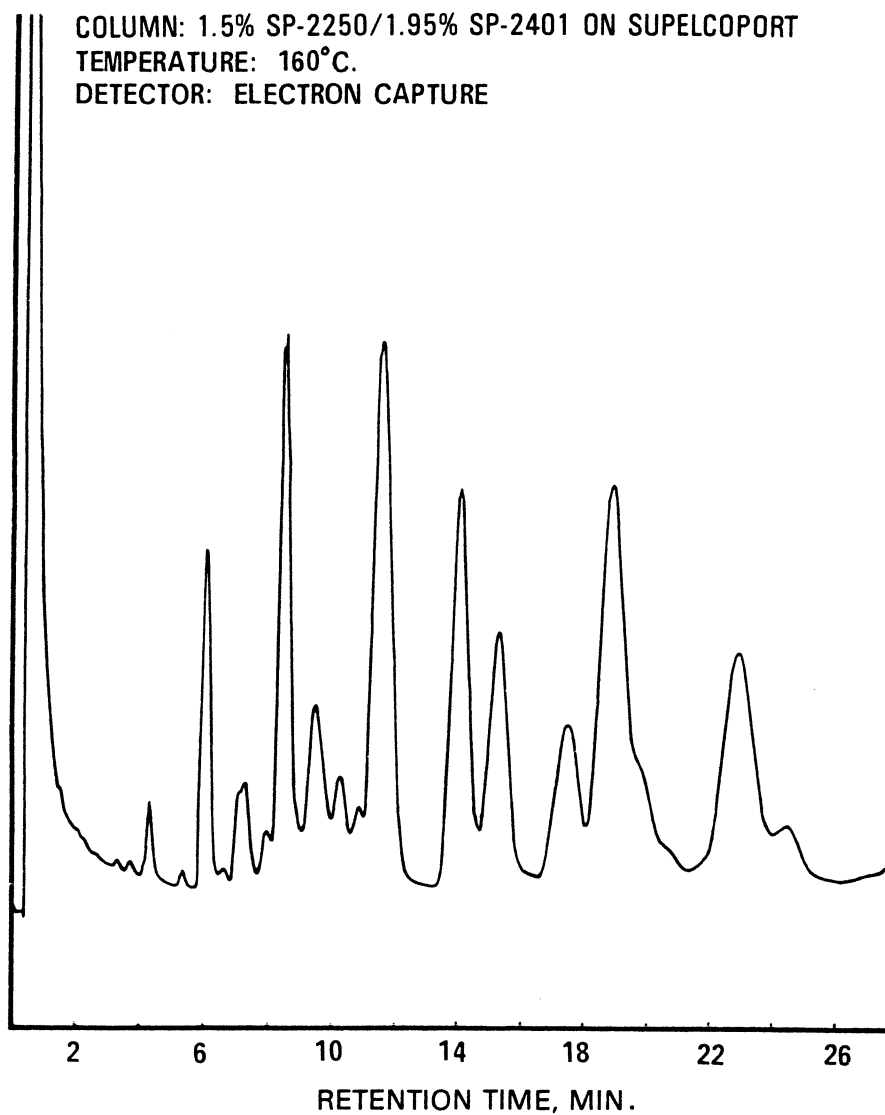

Figure 8. Gas chromatogram of PCB-1248.

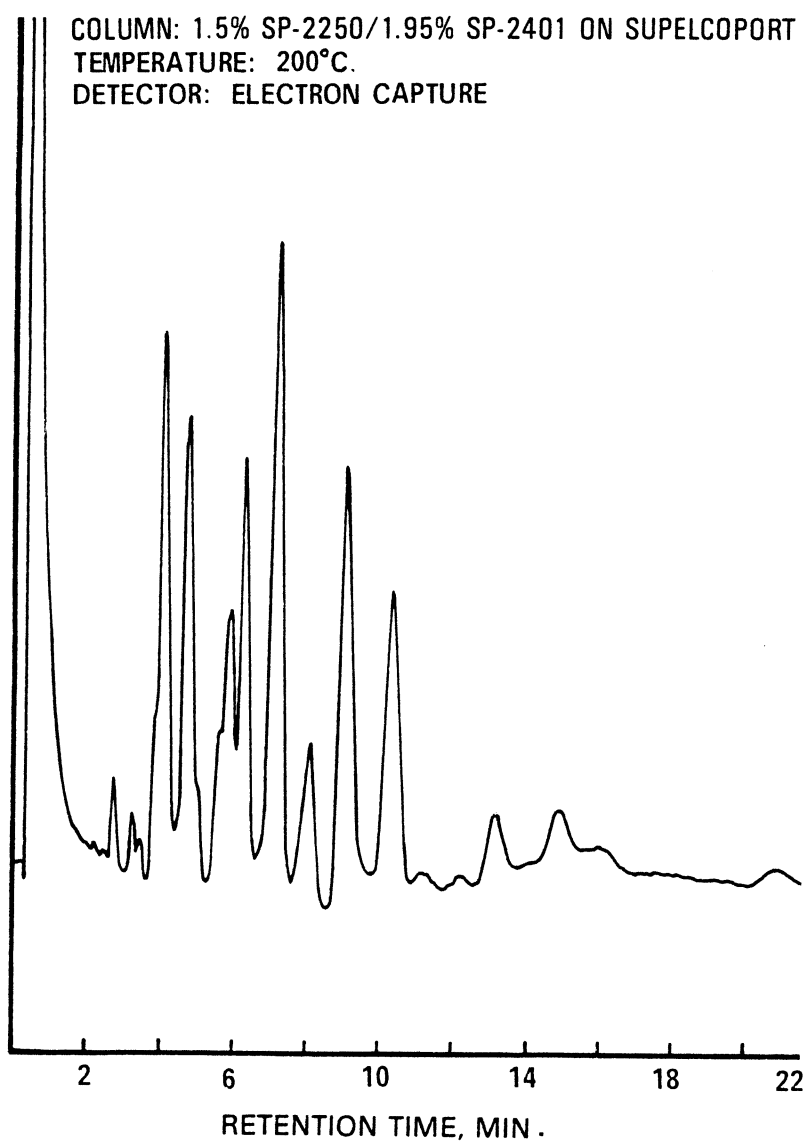

Figure 9. Gas chromatogram of PCB-1254.

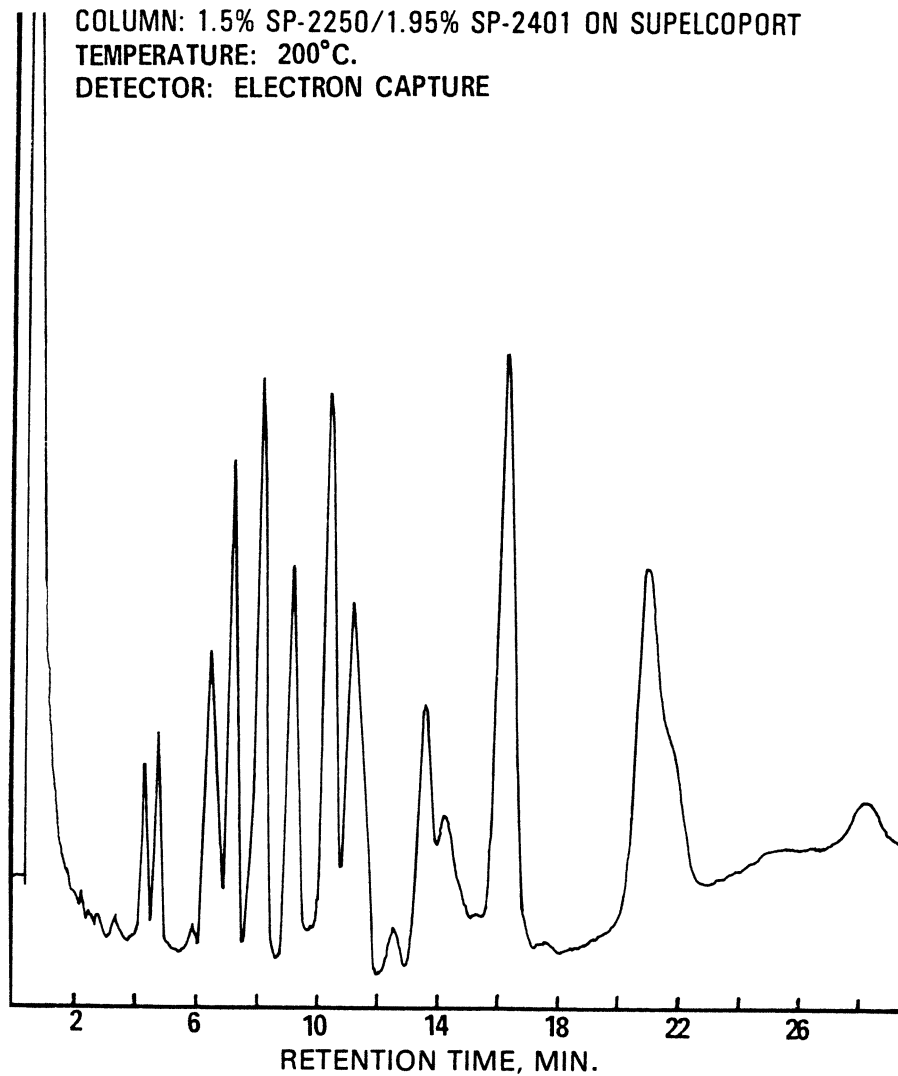

Figure 10. Gas chromatogram of PCB-1260.

METHOD 609—NITROAROMATICS AND ISOPHORONE

1. Scope and Application

1.1 This method covers the determination of certain nitroaromatics and isophorone. The following parameters may be determined by this method:

| Parameter | STORET No. | CAS No. |
|--------------------------|------------|----------|
| 2,4-Dinitrotoluene | 34611 | 121-14-2 |
| 2,6-Dinitrotoluene | 34626 | 606-20-2 |
| Isophorone | 34408 | 78-59-1 |
| Nitrobenzene | 34447 | 98-95-3 |

1.2 This is a gas chromatographic (GC) method applicable to the determination of

the compounds listed above in municipal and industrial discharges as provided under 40 CFR 136.1. When this method is used to analyze unfamiliar samples for any or all of the compounds above, compound identifications should be supported by at least one additional qualitative technique. This method describes analytical conditions for a second gas chromatographic column that can be used to confirm measurements made with the primary column. Method 625 provides gas chromatograph/mass spectrometer (GC/MS) conditions appropriate for the qualitative and quantitative confirmation of results for all of the parameters listed above, using the extract produced by this method.

1.3 The method detection limit (MDL, defined in Section 14.1)¹ for each parameter is listed in Table 1. The MDL for a specific wastewater may differ from those listed, depending upon the nature of interferences in the sample matrix.

1.4 The sample extraction and concentration steps in this method are essentially the same as in Methods 606, 608, 611, and 612. Thus, a single sample may be extracted to measure the parameters included in the scope of each of these methods. When cleanup is required, the concentration levels must be high enough to permit selecting aliquots, as necessary, to apply appropriate cleanup procedures. The analyst is allowed the latitude, under Section 12, to select chromatographic conditions appropriate for the simultaneous measurement of combinations of these parameters.

1.5 Any modification of this method, beyond those expressly permitted, shall be considered as a major modification subject to application and approval of alternate test procedures under 40 CFR 136.4 and 136.5.

1.6 This method is restricted to use by or under the supervision of analysts experienced in the use of a gas chromatograph and in the interpretation of gas chromatograms. Each analyst must demonstrate the ability to generate acceptable results with this method using the procedure described in Section 8.2.

2. Summary of Method

2.1 A measured volume of sample, approximately 1-L, is extracted with methylene chloride using a separatory funnel. The methylene chloride extract is dried and exchanged to hexane during concentration to a volume of 10 mL or less. Isophorone and nitrobenzene are measured by flame ionization detector gas chromatography (FIDGC). The dinitrotoluenes are measured by electron capture detector gas chromatography (ECDGC).²

2.2 The method provides a Florisil column cleanup procedure to aid in the elimination of interferences that may be encountered.

3. Interferences

3.1 Method interferences may be caused by contaminants in solvents, reagents, glassware, and other sample processing hardware that lead to discrete artifacts and/or elevated baselines in gas chromatograms. All of these materials must be routinely demonstrated to be free from interferences under the conditions of the analysis by running laboratory reagent blanks as described in Section 8.1.3.

3.1.1 Glassware must be scrupulously cleaned.³ Clean all glassware as soon as possible after use by rinsing with the last solvent used in it. Solvent rinsing should be followed by detergent washing with hot water, and rinses with tap water and distilled water. The glassware should then be drained dry, and heated in a muffle furnace at 400 °C for 15 to 30 min. Some thermally stable materials, such as PCBs, may not be eliminated by this treatment. Solvent rinses with acetone and pesticide quality hexane may be substituted for the muffle furnace heating. Thorough rinsing with such solvents usually eliminates PCB interference. Volumetric ware should not be heated in a muffle furnace. After drying and cooling, glassware should be sealed and stored in a clean environment to prevent any accumulation of dust or other contaminants. Store inverted or capped with aluminum foil.

3.1.2 The use of high purity reagents and solvents helps to minimize interference problems. Purification of solvents by distillation in all-glass systems may be required.

3.2 Matrix interferences may be caused by contaminants that are co-extracted from the sample. The extent of matrix interferences will vary considerably from source to source, depending upon the nature and diversity of the industrial complex or municipality being sampled. The cleanup procedure in Section 11 can be used to overcome many of these interferences, but unique samples may require additional cleanup approaches to achieve the MDL listed in Table 1.

4. Safety

4.1 The toxicity or carcinogenicity of each reagent used in this method has not been precisely defined; however, each chemical compound should be treated as a potential health hazard. From this viewpoint, exposure to these chemicals must be reduced to the lowest possible level by whatever means available. The laboratory is responsible for maintaining a current awareness file of OSHA regulations regarding the safe handling of the chemicals specified in this method. A reference file of material data handling sheets should also be made available to all personnel involved in the chemical analysis. Additional references to laboratory safety are available and have been identified⁴⁻⁶ for the information of the analyst.

5. Apparatus and Materials

5.1 Sampling equipment, for discrete or composite sampling.

5.1.1 Grab sample bottle—1-L or 1-qt, amber glass, fitted with a screw cap lined with Teflon. Foil may be substituted for Teflon if the sample is not corrosive. If amber bottles are not available, protect samples from light. The bottle and cap liner must be washed, rinsed with acetone or methylene chloride, and dried before use to minimize contamination.

5.1.2 Automatic sampler (optional)—The sampler must incorporate glass sample containers for the collection of a minimum of 250 mL of sample. Sample containers must be kept refrigerated at 4°C and protected from light during compositing. If the sampler uses a peristaltic pump, a minimum length of compressible silicone rubber tubing may be used. Before use, however, the compressible tubing should be thoroughly rinsed with methanol, followed by repeated rinsings with distilled water to minimize the potential for contamination of the sample. An integrating flow meter is required to collect flow proportional composites.

5.2 Glassware (All specifications are suggested. Catalog numbers are included for illustration only.):

5.2.1 Separatory funnel—2-L, with Teflon stopcock.

5.2.2 Drying column—Chromatographic column, approximately 400 mm long × 19 mm ID, with coarse frit filter disc.

5.2.3 Chromatographic column—100 mm long × 10 mm ID, with Teflon stopcock.

5.2.4 Concentrator tube, Kuderna-Danish—10-mL, graduated (Kontes K-570050-1025 or equivalent). Calibration must be checked at the volumes employed in the test. Ground glass stopper is used to prevent evaporation of extracts.

5.2.5 Evaporative flask, Kuderna-Danish—500-mL (Kontes K-570001-0500 or equivalent). Attach to concentrator tube with springs.

5.2.6 Snyder column, Kuderna-Danish—Three-ball macro (Kontes K-503000-0121 or equivalent).

5.2.7 Snyder column, Kuderna-Danish—Two-ball micro (Kontes K-569001-0219 or equivalent).

5.2.8 Vials—10 to 15-mL, amber glass, with Teflon-lined screw cap.

5.3 Boiling chips—Approximately 10/40 mesh. Heat to 400°C for 30 min or Soxhlet extract with methylene chloride.

5.4 Water bath—Heated, with concentric ring cover, capable of temperature control ($\pm 2^\circ\text{C}$). The bath should be used in a hood.

5.5 Balance—Analytical, capable of accurately weighing 0.0001 g.

5.6 Gas chromatograph—An analytical system complete with gas chromatograph suitable for on-column injection and all required accessories including syringes, ana-

lytical columns, gases, detector, and strip-chart recorder. A data system is recommended for measuring peak areas.

5.6.1 Column 1—1.2 m long × 2 or 4 mm ID glass, packed with 1.95% QF-1/1.5% OV-17 on Gas-Chrom Q (80/100 mesh) or equivalent. This column was used to develop the method performance statements given in Section 14. Guidelines for the use of alternate column packings are provided in Section 12.1.

5.6.2 Column 2—3.0 m long × 2 or 4 mm ID glass, packed with 3% OV-101 on Gas-Chrom Q (80/100 mesh) or equivalent.

5.6.3 Detectors—Flame ionization and electron capture detectors. The flame ionization detector (FID) is used when determining isophorone and nitrobenzene. The electron capture detector (ECD) is used when determining the dinitrotoluenes. Both detectors have proven effective in the analysis of wastewaters and were used in develop the method performance statements in Section 14. Guidelines for the use to alternate detectors are provided in Section 12.1.

6. Reagents

6.1 Reagent water—Reagent water is defined as a water in which an interferent is not observed at the MDL of the parameters of interest.

6.2 Sodium hydroxide solution (10 N)—Dissolve 40 g of NaOH (ACS) in reagent water and dilute to 100 mL.

6.3 Sulfuric acid (1+1)—Slowly, add 50 mL of H₂SO₄ (ACS, sp. gr. 1.84) to 50 mL of reagent water.

6.4 Acetone, hexane, methanol, methylene chloride—Pesticide quality or equivalent.

6.5 Sodium sulfate—(ACS) Granular, anhydrous. Purify by heating at 400 °C for 4 h in a shallow tray.

6.6 Florisil—PR grade (60/100 mesh). Purchase activated at 1250 °F and store in dark in glass containers with ground glass stoppers or foil-lined screw caps. Before use, activate each batch at least 16 h at 200 °C in a foil-covered glass container and allow to cool.

6.7 Stock standard solutions (1.00 µg/µL)—Stock standard solutions can be prepared from pure standard materials or purchased as certified solutions.

6.7.1 Prepare stock standard solutions by accurately weighing about 0.0100 g of pure material. Dissolve the material in hexane and dilute to volume in a 10-mL volumetric flask. Larger volumes can be used at the convenience of the analyst. When compound purity is assayed to be 96% or greater, the weight can be used without correction to calculate the concentration of the stock standard. Commercially prepared stock standards can be used at any concentration if they are certified by the manufacturer or by an independent source.

6.7.2 Transfer the stock standard solutions into Teflon-sealed screw-cap bottles.

Store at 4 °C and protect from light. Stock standard solutions should be checked frequently for signs of degradation or evaporation, especially just prior to preparing calibration standards from them.

6.7.3 Stock standard solutions must be replaced after six months, or sooner if comparison with check standards indicates a problem.

6.8 Quality control check sample concentrate—See Section 8.2.1.

7. Calibration

7.1 Establish gas chromatographic operating conditions equivalent to those given in Table 1. The gas chromatographic system can be calibrated using the external standard technique (Section 7.2) or the internal standard technique (Section 7.3).

7.2 External standard calibration procedure:

7.2.1 Prepare calibration standards at a minimum of three concentration levels for each parameter of interest by adding volumes of one or more stock standards to a volumetric flask and diluting to volume with hexane. One of the external standards should be at a concentration near, but above, the MDL (Table 1) and the other concentrations should correspond to the expected range of concentrations found in real samples or should define the working range of the detector.

7.2.2 Using injections of 2 to 5 µL, analyze each calibration standard according to Section 12 and tabulate peak height or area responses against the mass injected. The results can be used to prepare a calibration curve for each compound. Alternatively, if the ratio of response to amount injected (calibration factor) is a constant over the working range (<10% relative standard deviation, RSD) linearity through the origin can be assumed and the average ratio or calibration factor can be used in place of a calibration curve.

7.3 Internal standard calibration procedure—To use this approach, the analyst must select one or more internal standards that are similar in analytical behavior to the compounds of interest. The analyst must further demonstrate that the measurement of the internal standard is not affected by method or matrix interferences. Because of these limitations, no internal standard can be suggested that is applicable to all samples.

7.3.1 Prepare calibration standards at a minimum of three concentration levels for each parameter of interest by adding volumes of one or more stock standards to a volumetric flask. To each calibration standard, add a known constant amount of one or more internal standards, and dilute to volume with hexane. One of the standards should be at a concentration near, but above, the MDL and the other concentrations

should correspond to the expected range of concentrations found in real samples or should define the working range of the detector.

7.3.2 Using injections of 2 to 5 µL, analyze each calibration standard according to Section 12 and tabulate peak height or area responses against concentration for each compound and internal standard. Calculate response factors (RF) for each compound using Equation 1.

Equation 1.

$$RF = \frac{(A_s)(C_{is})}{(A_{is})(C_s)}$$

where:

A_s=Response for the parameter to be measured.

A_{is}=Response for the internal standard.

C_{is}=Concentration of the internal standard (µg/L).

C_s=Concentration of the parameter to be measured (µg/L).

If the RF value over the working range is a constant (<10% RSD), the RF can be assumed to be invariant and the average RF can be used for calculations. Alternatively, the results can be used to plot a calibration curve of response ratios, A_s/A_{is}, vs. RF.

7.4 The working calibration curve, calibration factor, or RF must be verified on each working day by the measurement of one or more calibration standards. If the response for any parameter varies from the predicted response by more than ±15%, a new calibration curve must be prepared for that compound.

7.5 Before using any cleanup procedure, the analyst must process a series of calibration standards through the procedure to validate elution patterns and the absence of interferences from the reagents.

8. Quality Control

8.1 Each laboratory that uses this method is required to operate a formal quality control program. The minimum requirements of this program consist of an initial demonstration of laboratory capability and an ongoing analysis of spiked samples to evaluate and document data quality. The laboratory must maintain records to document the quality of data that is generated. Ongoing data quality checks are compared with established performance criteria to determine if the results of analyses meet the performance characteristics of the method. When results of sample spikes indicate atypical method performance, a quality control check standard must be analyzed to confirm that the measurements were performed in an in-control mode of operation.

8.1.1 The analyst must make an initial, one-time, demonstration of the ability to

generate acceptable accuracy and precision with this method. This ability is established as described in Section 8.2.

8.1.2 In recognition of advances that are occurring in chromatography, the analyst is permitted certain options (detailed in Sections 10.4, 11.1, and 12.1) to improve the separations or lower the cost of measurements. Each time such a modification is made to the method, the analyst is required to repeat the procedure in Section 8.2.

8.1.3 Before processing any samples, the analyst must analyze a reagent water blank to demonstrate that interferences from the analytical system and glassware are under control. Each time a set of samples is extracted or reagents are changed, a reagent water blank must be processed as a safeguard against laboratory contamination.

8.1.4 The laboratory must, on an ongoing basis, spike and analyze a minimum of 10% of all samples to monitor and evaluate laboratory data quality. This procedure is described in Section 8.3.

8.1.5 The laboratory must, on an ongoing basis, demonstrate through the analyses of quality control check standards that the operation of the measurement system is in control. This procedure is described in Section 8.4. The frequency of the check standard analyses is equivalent to 10% of all samples analyzed but may be reduced if spike recoveries from samples (Section 8.3) meet all specified quality control criteria.

8.1.6 The laboratory must maintain performance records to document the quality of data that is generated. This procedure is described in Section 8.5.

8.2 To establish the ability to generate acceptable accuracy and precision, the analyst must perform the following operations.

8.2.1 A quality control (QC) check sample concentrate is required containing each parameter of interest in acetone at a concentration of 20 µg/mL for each dinitrotoluene and 100 µg/mL for isophorone and nitrobenzene. The QC check sample concentrate must be obtained from the U.S. Environmental Protection Agency, Environmental Monitoring and Support Laboratory in Cincinnati, Ohio, if available. If not available from that source, the QC check sample concentrate must be obtained from another external source. If not available from either source above, the QC check sample concentrate must be prepared by the laboratory using stock standards prepared independently from those used for calibration.

8.2.2 Using a pipet, prepare QC check samples at the test concentrations shown in Table 2 by adding 1.00 mL of QC check sample concentrate to each of four 1-L aliquots of reagent water.

8.2.3 Analyze the well-mixed QC check samples according to the method beginning in Section 10.

8.2.4 Calculate the average recovery (\bar{X}) in µg/L, and the standard deviation of the recovery (s) in µg/L, for each parameter using the four results.

8.2.5 For each parameter compare s and \bar{X} with the corresponding acceptance criteria for precision and accuracy, respectively, found in Table 2. If s and \bar{X} for all parameters of interest meet the acceptance criteria, the system performance is acceptable and analysis of actual samples can begin. If any individual s exceeds the precision limit or any individual \bar{X} falls outside the range for accuracy, the system performance is unacceptable for that parameter. Locate and correct the source of the problem and repeat the test for all parameters of interest beginning with Section 8.2.2.

8.3 The laboratory must, on an ongoing basis, spike at least 10% of the samples from each sample site being monitored to assess accuracy. For laboratories analyzing one to ten samples per month, at least one spiked sample per month is required.

8.3.1 The concentration of the spike in the sample should be determined as follows:

8.3.1.1 If, as in compliance monitoring, the concentration of a specific parameter in the sample is being checked against a regulatory concentration limit, the spike should be at that limit or 1 to 5 times higher than the background concentration determined in Section 8.3.2, whichever concentration would be larger.

8.3.1.2 If the concentration of a specific parameter in the sample is not being checked against a limit specific to that parameter, the spike should be at the test concentration in Section 8.2.2 or 1 to 5 times higher than the background concentration determined in Section 8.3.2, whichever concentration would be larger.

8.3.1.3 If it is impractical to determine background levels before spiking (e.g., maximum holding times will be exceeded), the spike concentration should be (1) the regulatory concentration limit, if any; or, if none (2) the larger of either 5 times higher than the expected background concentration or the test concentration in Section 8.2.2.

8.3.2 Analyze one sample aliquot to determine the background concentration (B) of each parameter. If necessary, prepare a new QC check sample concentrate (Section 8.2.1) appropriate for the background concentrations in the sample. Spike a second sample aliquot with 1.0 mL of the QC check sample concentrate and analyze it to determine the concentration after spiking (A) of each parameter. Calculate each percent recovery (P) as $100(A - B)/T$, where T is the known true value of the spike.

8.3.3 Compare the percent recovery (P) for each parameter with the corresponding QC acceptance criteria found in Table 2. These acceptance criteria were calculated to include an allowance for error in measurement

of both the background and spike concentrations, assuming a spike to background ratio of 5:1. This error will be accounted for to the extent that the analyst's spike to background ratio approaches 5:1.⁷ If spiking was performed at a concentration lower than the test concentration in Section 8.2.2, the analyst must use either the QC acceptance criteria in Table 2, or optional QC acceptance criteria calculated for the specific spike concentration. To calculate optional acceptance criteria for the recovery of a parameter: (1) Calculate accuracy (X') using the equation in Table 3, substituting the spike concentration (T) for C; (2) calculate overall precision (S') using the equation in Table 3, substituting X' for X8; (3) calculate the range for recovery at the spike concentration as $(100 X'/T) \pm 2.44 (100 S'/T)\%$.⁷

8.3.4 If any individual P falls outside the designated range for recovery, that parameter has failed the acceptance criteria. A check standard containing each parameter that failed the criteria must be analyzed as described in Section 8.4.

8.4. If any parameter fails the acceptance criteria for recovery in Section 8.3, a QC check standard containing each parameter that failed must be prepared and analyzed.

NOTE: The frequency for the required analysis of a QC check standard will depend upon the number of parameters being simultaneously tested, the complexity of the sample matrix, and the performance of the laboratory.

8.4.1 Prepare the QC check standard by adding 1.0 mL of QC check concentrate (Section 8.2.1 or 8.3.2) to 1 L of reagent water. The QC check standard needs only to contain the parameters that failed criteria in the test in Section 8.3.

8.4.2 Analyze the QC check standard to determine the concentration measured (A) of each parameter. Calculate each percent recovery (P_s) as $100 (A/T)\%$, where T is the true value of the standard concentration.

8.4.3 Compare the percent recovery (P_s) for each parameter with the corresponding QC acceptance criteria found in Table 2. Only parameters that failed the test in Section 8.3 need to be compared with these criteria. If the recovery of any such parameter falls outside the designated range, the laboratory performance for that parameter is judged to be out of control, and the problem must be immediately identified and corrected. The analytical result for that parameter in the unspiked sample is suspect and may not be reported for regulatory compliance purposes.

8.5 As part of QC program for the laboratory, method accuracy for wastewater samples must be assessed and records must be maintained. After the analysis of five spiked wastewater samples as in Section 8.3, calculate the average percent recovery (P̄) and the standard deviation of the percent recovery (s_p). Express the accuracy assessment as

a percent recovery interval from $\bar{P} - 2s_p$ to $\bar{P} + 2s_p$. If $\bar{P} = 90\%$ and $s_p = 10\%$, for example, the accuracy interval is expressed as 70-110%. Update the accuracy assessment for each parameter on a regular basis (e.g. after each five to ten new accuracy measurements).

8.6 It is recommended that the laboratory adopt additional quality assurance practices for use with this method. The specific practices that are most productive depend upon the needs of the laboratory and the nature of the samples. Field duplicates may be analyzed to assess the precision of the environmental measurements. When doubt exists over the identification of a peak on the chromatogram, confirmatory techniques such as gas chromatography with a dissimilar column, specific element detector, or mass spectrometer must be used. Whenever possible, the laboratory should analyze standard reference materials and participate in relevant performance evaluation studies.

9. Sample Collection, Preservation, and Handling

9.1 Grab samples must be collected in glass containers. Conventional sampling practices⁸ should be followed, except that the bottle must not be prerinsed with sample before collection. Composite samples should be collected in refrigerated glass containers in accordance with the requirements of the program. Automatic sampling equipment must be as free as possible of Tygon tubing and other potential sources of contamination.

9.2 All samples must be iced or refrigerated at 4 °C from the time of collection until extraction.

9.3 All samples must be extracted within 7 days of collection and completely analyzed within 40 days of extraction.²

10. Sample Extraction

10.1 Mark the water meniscus on the side of the sample bottle for later determination of sample volume. Pour the entire sample into a 2-L separatory funnel. Check the pH of the sample with wide-range pH paper and adjust to within the range of 5 to 9 with sodium hydroxide solution or sulfuric acid.

10.2 Add 60 mL of methylene chloride to the sample bottle, seal, and shake 30 s to rinse the inner surface. Transfer the solvent to the separatory funnel and extract the sample by shaking the funnel for 2 min. with periodic venting to release excess pressure. Allow the organic layer to separate from the water phase for a minimum of 10 min. If the emulsion interface between layers is more than one-third the volume of the solvent layer, the analyst must employ mechanical techniques to complete the phase separation. The optimum technique depends upon the sample, but may include stirring, filtration

of the emulsion through glass wool, centrifugation, or other physical methods. Collect the methylene chloride extract in a 250-mL Erlenmeyer flask.

10.3 Add a second 60-mL volume of methylene chloride to the sample bottle and repeat the extraction procedure a second time, combining the extracts in the Erlenmeyer flask. Perform a third extraction in the same manner.

10.4 Assemble a Kuderna-Danish (K-D) concentrator by attaching a 10-mL concentrator tube to a 500-mL evaporative flask. Other concentration devices or techniques may be used in place of the K-D concentrator if the requirements of Section 8.2 are met.

10.5 Pour the combined extract through a solvent-rinsed drying column containing about 10 cm of anhydrous sodium sulfate, and collect the extract in the K-D concentrator. Rinse the Erlenmeyer flask and column with 20 to 30 mL of methylene chloride to complete the quantitative transfer.

10.6 Sections 10.7 and 10.8 describe a procedure for exchanging the methylene chloride solvent to hexane while concentrating the extract volume to 1.0 mL. When it is not necessary to achieve the MDL in Table 2, the solvent exchange may be made by the addition of 50 mL of hexane and concentration to 10 mL as described in Method 606, Sections 10.7 and 10.8.

10.7 Add one or two clean boiling chips to the evaporative flask and attach a three-ball Snyder column. Prewet the Snyder column by adding about 1 mL of methylene chloride to the top. Place the K-D apparatus on a hot water bath (60 to 65°C) so that the concentrator tube is partially immersed in the hot water, and the entire lower rounded surface of the flask is bathed with hot vapor. Adjust the vertical position of the apparatus and the water temperature as required to complete the concentration in 15 to 20 min. At the proper rate of distillation the balls of the column will actively chatter but the chambers will not flood with condensed solvent. When the apparent volume of liquid reaches 1 mL, remove the K-D apparatus and allow it to drain and cool for at least 10 min.

10.8 Remove the Snyder column and rinse the flask and its lower joint into the concentrator tube with 1 to 2 mL of methylene chloride. A 5-mL syringe is recommended for this operation. Add 1 to 2 mL of hexane and a clean boiling chip to the concentrator tube and attach a two-ball micro-Snyder column. Prewet the column by adding about 0.5 mL of hexane to the top. Place the micro-K-D apparatus on a hot water bath (60 to 65°C) so that the concentrator tube is partially immersed in the hot water. Adjust the vertical position of the apparatus and the water temperature as required to complete the concentration in 5 to 10 min. At the proper rate of distillation the balls of the column will actively chatter but the chambers will not flood. When the

apparent volume of liquid reaches 0.5 mL, remove the K-D apparatus and allow it to drain and cool for at least 10 min.

10.9 Remove the micro-Snyder column and rinse its lower joint into the concentrator tube with a minimum amount of hexane. Adjust the extract volume to 1.0 mL. Stopper the concentrator tube and store refrigerated if further processing will not be performed immediately. If the extract will be stored longer than two days, it should be transferred to a Teflon-sealed screw-cap vial. If the sample extract requires no further cleanup, proceed with gas chromatographic analysis (Section 12). If the sample requires further cleanup, proceed to Section 11.

10.10 Determine the original sample volume by refilling the sample bottle to the mark and transferring the liquid to a 1000-mL graduated cylinder. Record the sample volume to the nearest 5 mL.

11. Cleanup and Separation

11.1 Cleanup procedures may not be necessary for a relatively clean sample matrix. If particular circumstances demand the use of a cleanup procedure, the analyst may use the procedure below or any other appropriate procedure. However, the analyst first must demonstrate that the requirements of Section 8.2 can be met using the method as revised to incorporate the cleanup procedure.

11.2 Florisil column cleanup:

11.2.1 Prepare a slurry of 10 g of activated Florisil in methylene chloride/hexane (1+9)(V/V) and place the Florisil into a chromatographic column. Tap the column to settle the Florisil and add 1 cm of anhydrous sodium sulfate to the top. Adjust the elution rate to about 2 mL/min.

11.2.2 Just prior to exposure of the sodium sulfate layer to the air, quantitatively transfer the sample extract onto the column using an additional 2 mL of hexane to complete the transfer. Just prior to exposure of the sodium sulfate layer to the air, add 30 mL of methylene chloride/hexane (1 + 9)(V/V) and continue the elution of the column. Discard the eluate.

11.2.3 Next, elute the column with 30 mL of acetone/methylene chloride (1 + 9)(V/V) into a 500-mL K-D flask equipped with a 10-mL concentrator tube. Concentrate the collected fraction as in Sections 10.6, 10.7, 10.8, and 10.9 including the solvent exchange to 1 mL of hexane. This fraction should contain the nitroaromatics and isophorone. Analyze by gas chromatography (Section 12).

12. Gas Chromatography

12.1 Isophorone and nitrobenzene are analyzed by injection of a portion of the extract into an FIDGC. The dinitrotoluenes are analyzed by a separate injection into an ECDGC. Table 1 summarizes the recommended operating conditions for the gas chromatograph.

Included in this table are retention times and MDL that can be achieved under these conditions. Examples of the separations achieved by Column 1 are shown in Figures 1 and 2. Other packed or capillary (open-tubular) columns, chromatographic conditions, or detectors may be used if the requirements of Section 8.2 are met.

12.2 Calibrate the system daily as described in Section 7.

12.3 If the internal standard calibration procedure is being used, the internal standard must be added to the same extract and mixed thoroughly immediately before injection into the gas chromatograph.

12.4 Inject 2 to 5 μL of the sample extract or standard into the gas chromatograph using the solvent-flush technique.⁹ Smaller (1.0 μL) volumes may be injected if automatic devices are employed. Record the volume injected to the nearest 0.05 μL , the total extract volume, and the resulting peak size in area or peak height units.

12.5 Identify the parameters in the sample by comparing the retention times of the peaks in the sample chromatogram with those of the peaks in standard chromatograms. The width of the retention time window used to make identifications should be based upon measurements of actual retention time variations of standards over the course of a day. Three times the standard deviation of a retention time for a compound can be used to calculate a suggested window size; however, the experience of the analyst should weigh heavily in the interpretation of chromatograms.

12.6 If the response for a peak exceeds the working range of the system, dilute the extract and reanalyze.

12.7 If the measurement of the peak response is prevented by the presence of interferences, further cleanup is required.

13. Calculations

13.1 Determine the concentration of individual compounds in the sample.

13.1.1 If the external standard calibration procedure is used, calculate the amount of material injected from the peak response using the calibration curve or calibration factor determined in Section 7.2.2. The concentration in the sample can be calculated from Equation 2.

$$\text{Concentration } (\mu\text{g/L}) = \frac{(A)(V_t)}{(V_i)(V_s)}$$

Equation 2

where:

A=Amount of material injected (ng).

V_i =Volume of extract injected (μL).

V_t =Volume of total extract (μL).

V_s =Volume of water extracted (mL).

13.1.2 If the internal standard calibration procedure is used, calculate the concentration in the sample using the response factor (RF) determined in Section 7.3.2 and Equation 3.

$$\text{Concentration } (\mu\text{g/L}) = \frac{(A_s)(I_s)}{(A_{is})(\text{RF})(V_o)}$$

Equation 3

where:

A_s =Response for the parameter to be measured.

A_{is} =Response for the internal standard.

I_s =Amount of internal standard added to each extract (μg).

V_o =Volume of water extracted (L).

13.2 Report results in $\mu\text{g/L}$ without correction for recovery data. All QC data obtained should be reported with the sample results.

14. Method Performance

14.1 The method detection limit (MDL) is defined as the minimum concentration of a substance that can be measured and reported with 99% confidence that the value is above zero.¹ The MDL concentrations listed in Table 1 were obtained using reagent water.¹⁰ Similar results were achieved using representative wastewaters. The MDL actually achieved in a given analysis will vary depending on instrument sensitivity and matrix effects.

14.2 This method has been tested for linearity of spike recovery from reagent water and has been demonstrated to be applicable over the concentration range from 7 \times MDL to 1000 \times MDL.¹⁰

14.3 This method was tested by 18 laboratories using reagent water, drinking water, surface water, and three industrial wastewaters spiked at six concentrations over the range 1.0 to 515 $\mu\text{g/L}$.¹¹ Single operator precision, overall precision, and method accuracy were found to be directly related to the concentration of the parameter and essentially independent of the sample matrix. Linear equations to describe these relationships are presented in Table 3.

REFERENCES

- 40 CFR part 136, appendix B.
- "Determination of Nitroaromatic Compounds and Isophorone in Industrial and Municipal Wastewaters," EPA 600/4-82-024, National Technical Information Service, PB82-208398, Springfield, Virginia 22161, May 1982.
- ASTM Annual Book of Standards, Part 31, D3694-78. "Standard Practices for Preparation of Sample Containers and for Preservation of Organic Constituents," American Society for Testing and Materials, Philadelphia.

4. "Carcinogens—Working With Carcinogens," Department of Health, Education, and Welfare, Public Health Service, Center for Disease Control, National Institute for Occupational Safety and Health, Publication No. 77-206, August 1977.
5. "OSHA Safety and Health Standards, General Industry," (29 CFR part 1910), Occupational Safety and Health Administration, OSHA 2206 (Revised, January 1976).
6. "Safety in Academic Chemistry Laboratories," American Chemical Society Publication, Committee on Chemical Safety, 3rd Edition, 1979.
7. Provost, L.P., and Elder, R.S. "Interpretation of Percent Recovery Data," *American Laboratory*, 15, 58-63 (1983). (The value 2.44 used in the equation in Section 8.3.3 is two times the value 1.22 derived in this report.)

8. ASTM Annual Book of Standards, Part 31, D3370-76. "Standard Practices for Sampling Water," American Society for Testing and Materials, Philadelphia.
9. Burke, J.A. "Gas Chromatography for Pesticide Residue Analysis; Some Practical Aspects," *Journal of the Association of Official Analytical Chemists*, 48, 1037 (1965).
10. "Determination of Method Detection Limit and Analytical Curve for EPA Method 609—Nitroaromatics and Isophorone," Special letter report for EPA Contract 68-03-2624, U.S. Environmental Protection Agency, Environmental Monitoring and Support Laboratory, Cincinnati, Ohio 45268, June 1980.
11. "EPA Method Study 19, Method 609 (Nitroaromatics and Isophorone)," EPA 600/4-84-018, National Technical Information Service, PB84-176908, Springfield, Virginia 22161, March 1984.

TABLE 1—CHROMATOGRAPHIC CONDITIONS AND METHOD DETECTION LIMITS

| Parameter | Retention time (min) | | Method detection limit (µg/L) | |
|--------------------------|----------------------|--------|-------------------------------|-------|
| | Col. 1 | Col. 2 | ECDGC | FIDGC |
| Nitrobenzene | 3.31 | 4.31 | 13.7 | 3.6 |
| 2,6-Dinitrotoluene | 3.52 | 4.75 | 0.01 | — |
| Isophorone | 4.49 | 5.72 | 15.7 | 5.7 |
| 2,4-Dinitrotoluene | 5.35 | 6.54 | 0.02 | — |

AAColumn 1 conditions: Gas-Chrom Q (80/100 mesh) coated with 1.95% QF-1/1.5% OV-17 packed in a 1.2 m long x 2 mm or 4 mm ID glass column. A 2 mm ID column and nitrogen carrier gas at 44 mL/min flow rate were used when determining isophorone and nitrobenzene by FIDGC. The column temperature was held isothermal at 85 °C. A 4 mm ID column and 10% methane/90% argon carrier gas at 44 mL/min flow rate were used when determining the dinitrotoluenes by ECDGC. The column temperature was held isothermal at 145 °C.

AAColumn 2 conditions: Gas-Chrom Q (80/100 mesh) coated with 3% OV-101 packed in a 3.0 m long x 2 mm or 4 mm ID glass column. A 2 mm ID column and nitrogen carrier gas at 44 mL/min flow rate were used when determining isophorone and nitrobenzene by FIDGC. The column temperature was held isothermal at 100 °C. A 4 mm ID column and 10% methane/90% argon carrier gas at 44 mL/min flow rate were used when determining the dinitrotoluenes by ECDGC. The column temperature was held isothermal at 150 °C.

TABLE 2—QC ACCEPTANCE CRITERIA—METHOD 609

| Parameter | Test Conc. (µg/L) | Limit for s (µg/L) | Range for \bar{X} (µg/L) | Range for P, P _s (%) |
|--------------------------|-------------------|--------------------|----------------------------|---------------------------------|
| 2,4-Dinitrotoluene | 20 | 5.1 | 3.6-22.8 | 6-125 |
| 2,6-Dinitrotoluene | 20 | 4.8 | 3.8-23.0 | 8-126 |
| Isophorone | 100 | 32.3 | 8.0-100.0 | D-117 |
| Nitrobenzene | 100 | 33.3 | 25.7-100.0 | 6-118 |

s=Standard deviation of four recovery measurements, in µg/L (Section 8.2.4).
 \bar{X} =Average recovery for four recovery measurements, in µg/L (Section 8.2.4).
 P, P_s=Percent recovery measured (Section 8.3.2, Section 8.4.2).
 D=Detected; result must be greater than zero.

NOTE: These criteria are based directly upon the method performance data in Table 3. Where necessary, the limits for recovery have been broadened to assure applicability of the limits to concentrations below those used to develop Table 3.

TABLE 3—METHOD ACCURACY AND PRECISION AS FUNCTIONS OF CONCENTRATION—METHOD 609

| Parameter | Accuracy, as recovery, \bar{X} (µg/L) | Single analyst precision, s_r (µg/L) | Overall precision, S' (µg/L) |
|--------------------------|---|--|--------------------------------|
| 2,4-Dinitrotoluene | 0.65C+0.22 | 0.20 \bar{X} +0.08 | 0.37 \bar{X} - 0.07 |
| 2,6-Dinitrotoluene | 0.66C+0.20 | 0.19 \bar{X} +0.06 | 0.36 \bar{X} - 0.00 |
| Isophorone | 0.49C+2.93 | 0.28 \bar{X} +2.77 | 0.46 \bar{X} +0.31 |
| Nitrobenzene | 0.60C+2.00 | 0.25 \bar{X} +2.53 | 0.37 \bar{X} - 0.78 |

\bar{X} '=Expected recovery for one or more measurements of a sample containing a concentration of C, in µg/L.
 s_r '=Expected single analyst standard deviation of measurements at an average concentration found of \bar{X} , in µg/L.
 S' =Expected interlaboratory standard deviation of measurements at an average concentration found of \bar{X} , in µg/L.
 C=True value for the concentration, in µg/L.
 \bar{X} =Average recovery found for measurements of samples containing a concentration of C, in µg/L.

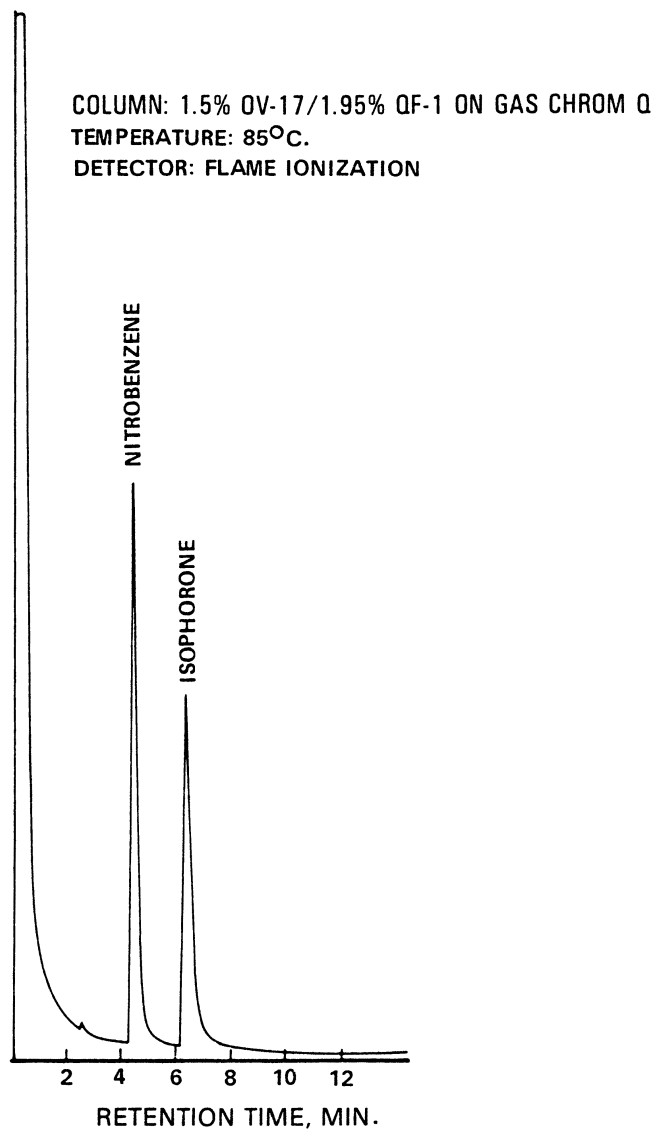

Figure 1. Gas chromatogram of nitrobenzene and isophorone.

COLUMN: 1.5% OV-17/1.95% QF-1 ON GAS CHROM Q
TEMPERATURE: 145°C.
DETECTOR: ELECTRON CAPTURE

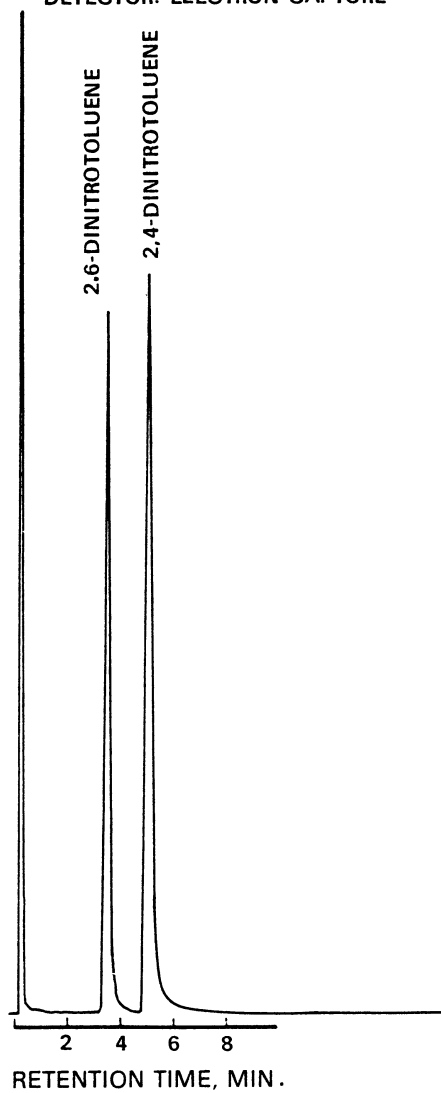

Figure 2. Gas chromatogram of dinitrotoluenes.

METHOD 610—POLYNUCLEAR AROMATIC
HYDROCARBONS

1. Scope and Application

1.1 This method covers the determination of certain polynuclear aromatic hydrocarbons (PAH). The following parameters can be determined by this method:

| Parameter | STORET No. | CAS No. |
|------------------------------|------------|----------|
| Acenaphthene | 34205 | 83-32-9 |
| Acenaphthylene | 34200 | 208-96-8 |
| Anthracene | 34220 | 120-12-7 |
| Benzo(a)anthracene | 34526 | 56-55-3 |
| Benzo(a)pyrene | 34247 | 50-32-8 |
| Benzo(b)fluoranthene | 34230 | 205-99-2 |
| Benzo(ghi)perylene | 34521 | 191-24-2 |
| Benzo(k)fluoranthene | 34242 | 207-08-9 |
| Chrysene | 34320 | 218-01-9 |
| Dibenzo(a,h)anthracene | 34556 | 53-70-3 |
| Fluoranthene | 34376 | 206-44-0 |
| Fluorene | 34381 | 86-73-7 |
| Indeno(1,2,3-cd)pyrene | 34403 | 193-39-5 |
| Naphthalene | 34696 | 91-20-3 |
| Phenanthrene | 34461 | 85-01-8 |
| Pyrene | 34469 | 129-00-0 |

1.2 This is a chromatographic method applicable to the determination of the compounds listed above in municipal and industrial discharges as provided under 40 CFR 136.1. When this method is used to analyze unfamiliar samples for any or all of the compounds above, compound identifications should be supported by at least one additional qualitative technique. Method 625 provides gas chromatograph/mass spectrometer (GC/MS) conditions appropriate for the qualitative and quantitative confirmation of results for many of the parameters listed above, using the extract produced by this method.

1.3 This method provides for both high performance liquid chromatographic (HPLC) and gas chromatographic (GC) approaches for the determination of PAHs. The gas chromatographic procedure does not adequately resolve the following four pairs of compounds: Anthracene and phenanthrene; chrysene and benzo(a)anthracene; benzo(b)fluoranthene and benzo(k)fluoranthene; and dibenzo(a,h)anthracene and indeno(1,2,3-cd)pyrene. Unless the purpose for the analysis can be served by reporting the sum of an unresolved pair, the liquid chromatographic approach must be used for these compounds. The liquid chromatographic method does resolve all 16 of the PAHs listed.

1.4 The method detection limit (MDL, defined in Section 15.1)¹ for each parameter is listed in Table 1. The MDL for a specific wastewater may differ from those listed, depending upon the nature of interferences in the sample matrix.

1.5 The sample extraction and concentration steps in this method are essentially the same as in Methods 606, 608, 609, 611, and 612.

Thus, a single sample may be extracted to measure the parameters included in the scope of each of these methods. When cleanup is required, the concentration levels must be high enough to permit selecting aliquots, as necessary, to apply appropriate cleanup procedures. Selection of the aliquots must be made prior to the solvent exchange steps of this method. The analyst is allowed the latitude, under Sections 12 and 13, to select chromatographic conditions appropriate for the simultaneous measurement of combinations of these parameters.

1.6 Any modification of this method, beyond those expressly permitted, shall be considered as a major modification subject to application and approval of alternate test procedures under 40 CFR 136.4 and 136.5.

1.7 This method is restricted to use by or under the supervision of analysts experienced in the use of HPLC and GC systems and in the interpretation of liquid and gas chromatograms. Each analyst must demonstrate the ability to generate acceptable results with this method using the procedure described in Section 8.2.

2. Summary of Method

2.1 A measured volume of sample, approximately 1-L, is extracted with methylene chloride using a separatory funnel. The methylene chloride extract is dried and concentrated to a volume of 10 mL or less. The extract is then separated by HPLC or GC. Ultraviolet (UV) and fluorescence detectors are used with HPLC to identify and measure the PAHs. A flame ionization detector is used with GC.²

2.2 The method provides a silica gel column cleanup procedure to aid in the elimination of interferences that may be encountered.

3. Interferences

3.1 Method interferences may be caused by contaminants in solvents, reagents, glassware, and other sample processing hardware that lead to discrete artifacts and/or elevated baselines in the chromatograms. All of these materials must be routinely demonstrated to be free from interferences under the conditions of the analysis by running laboratory reagent blanks as described in Section 8.1.3.

3.1.1 Glassware must be scrupulously cleaned.³ Clean all glassware as soon as possible after use by rinsing with the last solvent used in it. Solvent rinsing should be followed by detergent washing with hot water, and rinses with tap water and distilled water. The glassware should then be drained dry, and heated in a muffle furnace at 400°C for 15 to 30 min. Some thermally stable materials, such as PCBs, may not be eliminated by this treatment. Solvent rinses with acetone and pesticide quality hexane may be

substituted for the muffle furnace heating. Thorough rinsing with such solvents usually eliminates PCB interference. Volumetric ware should not be heated in a muffle furnace. After drying and cooling, glassware should be sealed and stored in a clean environment to prevent any accumulation of dust or other contaminants. Store inverted or capped with aluminum foil.

3.1.2 The use of high purity reagents and solvents helps to minimize interference problems. Purification of solvents by distillation in all-glass systems may be required.

3.2 Matrix interferences may be caused by contaminants that are co-extracted from the sample. The extent of matrix interferences will vary considerably from source to source, depending upon the nature and diversity of the industrial complex or municipality being sampled. The cleanup procedure in Section 11 can be used to overcome many of these interferences, but unique samples may require additional cleanup approaches to achieve the MDL listed in Table 1.

3.3 The extent of interferences that may be encountered using liquid chromatographic techniques has not been fully assessed. Although the HPLC conditions described allow for a unique resolution of the specific PAH compounds covered by this method, other PAH compounds may interfere.

4. Safety

4.1 The toxicity or carcinogenicity of each reagent used in this method have not been precisely defined; however, each chemical compound should be treated as a potential health hazard. From this viewpoint, exposure to these chemicals must be reduced to the lowest possible level by whatever means available. The laboratory is responsible for maintaining a current awareness file of OSHA regulations regarding the safe handling of the chemicals specified in this method. A reference file of material data handling sheets should also be made available to all personnel involved in the chemical analysis. Additional references to laboratory safety are available and have been identified⁴⁻⁶ for the information of the analyst.

4.2 The following parameters covered by this method have been tentatively classified as known or suspected, human or mammalian carcinogens: benzo(a)anthracene, benzo(a)pyrene, and dibenzo(a,h)-anthracene. Primary standards of these toxic compounds should be prepared in a hood. A NIOSH/MESA approved toxic gas respirator should be worn when the analyst handles high concentrations of these toxic compounds.

5. Apparatus and Materials

5.1 Sampling equipment, for discrete or composite sampling.

5.1.1 Grab sample bottle—1-L or 1-qt, amber glass, fitted with a screw cap lined

with Teflon. Foil may be substituted for Teflon if the sample is not corrosive. If amber bottles are not available, protect samples from light. The bottle and cap liner must be washed, rinsed with acetone or methylene chloride, and dried before use to minimize contamination.

5.1.2 Automatic sampler (optional)—The sampler must incorporate glass sample containers for the collection of a minimum of 250 mL of sample. Sample containers must be kept refrigerated at 4°C and protected from light during compositing. If the sampler uses a peristaltic pump, a minimum length of compressible silicone rubber tubing may be used. Before use, however, the compressible tubing should be thoroughly rinsed with methanol, followed by repeated rinsings with distilled water to minimize the potential for contamination of the sample. An integrating flow meter is required to collect flow proportional composites.

5.2 Glassware (All specifications are suggested. Catalog numbers are included for illustration only.):

5.2.1 Separatory funnel—2-L, with Teflon stopcock.

5.2.2 Drying column—Chromatographic column, approximately 400 mm long × 19 mm ID, with coarse frit filter disc.

5.2.3 Concentrator tube, Kuderna-Danish—10-mL, graduated (Kontes K-570050-1025 or equivalent). Calibration must be checked at the volumes employed in the test. Ground glass stopper is used to prevent evaporation of extracts.

5.2.4 Evaporative flask, Kuderna-Danish—500-mL (Kontes K-570001-0500 or equivalent). Attach to concentrator tube with springs.

5.2.5 Snyder column, Kuderna-Danish—Three-ball macro (Kontes K-503000-0121 or equivalent).

5.2.6 Snyder column, Kuderna-Danish—Two-ball micro (Kontes K-569001-0219 or equivalent).

5.2.7 Vials—10 to 15-mL, amber glass, with Teflon-lined screw cap.

5.2.8 Chromatographic column—250 mm long × 10 mm ID, with coarse frit filter disc at bottom and Teflon stopcock.

5.3 Boiling chips—Approximately 10/40 mesh. Heat to 400 °C for 30 min or Soxhlet extract with methylene chloride.

5.4 Water bath—Heated, with concentric ring cover, capable of temperature control (± 2 °C). The bath should be used in a hood.

5.5 Balance—Analytical, capable of accurately weighing 0.0001 g.

5.6 High performance liquid chromatograph (HPLC)—An analytical system complete with column supplies, high pressure syringes, detectors, and compatible strip-chart recorder. A data system is recommended for measuring peak areas and retention times.

5.6.1 Gradient pumping system—Constant flow.

5.6.2 Reverse phase column—HC-ODS Sil-X, 5 micron particle diameter, in a 25 cm × 2.6 mm ID stainless steel column (Perkin Elmer No. 089-0716 or equivalent). This column was used to develop the method performance statements in Section 15. Guidelines for the use of alternate column packings are provided in Section 12.2.

5.6.3 Detectors—Fluorescence and/or UV detectors. The fluorescence detector is used for excitation at 280 nm and emission greater than 389 nm cutoff (Corning 3-75 or equivalent). Fluorometers should have dispersive optics for excitation and can utilize either filter or dispersive optics at the emission detector. The UV detector is used at 254 nm and should be coupled to the fluorescence detector. These detectors were used to develop the method performance statements in Section 15. Guidelines for the use of alternate detectors are provided in Section 12.2.

5.7 Gas chromatograph—An analytical system complete with temperature programmable gas chromatograph suitable for on-column or splitless injection and all required accessories including syringes, analytical columns, gases, detector, and strip-chart recorder. A data system is recommended for measuring peak areas.

5.7.1 Column—1.8 m long × 2 mm ID glass, packed with 3% OV-17 on Chromosorb W-AW-DCMS (100/120 mesh) or equivalent. This column was used to develop the retention time data in Table 2. Guidelines for the use of alternate column packings are provided in Section 13.3.

5.7.2 Detector—Flame ionization detector. This detector has proven effective in the analysis of wastewaters for the parameters listed in the scope (Section 1.1), excluding the four pairs of unresolved compounds listed in Section 1.3. Guidelines for the use of alternate detectors are provided in Section 13.3.

6. Reagents

6.1 Reagent water—Reagent water is defined as a water in which an interferent is not observed at the MDL of the parameters of interest.

6.2 Sodium thiosulfate—(ACS) Granular.

6.3 Cyclohexane, methanol, acetone, methylene chloride, pentane—Pesticide quality or equivalent.

6.4 Acetonitrile—HPLC quality, distilled in glass.

6.5 Sodium sulfate—(ACS) Granular, anhydrous. Purify by heating at 400 °C for 4 h in a shallow tray.

6.6 Silica gel—100/200 mesh, desiccant, Davison, grade-923 or equivalent. Before use, activate for at least 16 h at 130 °C in a shallow glass tray, loosely covered with foil.

6.7 Stock standard solutions (1.00 µg/µL)—Stock standard solutions can be prepared from pure standard materials or purchased as certified solutions.

6.7.1 Prepare stock standard solutions by accurately weighing about 0.0100 g of pure material. Dissolve the material in acetonitrile and dilute to volume in a 10-mL volumetric flask. Larger volumes can be used at the convenience of the analyst. When compound purity is assayed to be 96% or greater, the weight can be used without correction to calculate the concentration of the stock standard. Commercially prepared stock standards can be used at any concentration if they are certified by the manufacturer or by an independent source.

6.7.2 Transfer the stock standard solutions into Teflon-sealed screw-cap bottles. Store at 4 °C and protect from light. Stock standard solutions should be checked frequently for signs of degradation or evaporation, especially just prior to preparing calibration standards from them.

6.7.3 Stock standard solutions must be replaced after six months, or sooner if comparison with check standards indicates a problem.

6.8 Quality control check sample concentrate—See Section 8.2.1.

7. Calibration

7.1 Establish liquid or gas chromatographic operating conditions equivalent to those given in Table 1 or 2. The chromatographic system can be calibrated using the external standard technique (Section 7.2) or the internal standard technique (Section 7.3).

7.2 External standard calibration procedure:

7.2.1 Prepare calibration standards at a minimum of three concentration levels for each parameter of interest by adding volumes of one or more stock standards to a volumetric flask and diluting to volume with acetonitrile. One of the external standards should be at a concentration near, but above, the MDL (Table 1) and the other concentrations should correspond to the expected range of concentrations found in real samples or should define the working range of the detector.

7.2.2 Using injections of 5 to 25 µL for HPLC and 2 to 5 µL for GC, analyze each calibration standard according to Section 12 or 13, as appropriate. Tabulate peak height or area responses against the mass injected. The results can be used to prepare a calibration curve for each compound. Alternatively, if the ratio of response to amount injected (calibration factor) is a constant over the working range (<10% relative standard deviation, RSD), linearity through the origin can be assumed and the average ratio or calibration factor can be used in place of a calibration curve.

7.3 Internal standard calibration procedure—To use this approach, the analyst must select one or more internal standards that are similar in analytical behavior to the

compounds of interest. The analyst must further demonstrate that the measurement of the internal standard is not affected by method or matrix interferences. Because of these limitations, no internal standard can be suggested that is applicable to all samples.

7.3.1 Prepare calibration standards at a minimum of three concentration levels for each parameter of interest by adding volumes of one or more stock standards to a volumetric flask. To each calibration standard, add a known constant amount of one or more internal standards, and dilute to volume with acetonitrile. One of the standards should be at a concentration near, but above, the MDL and the other concentrations should correspond to the expected range of concentrations found in real samples or should define the working range of the detector.

7.3.2 Using injections of 5 to 25 μL for HPLC and 2 to 5 μL for GC, analyze each calibration standard according to Section 12 or 13, as appropriate. Tabulate peak height or area responses against concentration for each compound and internal standard. Calculate response factors (RF) for each compound using Equation 1.

$$\text{RF} = \frac{(A_s)(C_{is})}{(A_{is})(C_s)}$$

Equation 1

where:

A_s =Response for the parameter to be measured.

A_{is} =Response for the internal standard.

C_{is} =Concentration of the internal standard ($\mu\text{g/L}$).

C_s =Concentration of the parameter to be measured ($\mu\text{g/L}$).

If the RF value over the working range is a constant (<10% RSD), the RF can be assumed to be invariant and the average RF can be used for calculations. Alternatively, the results can be used to plot a calibration curve of response ratios, A_s/A_{is} , vs. RF.

7.4 The working calibration curve, calibration factor, or RF must be verified on each working day by the measurement of one or more calibration standards. If the response for any parameter varies from the predicted response by more than $\pm 15\%$, the test must be repeated using a fresh calibration standard. Alternatively, a new calibration curve must be prepared for that compound.

7.5 Before using any cleanup procedure, the analyst must process a series of calibration standards through the procedure to validate elution patterns and the absence of interferences from the reagents.

8. Quality Control

8.1 Each laboratory that uses this method is required to operate a formal quality control program. The minimum requirements of this program consist of an initial demonstration of laboratory capability and an ongoing analysis of spiked samples to evaluate and document data quality. The laboratory must maintain records to document the quality of data that is generated. Ongoing data quality checks are compared with established performance criteria to determine if the results of analyses meet the performance characteristics of the method. When results of sample spikes indicate atypical method performance, a quality control check standard must be analyzed to confirm that the measurements were performed in an in-control mode of operation.

8.1.1 The analyst must make an initial, one-time, demonstration of the ability to generate acceptable accuracy and precision with this method. This ability is established as described in Section 8.2.

8.1.2 In recognition of advances that are occurring in chromatography, the analyst is permitted certain options (detailed in Sections 10.4, 11.1, 12.2, and 13.3) to improve the separations or lower the cost of measurements. Each time such a modification is made to the method, the analyst is required to repeat the procedure in Section 8.2.

8.1.3 Before processing any samples the analyst must analyze a reagent water blank to demonstrate that interferences from the analytical system and glassware are under control. Each time a set of samples is extracted or reagents are changed a reagent water blank must be processed as a safeguard against laboratory contamination.

8.1.4 The laboratory must, on an ongoing basis, spike and analyze a minimum of 10% of all samples to monitor and evaluate laboratory data quality. This procedure is described in Section 8.3.

8.1.5 The laboratory must, on an ongoing basis, demonstrate through the analyses of quality control check standards that the operation of the measurement system is in control. This procedure is described in Section 8.4. The frequency of the check standard analyses is equivalent to 10% of all samples analyzed but may be reduced if spike recoveries from samples (Section 8.3) meet all specified quality control criteria.

8.1.6 The laboratory must maintain performance records to document the quality of data that is generated. This procedure is described in Section 8.5.

8.2 To establish the ability to generate acceptable accuracy and precision, the analyst must perform the following operations.

8.2.1 A quality control (QC) check sample concentrate is required containing each parameter of interest at the following concentrations in acetonitrile: 100 $\mu\text{g/mL}$ of any

of the six early-eluting PAHs (naphthalene, acenaphthylene, acenaphthene, fluorene, phenanthrene, and anthracene); 5 µg/mL of benzo(k)fluoranthene; and 10 µg/mL of any of the other PAHs. The QC check sample concentrate must be obtained from the U.S. Environmental Protection Agency, Environmental Monitoring and Support Laboratory in Cincinnati, Ohio, if available. If not available from that source, the QC check sample concentrate must be obtained from another external source. If not available from either source above, the QC check sample concentrate must be prepared by the laboratory using stock standards prepared independently from those used for calibration.

8.2.2 Using a pipet, prepare QC check samples at the test concentrations shown in Table 3 by adding 1.00 mL of QC check sample concentrate to each of four 1-L aliquots of reagent water.

8.2.3 Analyze the well-mixed QC check samples according to the method beginning in Section 10.

8.2.4 Calculate the average recovery (\bar{X}) in µg/L, and the standard deviation of the recovery (s) in µg/L, for each parameter using the four results.

8.2.5 For each parameter compare s and \bar{X} with the corresponding acceptance criteria for precision and accuracy, respectively, found in Table 3. If s and \bar{X} for all parameters of interest meet the acceptance criteria, the system performance is acceptable and analysis of actual samples can begin. If any individual s exceeds the precision limit or any individual \bar{X} falls outside the range for accuracy, the system performance is unacceptable for that parameter.

NOTE: The large number of parameters in Table 3 present a substantial probability that one or more will fail at least one of the acceptance criteria when all parameters are analyzed.

8.2.6 When one or more of the parameters tested fail at least one of the acceptance criteria, the analyst must proceed according to Section 8.2.6.1 or 8.2.6.2.

8.2.6.1 Locate and correct the source of the problem and repeat the test for all parameters of interest beginning with Section 8.2.2.

8.2.6.2 Beginning with Section 8.2.2, repeat the test only for those parameters that failed to meet criteria. Repeated failure, however, will confirm a general problem with the measurement system. If this occurs, locate and correct the source of the problem and repeat the test for all compounds of interest beginning with Section 8.2.2.

8.3 The laboratory must, on an ongoing basis, spike at least 10% of the samples from each sample site being monitored to assess accuracy. For laboratories analyzing one to ten samples per month, at least one spiked sample per month is required.

8.3.1 The concentration of the spike in the sample should be determined as follows:

8.3.1.1 If, as in compliance monitoring, the concentration of a specific parameter in the sample is being checked against a regulatory concentration limit, the spike should be at that limit or 1 to 5 times higher than the background concentration determined in Section 8.3.2, whichever concentration would be larger.

8.3.1.2 If the concentration of a specific parameter in the sample is not being checked against a limit specific to that parameter, the spike should be at the test concentration in Section 8.2.2 or 1 to 5 times higher than the background concentration determined in Section 8.3.2, whichever concentration would be larger.

8.3.1.3 If it is impractical to determine background levels before spiking (e.g., maximum holding times will be exceeded), the spike concentration should be (1) the regulatory concentration limit, if any; or, if none, (2) the larger of either 5 times higher than the expected background concentration or the test concentration in Section 8.2.2.

8.3.2 Analyze one sample aliquot to determine the background concentration (B) of each parameter. If necessary, prepare a new QC check sample concentrate (Section 8.2.1) appropriate for the background concentrations in the sample. Spike a second sample aliquot with 1.0 mL of the QC check sample concentrate and analyze it to determine the concentration after spiking (A) of each parameter. Calculate each percent recovery (P) as $100(A - B)/T$, where T is the known true value of the spike.

8.3.3 Compare the percent recovery (P) for each parameter with the corresponding QC acceptance criteria found in Table 3. These acceptance criteria were calculated to include an allowance for error in measurement of both the background and spike concentrations, assuming a spike to background ratio of 5:1. This error will be accounted for to the extent that the analyst's spike to background ratio approaches 5:1.⁷ If spiking was performed at a concentration lower than the test concentration in Section 8.2.2, the analyst must use either the QC acceptance criteria in Table 3, or optional QC acceptance criteria calculated for the specific spike concentration. To calculate optional acceptance criteria for the recovery of a parameter: (1) Calculate accuracy (X') using the equation in Table 4, substituting the spike concentration (T) for C; (2) calculate overall precision (S') using the equation in Table 4, substituting X' for \bar{X} ; (3) calculate the range for recovery at the spike concentration as $(100 X'/T) \pm 2.44(100 S'/T)\%$.⁷

8.3.4 If any individual P falls outside the designated range for recovery, that parameter has failed the acceptance criteria. A check standard containing each parameter

that failed the criteria must be analyzed as described in Section 8.4.

8.4 If any parameter fails the acceptance criteria for recovery in Section 8.3, a QC check standard containing each parameter that failed must be prepared and analyzed.

NOTE: The frequency for the required analysis of a QC check standard will depend upon the number of parameters being simultaneously tested, the complexity of the sample matrix, and the performance of the laboratory. If the entire list of parameters in Table 3 must be measured in the sample in Section 8.3, the probability that the analysis of a QC check standard will be required is high. In this case the QC check standard should be routinely analyzed with the spike sample.

8.4.1 Prepare the QC check standard by adding 1.0 mL of QC check sample concentrate (Section 8.2.1 or 8.3.2) to 1 L of reagent water. The QC check standard needs only to contain the parameters that failed criteria in the test in Section 8.3.

8.4.2 Analyze the QC check standard to determine the concentration measured (A) of each parameter. Calculate each percent recovery (P_s) as $100(A/T)\%$, where T is the true value of the standard concentration.

8.4.3 Compare the percent recovery (P_s) for each parameter with the corresponding QC acceptance criteria found in Table 3. Only parameters that failed the test in Section 8.3 need to be compared with these criteria. If the recovery of any such parameter falls outside the designated range, the laboratory performance for that parameter is judged to be out of control, and the problem must be immediately identified and corrected. The analytical result for that parameter in the unspiked sample is suspect and may not be reported for regulatory compliance purposes.

8.5 As part of the QC program for the laboratory, method accuracy for wastewater samples must be assessed and records must be maintained. After the analysis of five spiked wastewater samples as in Section 8.3, calculate the average percent recovery (\bar{P}) and the standard deviation of the percent recovery (s_p). Express the accuracy assessment as a percent recovery interval from $\bar{P}-2s_p$ to $\bar{P}+2s_p$. If $\bar{P}=90\%$ and $s_p=10\%$, for example, the accuracy interval is expressed as 70–110%. Update the accuracy assessment for each parameter on a regular basis (e.g. after each five to ten new accuracy measurements).

8.6 It is recommended that the laboratory adopt additional quality assurance practices for use with this method. The specific practices that are most productive depend upon the needs of the laboratory and the nature of the samples. Field duplicates may be analyzed to assess the precision of the environmental measurements. When doubt exists over the identification of a peak on the chromatogram, confirmatory techniques such as gas chromatography with a dissimilar column, specific element detector, or mass

spectrometer must be used. Whenever possible, the laboratory should analyze standard reference materials and participate in relevant performance evaluation studies.

9. Sample Collection, Preservation, and Handling

9.1 Grab samples must be collected in glass containers. Conventional sampling practices⁸ should be followed, except that the bottle must not be prerinsed with sample before collection. Composite samples should be collected in refrigerated glass containers in accordance with the requirements of the program. Automatic sampling equipment must be as free as possible of Tygon tubing and other potential sources of contamination.

9.2 All samples must be iced or refrigerated at 4°C from the time of collection until extraction. PAHs are known to be light sensitive; therefore, samples, extracts, and standards should be stored in amber or foil-wrapped bottles in order to minimize photolytic decomposition. Fill the sample bottles and, if residual chlorine is present, add 80 mg of sodium thiosulfate per liter of sample and mix well. EPA Methods 330.4 and 330.5 may be used for measurement of residual chlorine.⁹ Field test kits are available for this purpose.

9.3 All samples must be extracted within 7 days of collection and completely analyzed within 40 days of extraction.²

10. Sample Extraction

10.1 Mark the water meniscus on the side of the sample bottle for later determination of sample volume. Pour the entire sample into a 2-L separatory funnel.

10.2 Add 60 mL of methylene chloride to the sample bottle, seal, and shake 30 s to rinse the inner surface. Transfer the solvent to the separatory funnel and extract the sample by shaking the funnel for 2 min. with periodic venting to release excess pressure. Allow the organic layer to separate from the water phase for a minimum of 10 min. If the emulsion interface between layers is more than one-third the volume of the solvent layer, the analyst must employ mechanical techniques to complete the phase separation. The optimum technique depends upon the sample, but may include stirring, filtration of the emulsion through glass wool, centrifugation, or other physical methods. Collect the methylene chloride extract in a 250-mL Erlenmeyer flask.

10.3 Add a second 60-mL volume of methylene chloride to the sample bottle and repeat the extraction procedure a second time, combining the extracts in the Erlenmeyer flask. Perform a third extraction in the same manner.

10.4 Assemble a Kuderna-Danish (K-D) concentrator by attaching a 10-mL concentrator tube to a 500-mL evaporative flask. Other concentration devices or techniques may be used in place of the K-D concentrator if the requirements of Section 8.2 are met.

10.5 Pour the combined extract through a solvent-rinsed drying column containing about 10 cm of anhydrous sodium sulfate, and collect the extract in the K-D concentrator. Rinse the Erlenmeyer flask and column with 20 to 30 mL of methylene chloride to complete the quantitative transfer.

10.6 Add one or two clean boiling chips to the evaporative flask and attach a three-ball Snyder column. Prewet the Snyder column by adding about 1 mL of methylene chloride to the top. Place the K-D apparatus on a hot water bath (60 to 65 °C) so that the concentrator tube is partially immersed in the hot water, and the entire lower rounded surface of the flask is bathed with hot vapor. Adjust the vertical position of the apparatus and the water temperature as required to complete the concentration in 15 to 20 min. At the proper rate of distillation the balls of the column will actively chatter but the chambers will not flood with condensed solvent. When the apparent volume of liquid reaches 1 mL, remove the K-D apparatus and allow it to drain and cool for at least 10 min.

10.7 Remove the Snyder column and rinse the flask and its lower joint into the concentrator tube with 1 to 2 mL of methylene chloride. A 5-mL syringe is recommended for this operation. Stopper the concentrator tube and store refrigerated if further processing will not be performed immediately. If the extract will be stored longer than two days, it should be transferred to a Teflon-sealed screw-cap vial and protected from light. If the sample extract requires no further cleanup, proceed with gas or liquid chromatographic analysis (Section 12 or 13). If the sample requires further cleanup, proceed to Section 11.

10.8 Determine the original sample volume by refilling the sample bottle to the mark and transferring the liquid to a 1000-mL graduated cylinder. Record the sample volume to the nearest 5 mL.

11. Cleanup and Separation

11.1 Cleanup procedures may not be necessary for a relatively clean sample matrix. If particular circumstances demand the use of a cleanup procedure, the analyst may use the procedure below or any other appropriate procedure. However, the analyst first must demonstrate that the requirements of Section 8.2 can be met using the methods as revised to incorporate the cleanup procedure.

11.2 Before the silica gel cleanup technique can be utilized, the extract solvent must be exchanged to cyclohexane. Add 1 to 10 mL of the sample extract (in methylene chloride) and a boiling chip to a clean K-D

concentrator tube. Add 4 mL of cyclohexane and attach a two-ball micro-Snyder column. Prewet the column by adding 0.5 mL of methylene chloride to the top. Place the micro-K-D apparatus on a boiling (100 °C) water bath so that the concentrator tube is partially immersed in the hot water. Adjust the vertical position of the apparatus and the water temperature as required to complete concentration in 5 to 10 min. At the proper rate of distillation the balls of the column will actively chatter but the chambers will not flood. When the apparent volume of the liquid reaches 0.5 mL, remove the K-D apparatus and allow it to drain and cool for at least 10 min. Remove the micro-Snyder column and rinse its lower joint into the concentrator tube with a minimum amount of cyclohexane. Adjust the extract volume to about 2 mL.

11.3 Silica gel column cleanup for PAHs:

11.3.1 Prepare a slurry of 10 g of activated silica gel in methylene chloride and place this into a 10-mm ID chromatographic column. Tap the column to settle the silica gel and elute the methylene chloride. Add 1 to 2 cm of anhydrous sodium sulfate to the top of the silica gel.

11.3.2 Preelute the column with 40 mL of pentane. The rate for all elutions should be about 2 mL/min. Discard the eluate and just prior to exposure of the sodium sulfate layer to the air, transfer the 2-mL cyclohexane sample extract onto the column using an additional 2 mL cyclohexane to complete the transfer. Just prior to exposure of the sodium sulfate layer to the air, add 25 mL of pentane and continue the elution of the column. Discard this pentane eluate.

11.3.3 Next, elute the column with 25 mL of methylene chloride/pentane (4+6)(V/V) into a 500-mL K-D flask equipped with a 10-mL concentrator tube. Concentrate the collected fraction to less than 10 mL as in Section 10.6. When the apparatus is cool, remove the Snyder column and rinse the flask and its lower joint with pentane. Proceed with HPLC or GC analysis.

12. High Performance Liquid Chromatography

12.1 To the extract in the concentrator tube, add 4 mL of acetonitrile and a new boiling chip, then attach a two-ball micro-Snyder column. Concentrate the solvent as in Section 10.6, except set the water bath at 95 to 100 °C. When the apparatus is cool, remove the micro-Snyder column and rinse its lower joint into the concentrator tube with about 0.2 mL of acetonitrile. Adjust the extract volume to 1.0 mL.

12.2 Table 1 summarizes the recommended operating conditions for the HPLC. Included in this table are retention times, capacity factors, and MDL that can be achieved under these conditions. The UV detector is recommended for the determination of naphthalene, acenaphthylene, acenaphthene, and

fluorene and the fluorescence detector is recommended for the remaining PAHs. Examples of the separations achieved by this HPLC column are shown in Figures 1 and 2. Other HPLC columns, chromatographic conditions, or detectors may be used if the requirements of Section 8.2 are met.

12.3 Calibrate the system daily as described in Section 7.

12.4 If the internal standard calibration procedure is being used, the internal standard must be added to the sample extract and mixed thoroughly immediately before injection into the instrument.

12.5 Inject 5 to 25 μL of the sample extract or standard into the HPLC using a high pressure syringe or a constant volume sample injection loop. Record the volume injected to the nearest 0.1 μL , and the resulting peak size in area or peak height units. Re-equilibrate the HPLC column at the initial gradient conditions for at least 10 min between injections.

12.6 Identify the parameters in the sample by comparing the retention time of the peaks in the sample chromatogram with those of the peaks in standard chromatograms. The width of the retention time window used to make identifications should be based upon measurements of actual retention time variations of standards over the course of a day. Three times the standard deviation of a retention time for a compound can be used to calculate a suggested window size; however, the experience of the analyst should weigh heavily in the interpretation of chromatograms.

12.7 If the response for a peak exceeds the working range of the system, dilute the extract with acetonitrile and reanalyze.

12.8 If the measurement of the peak response is prevented by the presence of interferences, further cleanup is required.

13. Gas Chromatography

13.1 The packed column GC procedure will not resolve certain isomeric pairs as indicated in Section 1.3 and Table 2. The liquid chromatographic procedure (Section 12) must be used for these parameters.

13.2 To achieve maximum sensitivity with this method, the extract must be concentrated to 1.0 mL. Add a clean boiling chip to the methylene chloride extract in the concentrator tube. Attach a two-ball micro-Snyder column. Prewet the micro-Snyder column by adding about 0.5 mL of methylene chloride to the top. Place the micro-K-D apparatus on a hot water bath (60 to 65 $^{\circ}\text{C}$) so that the concentrator tube is partially immersed in the hot water. Adjust the vertical position of the apparatus and the water temperature as required to complete the concentration in 5 to 10 min. At the proper rate of distillation the balls will actively chatter but the chambers will not flood. When the apparent volume of liquid reaches 0.5 mL, re-

move the K-D apparatus and allow it to drain and cool for at least 10 min. Remove the micro-Snyder column and rinse its lower joint into the concentrator tube with a minimum amount of methylene chloride. Adjust the final volume to 1.0 mL and stopper the concentrator tube.

13.3 Table 2 summarizes the recommended operating conditions for the gas chromatograph. Included in this table are retention times that were obtained under these conditions. An example of the separations achieved by this column is shown in Figure 3. Other packed or capillary (open-tubular) columns, chromatographic conditions, or detectors may be used if the requirements of Section 8.2 are met.

13.4 Calibrate the gas chromatographic system daily as described in Section 7.

13.5 If the internal standard calibration procedure is being used, the internal standard must be added to the sample extract and mixed thoroughly immediately before injection into the gas chromatograph.

13.6 Inject 2 to 5 μL of the sample extract or standard into the gas chromatograph using the solvent-flush technique.¹⁰ Smaller (1.0 μL) volumes may be injected if automatic devices are employed. Record the volume injected to the nearest 0.05 μL , and the resulting peak size in area or peak height units.

13.7 Identify the parameters in the sample by comparing the retention times of the peaks in the sample chromatogram with those of the peaks in standard chromatograms. The width of the retention time window used to make identifications should be based upon measurements of actual retention time variations of standards over the course of a day. Three times the standard deviation of a retention time for a compound can be used to calculate a suggested window size; however, the experience of the analyst should weigh heavily in the interpretation of chromatograms.

13.8 If the response for a peak exceeds the working range of the system, dilute the extract and reanalyze.

13.9 If the measurement of the peak response is prevented by the presence of interferences, further cleanup is required.

14. Calculations

14.1 Determine the concentration of individual compounds in the sample.

14.1.1 If the external standard calibration procedure is used, calculate the amount of material injected from the peak response using the calibration curve or calibration factor determined in Section 7.2.2. The concentration in the sample can be calculated from Equation 2.

$$\text{Concentration } (\mu\text{g/L}) = \frac{(A)(V_t)}{(V_i)(V_s)}$$

Equation 2

where:

A=Amount of material injected (ng).

V_i=Volume of extract injected (μL).V_t=Volume of total extract (μL).V_s=Volume of water extracted (mL).

13.1.2 If the internal standard calibration procedure is used, calculate the concentration in the sample using the response factor (RF) determined in Section 7.3.2 and Equation 3.

$$\text{Concentration } (\mu\text{g/L}) = \frac{(A_s)(I_s)}{(A_{is})(RF)(V_o)}$$

Equation 3

where:

A_s=Response for the parameter to be measured.A_{is}=Response for the internal standard.I_s=Amount of internal standard added to each extract (μg).V_o=Volume of water extracted (L).

14.2 Report results in μg/L without correction for recovery data. All QC data obtained should be reported with the sample results.

15. Method Performance

15.1 The method detection limit (MDL) is defined as the minimum concentration of a substance that can be measured and reported with 99% confidence that the value is above zero.¹ The MDL concentrations listed in Table 1 were obtained using reagent water.¹¹ Similar results were achieved using representative wastewaters. MDL for the GC approach were not determined. The MDL actually achieved in a given analysis will vary depending on instrument sensitivity and matrix effects.

15.2 This method has been tested for linearity of spike recovery from reagent water and has been demonstrated to be applicable over the concentration range from 8 × MDL to 800 × MDL¹¹ with the following exception: benzo(ghi)perylene recovery at 80 × and 800 × MDL were low (35% and 45%, respectively).

15.3 This method was tested by 16 laboratories using reagent water, drinking water, surface water, and three industrial wastewaters spiked at six concentrations over the range 0.1 to 425 μg/L.¹² Single operator precision, overall precision, and method accuracy were found to be directly related to the concentration of the parameter and essentially independent of the sample matrix.

Linear equations to describe these relationships are presented in Table 4.

REFERENCES

- 40 CFR part 136, appendix B.
- "Determination of Polynuclear Aromatic Hydrocarbons in Industrial and Municipal Wastewaters," EPA 600/4-82-025, National Technical Information Service, PB82-258799, Springfield, Virginia 22161, June 1982.
- ASTM Annual Book of Standards, Part 31, D3694-78. "Standard Practices for Preparation of Sample Containers and for Preservation of Organic Constituents," American Society for Testing and Materials, Philadelphia.
- "Carcinogens—Working With Carcinogens," Department of Health, Education, and Welfare, Public Health Service, Center for Disease Control, National Institute for Occupational Safety and Health, Publication No. 77-206, August 1977.
- "OSHA Safety and Health Standards, General Industry," (29 CFR part 1910), Occupational Safety and Health Administration, OSHA 2206 (Revised, January 1976).
- "Safety in Academic Chemistry Laboratories," American Chemical Society Publication, Committee on Chemical Safety, 3rd Edition, 1979.
- Provost, L.P., and Elder, R.S. "Interpretation of Percent Recovery Data," *American Laboratory*, 15, 58-63 (1983). (The value 2.44 used in the equation in Section 8.3.3 is two times the value 1.22 derived in this report.)
- ASTM Annual Book of Standards, Part 31, D3370-76. "Standard Practices for Sampling Water," American Society for Testing and Materials, Philadelphia.
- "Methods 330.4 (Titrimetric, DPD-FAS) and 330.5 (Spectrophotometric, DPD) for Chlorine, Total Residual," Methods for Chemical Analysis of Water and Wastes, EPA-600/4-79-020, U.S. Environmental Protection Agency, Environmental Monitoring and Support Laboratory, Cincinnati, Ohio 45268, March 1979.
- Burke, J.A. "Gas Chromatography for Pesticide Residue Analysis; Some Practical Aspects," *Journal of the Association of Official Analytical Chemists*, 48, 1037 (1965).
- Cole, T., Riggan, R., and Glaser, J. "Evaluation of Method Detection Limits and Analytical Curve for EPA Method 610—PNAs," International Symposium on Polynuclear Aromatic Hydrocarbons, 5th, Battelle's Columbus Laboratories, Columbus, Ohio (1980).
- "EPA Method Study 20, Method 610 (PNA's)," EPA 600/4-84-063, National Technical Information Service, PB84-211614, Springfield, Virginia 22161, June 1984.

TABLE 1—HIGH PERFORMANCE LIQUID CHROMATOGRAPHY CONDITIONS AND METHOD DETECTION LIMITS

| Parameter | Retention time (min) | Column capacity factor (k') | Method detection limit (µg/L) ^a |
|------------------------|----------------------|-----------------------------|--|
| Naphthalene | 16.6 | 12.2 | 1.8 |
| Acenaphthylene | 18.5 | 13.7 | 2.3 |
| Acenaphthene | 20.5 | 15.2 | 1.8 |
| Fluorene | 21.2 | 15.8 | 0.21 |
| Phenanthrene | 22.1 | 16.6 | 0.64 |
| Anthracene | 23.4 | 17.6 | 0.66 |
| Fluoranthene | 24.5 | 18.5 | 0.21 |
| Pyrene | 25.4 | 19.1 | 0.27 |
| Benzo(a)anthracene | 28.5 | 21.6 | 0.013 |
| Chrysene | 29.3 | 22.2 | 0.15 |
| Benzo(b)fluoranthene | 31.6 | 24.0 | 0.018 |
| Benzo(k)fluoranthene | 32.9 | 25.1 | 0.017 |
| Benzo(a)pyrene | 33.9 | 25.9 | 0.023 |
| Dibenzo(a,h)anthracene | 35.7 | 27.4 | 0.030 |
| Benzo(ghi)perylene | 36.3 | 27.8 | 0.076 |
| Indeno(1,2,3-cd)pyrene | 37.4 | 28.7 | 0.043 |

AAAHPLC column conditions: Reverse phase HC-ODS Sil-X, 5 micron particle size, in a 25 cm x 2.6 mm ID stainless steel column. Isocratic elution for 5 min. using acetonitrile/water (4+6), then linear gradient elution to 100% acetonitrile over 25 min. at 0.5 mL/min flow rate. If columns having other internal diameters are used, the flow rate should be adjusted to maintain a linear velocity of 2 mm/sec.

^aThe MDL for naphthalene, acenaphthylene, acenaphthene, and fluorene were determined using a UV detector. All others were determined using a fluorescence detector.

TABLE 2—GAS CHROMATOGRAPHIC CONDITIONS AND RETENTION TIMES

| Parameter | Retention time (min) |
|----------------------|----------------------|
| Naphthalene | 4.5 |
| Acenaphthylene | 10.4 |
| Acenaphthene | 10.8 |
| Fluorene | 12.6 |
| Phenanthrene | 15.9 |
| Anthracene | 15.9 |
| Fluoranthene | 19.8 |
| Pyrene | 20.6 |
| Benzo(a)anthracene | 24.7 |
| Chrysene | 24.7 |
| Benzo(b)fluoranthene | 28.0 |

TABLE 2—GAS CHROMATOGRAPHIC CONDITIONS AND RETENTION TIMES—Continued

| Parameter | Retention time (min) |
|------------------------|----------------------|
| Benzo(k)fluoranthene | 28.0 |
| Benzo(a)pyrene | 29.4 |
| Dibenzo(a,h)anthracene | 36.2 |
| Indeno(1,2,3-cd)pyrene | 36.2 |
| Benzo(ghi)perylene | 38.6 |

GC Column conditions: Chromosorb W-AW-DCMS (100/120 mesh) coated with 3% OV-17 packed in a 1.8 x 2 mm ID glass column with nitrogen carrier gas at 40 mL/min. flow rate. Column temperature was held at 100 °C for 4 min., then programmed at 8 °C/min. to a final hold at 280 °C.

TABLE 3—QC ACCEPTANCE CRITERIA—METHOD 610

| Parameter | Test conc. (µg/L) | Limit for s (µg/L) | Range for X̄ (µg/L) | Range for P, P _s (%) |
|-------------------------|-------------------|--------------------|---------------------|---------------------------------|
| Acenaphthene | 100 | 40.3 | D-105.7 | D-124 |
| Acenaphthylene | 100 | 45.1 | 22.1-112.1 | D-139 |
| Anthracene | 100 | 28.7 | 11.2-112.3 | D-126 |
| Benzo(a)anthracene | 10 | 4.0 | 3.1-11.6 | 12-135 |
| Benzo(a)pyrene | 10 | 4.0 | 0.2-11.0 | D-128 |
| Benzo(b)fluor-anthene | 10 | 3.1 | 1.8-13.8 | 6-150 |
| Benzo(ghi)perylene | 10 | 2.3 | D-10.7 | D-116 |
| Benzo(k)fluor-anthene | 5 | 2.5 | D-7.0 | D-159 |
| Chrysene | 10 | 4.2 | D-17.5 | D-199 |
| Dibenzo(a,h)an-thracene | 10 | 2.0 | 0.3-10.0 | D-110 |
| Fluoranthene | 10 | 3.0 | 2.7-11.1 | 14-123 |
| Fluorene | 100 | 43.0 | D-119 | D-142 |
| Indeno(1,2,3-cd)pyrene | 10 | 3.0 | 1.2-10.0 | D-116 |
| Naphthalene | 100 | 40.7 | 21.5-100.0 | D-122 |
| Phenanthrene | 100 | 37.7 | 8.4-133.7 | D-155 |
| Pyrene | 10 | 3.4 | 1.4-12.1 | D-140 |

s=Standard deviation of four recovery measurements, in µg/L (Section 8.2.4).

X̄=Average recovery for four recovery measurements, in µg/L (Section 8.2.4).

P, P_s=Percent recovery measured (Section 8.3.2, Section 8.4.2).

D=Detected; result must be greater than zero.

NOTE: These criteria are based directly upon the method performance data in Table 4. Where necessary, the limits for recovery have been broadened to assure applicability of the limits to concentrations below those used to develop Table 4.

TABLE 4—METHOD ACCURACY AND PRECISION AS FUNCTIONS OF CONCENTRATION—METHOD 610

| Parameter | Accuracy, as recovery, X' ($\mu\text{g/L}$) | Single analyst precision, s_s' ($\mu\text{g/L}$) | Overall precision, S' ($\mu\text{g/L}$) |
|------------------------|---|--|---|
| Acenaphthene | $0.52C + 0.54$ | $0.39\bar{X} + 0.76$ | $0.53\bar{X} + 1.32$ |
| Acenaphthylene | $0.69C - 1.89$ | $0.36\bar{X} + 0.29$ | $0.42\bar{X} + 0.52$ |
| Anthracene | $0.63C - 1.26$ | $0.23\bar{X} + 1.16$ | $0.41\bar{X} + 0.45$ |
| Benzo(a)anthracene | $0.73C + 0.05$ | $0.28\bar{X} + 0.04$ | $0.34\bar{X} + 0.02$ |
| Benzo(a)pyrene | $0.56C + 0.01$ | $0.38\bar{X} - 0.01$ | $0.53\bar{X} - 0.01$ |
| Benzo(b)fluoranthene | $0.78C + 0.01$ | $0.21\bar{X} + 0.01$ | $0.38\bar{X} - 0.00$ |
| Benzo(ghi)perylene | $0.44C + 0.30$ | $0.25\bar{X} + 0.04$ | $0.58\bar{X} + 0.10$ |
| Benzo(k)fluoranthene | $0.59C + 0.00$ | $0.44\bar{X} - 0.00$ | $0.69\bar{X} + 0.01$ |
| Chrysene | $0.77C - 0.18$ | $0.32\bar{X} - 0.18$ | $0.66\bar{X} - 0.22$ |
| Dibenzo(a,h)anthracene | $0.41C + 0.11$ | $0.24\bar{X} + 0.02$ | $0.45\bar{X} + 0.03$ |
| Fluoranthene | $0.68C + 0.07$ | $0.22\bar{X} + 0.06$ | $0.32\bar{X} + 0.03$ |
| Fluorene | $0.56C - 0.52$ | $0.44\bar{X} - 1.12$ | $0.63\bar{X} - 0.65$ |
| Indeno(1,2,3-cd)pyrene | $0.54C + 0.06$ | $0.29\bar{X} + 0.02$ | $0.42\bar{X} + 0.01$ |
| Naphthalene | $0.57C - 0.70$ | $0.39\bar{X} - 0.18$ | $0.41\bar{X} + 0.74$ |
| Phenanthrene | $0.72C - 0.95$ | $0.29\bar{X} + 0.05$ | $0.47\bar{X} - 0.25$ |
| Pyrene | $0.69C - 0.12$ | $0.25\bar{X} + 0.14$ | $0.42\bar{X} - 0.00$ |

X' =Expected recovery for one or more measurements of a sample containing a concentration of C , in $\mu\text{g/L}$.
 s_s' =Expected single analyst standard deviation of measurements at an average concentration found of \bar{X} , in $\mu\text{g/L}$.
 S' =Expected interlaboratory standard deviation of measurements at an average concentration found of \bar{X} , in $\mu\text{g/L}$.
 C =True value for the concentration, in $\mu\text{g/L}$.
 \bar{X} =Average recovery found for measurements of samples containing a concentration of C , in $\mu\text{g/L}$.

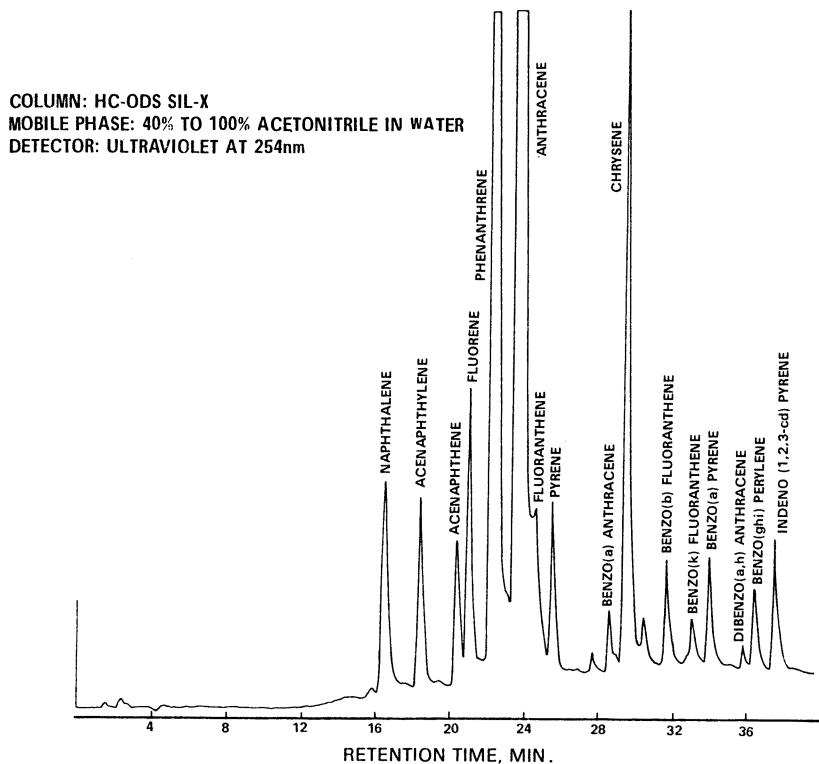

Figure 1. Liquid chromatogram of polynuclear aromatic hydrocarbons.

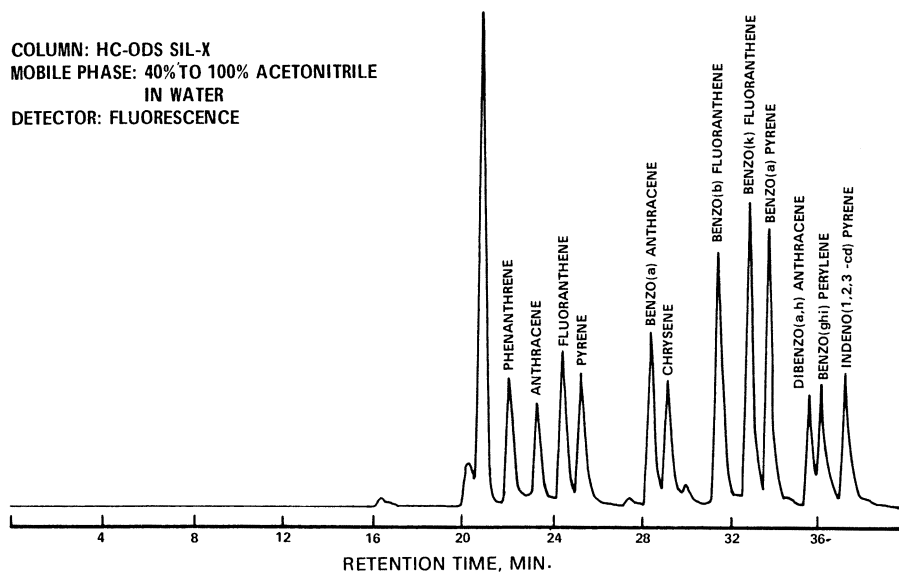

Figure 2. Liquid chromatogram of polynuclear aromatic hydrocarbons.

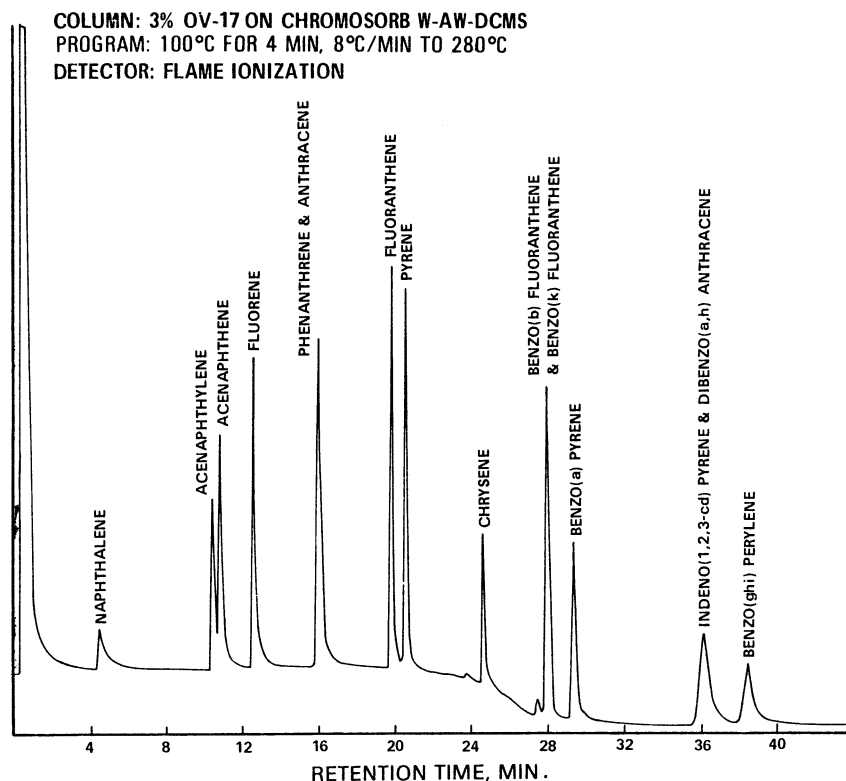

Figure 3. Gas chromatogram of polynuclear aromatic hydrocarbons.

METHOD 611—HALOETHERS

1. Scope and Application

1.1 This method covers the determination of certain haloethers. The following parameters can be determined by this method:

| Parameter | STORET No. | CAS No. |
|------------------------------------|------------|-----------|
| Bis(2-chloroethyl) ether | 34273 | 111-44-4 |
| Bis(2-chloroethoxy) methane | 34278 | 111-91-1 |
| Bis(2-chloroisopropyl) ether | 34283 | 108-60-1 |
| 4-Bromophenyl phenyl ether | 34636 | 101-55-3 |
| 4-Chlorophenyl phenyl ether | 34641 | 7005-72-3 |

1.2 This is a gas chromatographic (GC) method applicable to the determination of the compounds listed above in municipal and industrial discharges as provided under 40 CFR 136.1. When this method is used to analyze unfamiliar samples for any or all of the compounds above, compound identifications should be supported by at least one additional qualitative technique. This method describes analytical conditions for a second

gas chromatographic column that can be used to confirm measurements made with the primary column. Method 625 provides gas chromatograph/mass spectrometer (GC/MS) conditions appropriate for the qualitative and quantitative confirmation of results for all of the parameters listed above, using the extract produced by this method.

1.3 The method detection limit (MDL, defined in Section 14.1)¹ for each parameter is listed in Table 1. The MDL for a specific wastewater may differ from those listed, depending upon the nature of interferences in the sample matrix.

1.4 The sample extraction and concentration steps in this method are essentially the same as in Methods 606, 608, 609, and 612. Thus, a single sample may be extracted to measure the parameters included in the scope of each of these methods. When cleanup is required, the concentration levels must be high enough to permit selecting aliquots, as necessary, to apply appropriate cleanup procedures. The analyst is allowed the latitude, under Section 12, to select

chromatographic conditions appropriate for the simultaneous measurement of combinations of these parameters.

1.5 Any modification of this method, beyond those expressly permitted, shall be considered as a major modification subject to application and approval of alternate test procedures under 40 CFR 136.4 and 136.5.

1.6 This method is restricted to use by or under the supervision of analysts experienced in the use of a gas chromatograph and in the interpretation of gas chromatograms. Each analyst must demonstrate the ability to generate acceptable results with this method using the procedure described in Section 8.2.

2. Summary of Method

2.1 A measured volume of sample, approximately 1-L, is extracted with methylene chloride using a separatory funnel. The methylene chloride extract is dried and exchanged to hexane during concentration to a volume of 10 mL or less. The extract is separated by gas chromatography and the parameters are then measured with a halide specific detector.²

2.2 The method provides a Florisil column cleanup procedure to aid in the elimination of interferences that may be encountered.

3. Interferences

3.1 Method interferences may be caused by contaminants in solvents, reagents, glassware, and other sample processing hardware that lead to discrete artifacts and/or elevated baselines in gas chromatograms. All of these materials must be routinely demonstrated to be free from interferences under the conditions of the analysis by running laboratory reagent blanks as described in Section 8.1.3.

3.1.1 Glassware must be scrupulously cleaned.³ Clean all glassware as soon as possible after use by rinsing with the last solvent used in it. Solvent rinsing should be followed by detergent washing with hot water, and rinses with tap water and distilled water. The glassware should then be drained dry, and heated in a muffle furnace at 400 °C for 15 to 30 min. Some thermally stable materials, such as PCBs, may not be eliminated by this treatment. Solvent rinses with acetone and pesticide quality hexane may be substituted for the muffle furnace heating. Thorough rinsing with such solvents usually eliminates PCB interference. Volumetric ware should not be heated in a muffle furnace. After drying and cooling, glassware should be sealed and stored in a clean environment to prevent any accumulation of dust or other contaminants. Store inverted or capped with aluminum foil.

3.1.2 The use of high purity reagents and solvents helps to minimize interference prob-

lems. Purification of solvents by distillation in all-glass systems may be required.

3.2 Matrix interferences may be caused by contaminants that are co-extracted from the sample. The extent of matrix interferences will vary considerably from source to source, depending upon the nature and diversity of the industrial complex or municipality being sampled. The cleanup procedure in Section 11 can be used to overcome many of these interferences, but unique samples may require additional cleanup approaches to achieve the MDL listed in Table 1.

3.3 Dichlorobenzenes are known to coelute with haloethers under some gas chromatographic conditions. If these materials are present together in a sample, it may be necessary to analyze the extract with two different column packings to completely resolve all of the compounds.

4. Safety

4.1 The toxicity or carcinogenicity of each reagent used in this method has not been precisely defined; however, each chemical compound should be treated as a potential health hazard. From this viewpoint, exposure to these chemicals must be reduced to the lowest possible level by whatever means available. The laboratory is responsible for maintaining a current awareness file of OSHA regulations regarding the safe handling of the chemicals specified in this method. A reference file of material data handling sheets should also be made available to all personnel involved in the chemical analysis. Additional references to laboratory safety are available and have been identified^{4,6} for the information of the analyst.

5. Apparatus and Materials

5.1 Sampling equipment, for discrete or composite sampling.

5.1.1 Grab sample bottle—1-L or 1-qt, amber glass, fitted with a screw cap lined with Teflon. Foil may be substituted for Teflon if the sample is not corrosive. If amber bottles are not available, protect samples from light. The bottle and cap liner must be washed, rinsed with acetone or methylene chloride, and dried before use to minimize contamination.

5.1.2 Automatic sampler (optional)—The sampler must incorporate glass sample containers for the collection of a minimum of 250 mL of sample. Sample containers must be kept refrigerated at 4 °C and protected from light during compositing. If the sampler uses a peristaltic pump, a minimum length of compressible silicone rubber tubing may be used. Before use, however, the compressible tubing should be thoroughly rinsed with methanol, followed by repeated rinsings with distilled water to minimize the potential for contamination of the sample. An integrating

flow meter is required to collect flow proportional composites.

5.2 Glassware (All specifications are suggested. Catalog numbers are included for illustration only.):

5.2.1 Separatory funnel—2-L, with Teflon stopcock.

5.2.2 Drying column—Chromatographic column, approximately 400 mm long × 19 mm ID, with coarse frit filter disc.

5.2.3 Chromatographic column—400 mm long × 19 mm ID, with Teflon stopcock and coarse frit filter disc at bottom (Kontes K-420540-0224 or equivalent).

5.2.4 Concentrator tube, Kuderna-Danish—10-mL, graduated (Kontes K-570050-1025 or equivalent). Calibration must be checked at the volumes employed in the test. Ground glass stopper is used to prevent evaporation of extracts.

5.2.5 Evaporative flask, Kuderna-Danish—500-mL (Kontes K-570001-0500 or equivalent). Attach to concentrator tube with springs.

5.2.6 Snyder column, Kuderna-Danish—Three-ball macro (Kontes K-503000-0121 or equivalent).

5.2.7 Vials—10 to 15-mL, amber glass, with Teflon-lined screw cap.

5.3 Boiling chips—Approximately 10/40 mesh. Heat to 400 °C for 30 min or Soxhlet extract with methylene chloride.

5.4 Water bath—Heated, with concentric ring cover, capable of temperature control ($\pm 2^\circ\text{C}$). The bath should be used in a hood.

5.5 Balance—Analytical, capable of accurately weighing 0.0001 g.

5.6 Gas chromatograph—An analytical system complete with temperature programmable gas chromatograph suitable for on-column injection and all required accessories including syringes, analytical columns, gases, detector, and strip-chart recorder. A data system is recommended for measuring peak areas.

5.6.1 Column 1—1.8 m long × 2 mm ID glass, packed with 3% SP-1000 on Supelcoport (100/120 mesh) or equivalent. This column was used to develop the method performance statements in Section 14. Guidelines for the use of alternate column packings are provided in Section 12.1.

5.6.2 Column 2—1.8 m long × 2 mm ID glass, packed with 2,6-diphenylene oxide polymer (60/80 mesh), Tenax, or equivalent.

5.6.3 Detector—Halide specific detector: electrolytic conductivity or microcoulometric. These detectors have proven effective in the analysis of wastewaters for the parameters listed in the scope (Section 1.1). The Hall conductivity detector was used to develop the method performance statements in Section 14. Guidelines for the use of alternate detectors are provided in Section 12.1. Although less selective, an electron capture detector is an acceptable alternative.

6. Reagents

6.1 Reagent water—Reagent water is defined as a water in which an interferent is not observed at the MDL of the parameters of interest.

6.2 Sodium thiosulfate—(ACS) Granular.

6.3 Acetone, hexane, methanol, methylene chloride, petroleum ether (boiling range 30–60 °C)—Pesticide quality or equivalent.

6.4 Sodium sulfate—(ACS) Granular, anhydrous. Purify by heating at 400 °C for 4 h in a shallow tray.

6.5 Florisil—PR Grade (60/100 mesh). Purchase activated at 1250 °F and store in the dark in glass containers with ground glass stoppers or foil-lined screw caps. Before use, activate each batch at least 16 h at 130 °C in a foil-covered glass container and allow to cool.

6.6 Ethyl ether—Nanograde, redistilled in glass if necessary.

6.6.1 Ethyl ether must be shown to be free of peroxides before it is used as indicated by EM Laboratories Quant test strips. (Available from Scientific Products Co., Cat. No. P1126-8, and other suppliers.)

6.6.2 Procedures recommended for removal of peroxides are provided with the test strips. After cleanup, 20 mL of ethyl alcohol preservative must be added to each liter of ether.

6.7 Stock standard solutions (1.00 µg/µL)—Stock standard solutions can be prepared from pure standard materials or purchased as certified solutions.

6.7.1 Prepare stock standard solutions by accurately weighing about 0.0100 g of pure material. Dissolve the material in acetone and dilute to volume in a 10-mL volumetric flask. Larger volumes can be used at the convenience of the analyst. When compound purity is assayed to be 96% or greater, the weight can be used without correction to calculate the concentration of the stock standard. Commercially prepared stock standards can be used at any concentration if they are certified by the manufacturer or by an independent source.

6.7.2 Transfer the stock standard solutions into Teflon-sealed screw-cap bottles. Store at 4 °C and protect from light. Stock standard solutions should be checked frequently for signs of degradation or evaporation, especially just prior to preparing calibration standards from them.

6.7.3 Stock standard solutions must be replaced after six months, or sooner if comparison with check standards indicates a problem.

6.8 Quality control check sample concentrate—See Section 8.2.1.

7. Calibration

7.1 Establish gas chromatographic operating conditions equivalent to those given in Table 1. The gas chromatographic system

can be calibrated using the external standard technique (Section 7.2) or the internal standard technique (Section 7.3).

7.2 External standard calibration procedure:

7.2.1 Prepare calibration standards at a minimum of three concentration levels for each parameter of interest by adding volumes of one or more stock standards to a volumetric flask and diluting to volume with hexane. One of the external standards should be at a concentration near, but above, the MDL (Table 1) and the other concentrations should correspond to the expected range of concentrations found in real samples or should define the working range of the detector.

7.2.2 Using injections of 2 to 5 μL , analyze each calibration standard according to Section 12 and tabulate peak height or area responses against the mass injected. The results can be used to prepare a calibration curve for each compound. Alternatively, if the ratio of response to amount injected (calibration factor) is a constant over the working range (<10% relative standard deviation, RSD), linearity through the origin can be assumed and the average ratio or calibration factor can be used in place of a calibration curve.

7.3 Internal standard calibration procedure—To use this approach, the analyst must select one or more internal standards that are similar in analytical behavior to the compounds of interest. The analyst must further demonstrate that the measurement of the internal standard is not affected by method or matrix interferences. Because of these limitations, no internal standard can be suggested that is applicable to all samples.

7.3.1 Prepare calibration standards at a minimum of three concentration levels for each parameter of interest by adding volumes of one or more stock standards to a volumetric flask. To each calibration standard, add a known constant amount of one or more internal standards, and dilute to volume with hexane. One of the standards should be at a concentration near, but above, the MDL and the other concentrations should correspond to the expected range of concentrations found in real samples or should define the working range of the detector.

7.3.2 Using injections of 2 to 5 μL , analyze each calibration standard according to Section 12 and tabulate peak height or area responses against concentration for each compound and internal standard. Calculate response factors (RF) for each compound using Equation 1.

$$\text{RF} = \frac{(A_s)(C_{is})}{(A_{is})(C_s)}$$

Equation 1

where:

A_s =Response for the parameter to be measured.

A_{is} =Response for the internal standard.

C_{is} =Concentration of the internal standard ($\mu\text{g/L}$).

C_s =Concentration of the parameter to be measured ($\mu\text{g/L}$).

If the RF value over the working range is a constant (<10% RSD), the RF can be assumed to be invariant and the average RF can be used for calculations. Alternatively, the results can be used to plot a calibration curve of response ratios, A_s/A_{is} , vs. RF.

7.4 The working calibration curve, calibration factor, or RF must be verified on each working day by the measurement of one or more calibration standards. If the response for any parameter varies from the predicted response by more than $\pm 15\%$, a new calibration curve must be prepared for that compound.

7.5 The cleanup procedure in Section 11 utilizes Florisil column chromatography. Florisil from different batches or sources may vary in adsorptive capacity. To standardize the amount of Florisil which is used, the use of lauric acid value⁷ is suggested. The referenced procedure determines the adsorption from hexane solution of lauric acid (mg) per g of Florisil. The amount of Florisil to be used for each column is calculated by dividing 110 by this ratio and multiplying by 20 g.

7.6 Before using any cleanup procedure, the analyst must process a series of calibration standards through the procedure to validate elution patterns and the absence of interferences from the reagents.

8. Quality Control

8.1 Each laboratory that uses this method is required to operate a formal quality control program. The minimum requirements of this program consist of an initial demonstration of laboratory capability and an ongoing analysis of spiked samples to evaluate and document data quality. The laboratory must maintain records to document the quality of data that is generated. Ongoing data quality checks are compared with established performance criteria to determine if the results of analyses meet the performance characteristics of the method. When results of sample spikes indicate atypical method performance, a quality control check standard must be analyzed to confirm that the measurements were performed in an in-control mode of operation.

8.1.1 The analyst must make an initial, one-time, demonstration of the ability to generate acceptable accuracy and precision with this method. This ability is established as described in Section 8.2.

8.1.2 In recognition of advances that are occurring in chromatography, the analyst is permitted certain options (detailed in Sections 10.4, 11.1, and 12.1) to improve the separations or lower the cost of measurements. Each time such a modification is made to the method, the analyst is required to repeat the procedure in Section 8.2.

8.1.3 Before processing any samples, the analyst must analyze a reagent water blank to demonstrate that interferences from the analytical system and glassware are under control. Each time a set of samples is extracted or reagents are changed, a reagent water blank must be processed as a safeguard against laboratory contamination.

8.1.4 The laboratory must, on an ongoing basis, spike and analyze a minimum of 10% of all samples to monitor and evaluate laboratory data quality. This procedure is described in Section 8.3.

8.1.5 The laboratory must, on an ongoing basis, demonstrate through the analyses of quality control check standards that the operation of the measurement system is in control. This procedure is described in Section 8.4. The frequency of the check standard analyses is equivalent to 10% of all samples analyzed but may be reduced if spike recoveries from samples (Section 8.3) meet all specified quality control criteria.

8.1.6 The laboratory must maintain performance records to document the quality of data that is generated. This procedure is described in Section 8.5.

8.2 To establish the ability to generate acceptable accuracy and precision, the analyst must perform the following operations.

8.2.1 A quality control (QC) check sample concentrate is required containing each parameter of interest at a concentration of 100 µg/mL in acetone. The QC check sample concentrate must be obtained from the U.S. Environmental Protection Agency, Environmental Monitoring and Support Laboratory in Cincinnati, Ohio, if available. If not available from that source, the QC check sample concentrate must be obtained from another external source. If not available from either source above, the QC check sample concentrate must be prepared by the laboratory using stock standards prepared independently from those used for calibration.

8.2.2 Using a pipet, prepare QC check samples at a concentration of 100 µg/L by adding 1.00 mL of QC check sample concentrate to each of four 1-L aliquots of reagent water.

8.2.3 Analyze the well-mixed QC check samples according to the method beginning in Section 10.

8.2.4 Calculate the average recovery (\bar{X}) in µg/L, and the standard deviation of the recovery (s) in µg/L, for each parameter using the four results.

8.2.5 For each parameter compare s and \bar{X} with the corresponding acceptance criteria for precision and accuracy, respectively,

found in Table 2. If s and \bar{X} for all parameters of interest meet the acceptance criteria, the system performance is acceptable and analysis of actual samples can begin. If any individual s exceeds the precision limit or any individual \bar{X} falls outside the range for accuracy, the system performance is unacceptable for that parameter. Locate and correct the source of the problem and repeat the test for all parameters of interest beginning with Section 8.2.2.

8.3 The laboratory must, on an ongoing basis, spike at least 10% of the samples from each sample site being monitored to assess accuracy. For laboratories analyzing one to ten samples per month, at least one spiked sample per month is required.

8.3.1 The concentration of the spike in the sample should be determined as follows:

8.3.1.1 If, as in compliance monitoring, the concentration of a specific parameter in the sample is being checked against a regulatory concentration limit, the spike should be at that limit or 1 to 5 times higher than the background concentration determined in Section 8.3.2, whichever concentration would be larger.

8.3.1.2 If the concentration of a specific parameter in the sample is not being checked against a limit specific to that parameter, the spike should be at 100 µg/L or 1 to 5 times higher than the background concentration determined in Section 8.3.2, whichever concentration would be larger.

8.3.1.3 If it is impractical to determine background levels before spiking (e.g., maximum holding times will be exceeded), the spike concentration should be (1) the regulatory concentration limit, if any; or, if none (2) the larger of either 5 times higher than the expected background concentration or 100 µg/L.

8.3.2 Analyze one sample aliquot to determine the background concentration (B) of each parameter. If necessary, prepare a new QC check sample concentrate (Section 8.2.1) appropriate for the background concentrations in the sample. Spike a second sample aliquot with 1.0 mL of the QC check sample concentrate and analyze it to determine the concentration after spiking (A) of each parameter. Calculate each percent recovery (P) as $100(A - B)/T$, where T is the known true value of the spike.

8.3.3 Compare the percent recovery (P) for each parameter with the corresponding QC acceptance criteria found in Table 2. These acceptance criteria were calculated to include an allowance for error in measurement of both the background and spike concentrations, assuming a spike to background ratio of 5:1. This error will be accounted for to the extent that the analyst's spike to background ratio approaches 5:1.⁸ If spiking was performed at a concentration lower than 100 µg/L, the analyst must use either the QC acceptance criteria in Table 2, or optional QC

acceptance criteria calculated for the specific spike concentration. To calculate optional acceptance criteria for the recovery of a parameter: (1) Calculate accuracy (X') using the equation in Table 3, substituting the spike concentration (T) for C ; (2) calculate overall precision (S') using the equation in Table 3, substituting X' for \bar{X} ; (3) calculate the range for recovery at the spike concentration as $(100 X'/T) \pm 2.44(100 S'/T)\%$.⁸

8.3.4 If any individual P falls outside the designated range for recovery, that parameter has failed the acceptance criteria. A check standard containing each parameter that failed the criteria must be analyzed as described in Section 8.4.

8.4 If any parameter fails the acceptance criteria for recovery in Section 8.3, a QC check standard containing each parameter that failed must be prepared and analyzed.

NOTE: The frequency for the required analysis of a QC check standard will depend upon the number of parameters being simultaneously tested, the complexity of the sample matrix, and the performance of the laboratory.

8.4.1 Prepare the QC check standard by adding 1.0 mL of QC check sample concentrate (Section 8.2.1 or 8.3.2) to 1 L of reagent water. The QC check standard needs only to contain the parameters that failed criteria in the test in Section 8.3.

8.4.2 Analyze the QC check standard to determine the concentration measured (A) of each parameter. Calculate each percent recovery (P_s) as $100 (A/T)\%$, where T is the true value of the standard concentration.

8.4.3 Compare the percent recovery (P_s) for each parameter with the corresponding QC acceptance criteria found in Table 2. Only parameters that failed the test in Section 8.3 need to be compared with these criteria. If the recovery of any such parameter falls outside the designated range, the laboratory performance for that parameter is judged to be out of control, and the problem must be immediately identified and corrected. The analytical result for that parameter in the unspiked sample is suspect and may not be reported for regulatory compliance purposes.

8.5 As part of the QC program for the laboratory, method accuracy for wastewater samples must be assessed and records must be maintained. After the analysis of five spiked wastewater samples as in Section 8.3, calculate the average percent recovery (\bar{P}) and the standard deviation of the percent recovery (s_p). Express the accuracy assessment as a percent recovery interval from $\bar{P}-2s_p$ to $\bar{P}+2s_p$. If $\bar{P}=90\%$ and $s_p=10\%$, for example, the accuracy interval is expressed as 70–110%. Update the accuracy assessment for each parameter on a regular basis (e.g. after each five to ten new accuracy measurements).

8.6 It is recommended that the laboratory adopt additional quality assurance practices for use with this method. The specific prac-

tices that are most productive depend upon the needs of the laboratory and the nature of the samples. Field duplicates may be analyzed to assess the precision of the environmental measurements. When doubt exists over the identification of a peak on the chromatogram, confirmatory techniques such as gas chromatography with a dissimilar column, specific element detector, or mass spectrometer must be used. Whenever possible, the laboratory should analyze standard reference materials and participate in relevant performance evaluation studies.

9. Sample Collection, Preservation, and Handling

9.1 Grab samples must be collected in glass containers. Conventional sampling practices⁹ should be followed, except that the bottle must not be prerinsed with sample before collection. Composite samples should be collected in refrigerated glass containers in accordance with the requirements of the program. Automatic sampling equipment must be as free as possible of Tygon tubing and other potential sources of contamination.

9.2 All samples must be iced or refrigerated at 4 °C from the time of collection until extraction. Fill the sample bottles and, if residual chlorine is present, add 80 mg of sodium thiosulfate per liter of sample and mix well. EPA Methods 330.4 and 330.5 may be used for measurement of residual chlorine.¹⁰ Field test kits are available for this purpose.

9.3 All samples must be extracted within 7 days of collection and completely analyzed within 40 days of extraction.²

10. Sample Extraction

10.1 Mark the water meniscus on the side of the sample bottle for later determination of sample volume. Pour the entire sample into a 2-L separatory funnel.

10.2 Add 60 mL methylene chloride to the sample bottle, seal, and shake 30 s to rinse the inner surface. Transfer the solvent to the separatory funnel and extract the sample by shaking the funnel for 2 min with periodic venting to release excess pressure. Allow the organic layer to separate from the water phase for a minimum of 10 min. If the emulsion interface between layers is more than one-third the volume of the solvent layer, the analyst must employ mechanical techniques to complete the phase separation. The optimum technique depends upon the sample, but may include stirring, filtration of the emulsion through glass wool, centrifugation, or other physical methods. Collect the methylene chloride extract in a 250-mL Erlenmeyer flask.

10.3 Add a second 60-mL volume of methylene chloride to the sample bottle and repeat the extraction procedure a second time,

combining the extracts in the Erlenmeyer flask. Perform a third extraction in the same manner.

10.4 Assemble a Kuderna-Danish (K-D) concentrator by attaching a 10-mL concentrator tube to a 500-mL evaporative flask. Other concentration devices or techniques may be used in place of the K-D concentrator if the requirements of Section 8.2 are met.

10.5 Pour the combined extract through a solvent-rinsed drying column containing about 10 cm of anhydrous sodium sulfate, and collect the extract in the K-D concentrator. Rinse the Erlenmeyer flask and column with 20 to 30 mL of methylene chloride to complete the quantitative transfer.

10.6 Add one or two clean boiling chips to the evaporative flask and attach a three-ball Snyder column. Prewet the Snyder column by adding about 1 mL of methylene chloride to the top. Place the K-D apparatus on a hot water bath (60 to 65 °C) so that the concentrator tube is partially immersed in the hot water, and the entire lower rounded surface of the flask is bathed with hot vapor. Adjust the vertical position of the apparatus and the water temperature as required to complete the concentration in 15 to 20 min. At the proper rate of distillation the balls of the column will actively chatter but the chambers will not flood with condensed solvent. When the apparent volume of liquid reaches 1 mL, remove the K-D apparatus and allow it to drain and cool for at least 10 min.

NOTE: Some of the haloethers are very volatile and significant losses will occur in concentration steps if care is not exercised. It is important to maintain a constant gentle evaporation rate and not to allow the liquid volume to fall below 1 to 2 mL before removing the K-D apparatus from the hot water bath.

10.7 Momentarily remove the Snyder column, add 50 mL of hexane and a new boiling chip, and reattach the Snyder column. Raise the temperature of the water bath to 85 to 90 °C. Concentrate the extract as in Section 10.6, except use hexane to prewet the column. The elapsed time of concentration should be 5 to 10 min.

10.8 Remove the Snyder column and rinse the flask and its lower joint into the concentrator tube with 1 to 2 mL of hexane. A 5-mL syringe is recommended for this operation. Stopper the concentrator tube and store refrigerated if further processing will not be performed immediately. If the extract will be stored longer than two days, it should be transferred to a Teflon-sealed screw-cap vial. If the sample extract requires no further cleanup, proceed with gas chromatographic analysis (Section 12). If the sample requires further cleanup, proceed to Section 11.

10.9 Determine the original sample volume by refilling the sample bottle to the mark and transferring the liquid to a 1000-

mL graduated cylinder. Record the sample volume to the nearest 5 mL.

11. Cleanup and Separation

11.1 Cleanup procedures may not be necessary for a relatively clean sample matrix. If particular circumstances demand the use of a cleanup procedure, the analyst may use the procedure below or any other appropriate procedure. However, the analyst first must demonstrate that the requirements of Section 8.2 can be met using the method as revised to incorporate the cleanup procedure.

11.2 Florisil column cleanup for haloethers:

11.2.1 Adjust the sample extract volume to 10 mL.

11.2.2 Place a weight of Florisil (nominally 20 g) predetermined by calibration (Section 7.5), into a chromatographic column. Tap the column to settle the Florisil and add 1 to 2 cm of anhydrous sodium sulfate to the top.

11.2.3 Preelute the column with 50 to 60 mL of petroleum ether. Discard the eluate and just prior to exposure of the sodium sulfate layer to the air, quantitatively transfer the sample extract onto the column by decantation and subsequent petroleum ether washings. Discard the eluate. Just prior to exposure of the sodium sulfate layer to the air, begin eluting the column with 300 mL of ethyl ether/petroleum ether (6+94) (V/V). Adjust the elution rate to approximately 5 mL/min and collect the eluate in a 500-mL K-D flask equipped with a 10-mL concentrator tube. This fraction should contain all of the haloethers.

11.2.4 Concentrate the fraction as in Section 10.6, except use hexane to prewet the column. When the apparatus is cool, remove the Snyder column and rinse the flask and its lower joint into the concentrator tube with hexane. Adjust the volume of the cleaned up extract to 10 mL with hexane and analyze by gas chromatography (Section 12).

12. Gas Chromatography

12.1 Table 1 summarizes the recommended operating conditions for the gas chromatograph. Included in this table are retention times and MDL that can be achieved under these conditions. Examples of the separations achieved by Columns 1 and 2 are shown in Figures 1 and 2, respectively. Other packed or capillary (open-tubular) columns, chromatographic conditions, or detectors may be used if the requirements of Section 8.2 are met.

12.2 Calibrate the system daily as described in Section 7.

12.3 If the internal standard calibration procedure is being used, the internal standard must be added to the sample extract and mixed thoroughly immediately before injection into the gas chromatograph.

12.4 Inject 2 to 5 μL of the sample extract or standard into the gas chromatograph using the solvent-flush technique.¹¹ Smaller (1.0 μL) volumes may be injected if automatic devices are employed. Record the volume injected to the nearest 0.05 μL , the total extract volume, and the resulting peak size in area or peak height units.

12.5 Identify the parameters in the sample by comparing the retention times of the peaks in the sample chromatogram with those of the peaks in standard chromatograms. The width of the retention time window used to make identifications should be based upon measurements of actual retention time variations of standards over the course of a day. Three times the standard deviation of a retention time for a compound can be used to calculate a suggested window size; however, the experience of the analyst should weight heavily in the interpretation of chromatograms.

12.6 If the response for a peak exceeds the working range of the system, dilute the extract and reanalyze.

12.7 If the measurement of the peak response is prevented by the presence of interferences, further cleanup is required.

13. Calculations

13.1 Determine the concentration of individual compounds in the sample.

13.1.1 If the external standard calibration procedure is used, calculate the amount of material injected from the peak response using the calibration curve or calibration factor determined in Section 7.2.2. The concentration in the sample can be calculated from Equation 2.

$$\text{Concentration } (\mu\text{g/L}) = \frac{(A)(V_t)}{(V_i)(V_s)}$$

Equation 2

where:

A=Amount of material injected (ng).

V_i =Volume of extract injected (μL).

V_t =Volume of total extract (μL).

V_s =Volume of water extracted (mL).

13.1.2 If the internal standard calibration procedure is used, calculate the concentration in the sample using the response factor (RF) determined in Section 7.3.2 and Equation 3.

$$\text{Concentration } (\mu\text{g/L}) = \frac{(A_s)(I_s)}{(A_{is})(\text{RF})(V_o)}$$

Equation 3

where:

A_s =Response for the parameter to be measured.

A_{is} =Response for the internal standard.

I_s =Amount of internal standard added to each extract (μg).

V_o =Volume of water extracted (L).

13.2 Report results in $\mu\text{g/L}$ without correction for recovery data. All QC data obtained should be reported with the sample results.

14. Method Performance

14.1 The method detection limit (MDL) is defined as the minimum concentration of a substance that can be measured and reported with 99% confidence that the value is above zero.¹ The MDL concentrations listed in Table 1 were obtained using reagent water.¹² Similar results were achieved using representative wastewaters. The MDL actually achieved in a given analysis will vary depending on instrument sensitivity and matrix effects.

14.2 This method has been tested for linearity of spike recovery from reagent water and has been demonstrated to be applicable over the concentration range from $4 \times \text{MDL}$ to $1000 \times \text{MDL}$.¹²

14.3 This method was tested by 20 laboratories using reagent water, drinking water, surface water, and three industrial wastewaters spiked at six concentrations over the range 1.0 to 626 μL .¹² Single operator precision, overall precision, and method accuracy were found to be directly related to the concentration of the parameter and essentially independent of the sample matrix. Linear equations to describe these relationships are presented in Table 3.

REFERENCES

- 40 CFR part 136, appendix B.
- "Determination of Haloethers in Industrial and Municipal Wastewaters," EPA 600/4-81-062, National Technical Information Service, PB81-232290, Springfield, Virginia 22161, July 1981.
- ASTM Annual Book of Standards, Part 31, D3694-78. "Standard Practices for Preparation of Sample Containers and for Preservation of Organic Constituents," American Society for Testing and Materials, Philadelphia.
- "Carcinogens—Working Carcinogens," Department of Health, Education, and Welfare, Public Health Services, Center for Disease Control, National Institute for Occupational Safety and Health, Publication No. 77-206, August 1977.
- "OSHA Safety and Health Standards, General Industry," (29 CFR part 1910), Occupational Safety and Health Administration, OSHA 2206 (Revised, January 1976).
- "Safety in Academic Chemistry Laboratories," American Chemical Society Publication, Committee on Chemical Safety, 3rd Edition, 1979.
- Mills., P.A. "Variation of Florisil Activity: Simple Method for Measuring Absorbent Capacity and Its Use in Standardizing

Florisil Columns," *Journal of the Association of Official Analytical Chemists*, 51, 29 (1968).

8. Provost, L.P., and Elder, R.S. "Interpretation of Percent Recovery Data," *American Laboratory*, 15, 58-63 (1983). (The value 2.44 used in the equation in Section 8.3.3 is two times the value 1.22 derived in this report.)

9. ASTM Annual Book of Standards, Part 31, D3370-76. "Standard Practices for Sampling Water," American Society for Testing and Materials, Philadelphia.

10. "Methods 330.4 (Titrimetric, DPD-FAS) and 330.5 (Spectrophotometric, DPD) for Chlorine, Total Residual," Methods for

Chemical Analysis of Water and Wastes, EPA-600/4-79-020, U.S. Environmental Protection Agency, Environmental Monitoring and Support Laboratory, Cincinnati, Ohio 45268, March 1979.

11. Burke, J.A. "Gas Chromatography for Pesticide Residue Analysis; Some Practical Aspects," *Journal of the Association of Official Analytical Chemists*, 48, 1037 (1965).

12. "EPA Method Study 21, Method 611, Haloethers," EPA 600/4-84-052, National Technical Information Service, PB84-205939, Springfield, Virginia 22161, June 1984.

TABLE 1—CHROMATOGRAPHIC CONDITIONS AND METHODS DETECTION LIMITS

| Parameters | Retention time (min) | | Method detection limit (µ/L) |
|------------------------------------|----------------------|----------|------------------------------|
| | Column 1 | Column 2 | |
| Bis(2-chloroisopropyl) ether | 8.4 | 9.7 | 0.8 |
| Bis(2-chloroethyl) ether | 9.3 | 9.1 | 0.3 |
| Bis(2-chloroethoxy) methane | 13.1 | 10.0 | 0.5 |
| 4-Chlorophenyl ether | 19.4 | 15.0 | 3.9 |
| 4-Bromophenyl phenyl ether | 21.2 | 16.2 | 2.3 |

Acolumn 1 conditions: Supelcoport (100/120 mesh) coated with 3% SP-1000 packed in a 1.8 m long × 2 mm ID glass column with helium carrier gas at 40 mL/min. flow rate. Column temperature held at 60 °C for 2 min. after injection then programmed at 8 °C/min. to 230 °C and held for 4 min. Under these conditions the retention time for Aldrin is 22.6 min.

Acolumn 2 conditions: Tenax-GC (60/80 mesh) packed in a 1.8 m long × 2mm ID glass column with helium carrier gas at 40 mL/min. flow rate. Column temperature held at 150 °C for 4 min. after injection then programmed at 16 °C/min. to 310 °C. Under these conditions the retention time for Aldrin is 18.4 min.

TABLE 2—QC ACCEPTANCE CRITERIA—METHOD 611

| Parameter | Test conc. (µg/L) | Limit for s (µg/L) | Range for \bar{X} (µg/L) | Range for P, P _c percent |
|------------------------------------|-------------------|--------------------|----------------------------|-------------------------------------|
| Bis (2-chloroethyl)ether | 100 | 26.3 | 26.3-136.8 | 11-152 |
| Bis (2-chloroethoxy)methane | 100 | 25.7 | 27.3-115.0 | 12-128 |
| Bis (2-chloroisopropyl)ether | 100 | 32.7 | 26.4-147.0 | 9-165 |
| 4-Bromophenyl phenyl ether | 100 | 39.3 | 7.6 -167.5 | D-189 |
| 4-Chlorophenyl phenyl ether | 100 | 30.7 | 15.4-152.5 | D-170 |

s=Standard deviation of four recovery measurements, in µg/L (Section 8.2.4).

\bar{X} =Average recovery for four recovery measurements, in µg/L (Section 8.2.4).

P, P_c=Percent recovery measured (Section 8.3.2, Section 8.4.2).

D=Detected; result must be greater than zero.

NOTE: These criteria are based directly upon the method performance data in Table 3. Where necessary, the limits for recovery have been broadened to assure applicability of the limits to concentrations below those used to develop Table 3.

TABLE 3—METHOD ACCURACY AND PRECISION AS FUNCTIONS OF CONCENTRATION—METHOD 611

| Parameter | Accuracy, as recovery, X' (µg/L) | Single analyst precision, s _r ' (µg/L) | Overall precision, S' (µg/L) |
|------------------------------------|----------------------------------|---|------------------------------|
| Bis(2-chloroethyl) ether | 0.81C+0.54 | 0.19 \bar{X} +0.28 | 0.35 \bar{X} +0.36 |
| Bis(2-chloroethoxy) methane | 0.71C+0.13 | 0.20 \bar{X} +0.15 | 0.33 \bar{X} +0.11 |
| Bis(2-chloroisopropyl) ether | 0.85C+1.67 | 0.20 \bar{X} +1.05 | 0.36 \bar{X} +0.79 |
| 4-Bromophenyl phenyl ether | 0.85C+2.55 | 0.25 \bar{X} +0.21 | 0.47 \bar{X} +0.37 |
| 4-Chlorophenyl phenyl ether | 0.82C+1.97 | 0.18 \bar{X} +2.13 | 0.41 \bar{X} +0.55 |

X' = Expected recovery for one or more measurements of a sample containing a concentration of C, in µg/L.

s_r' = Expected single analyst standard deviation of measurements at an average concentration found of \bar{X} , in µg/L.

S' = Expected interlaboratory standard deviation of measurements at an average concentration found of \bar{X} , in µg/L.

C = True value for the concentration, in µg/L.

\bar{X} = Average recovery found for measurements of samples containing a concentration of C, in µg/L.

COLUMN: 3% SP-1000 ON SUPELCOPORT
PROGRAM 60°C FOR 2 MIN, 8°C/MIN TO 230°C
DETECTOR: HALL ELECTROLYTIC CONDUCTIVITY

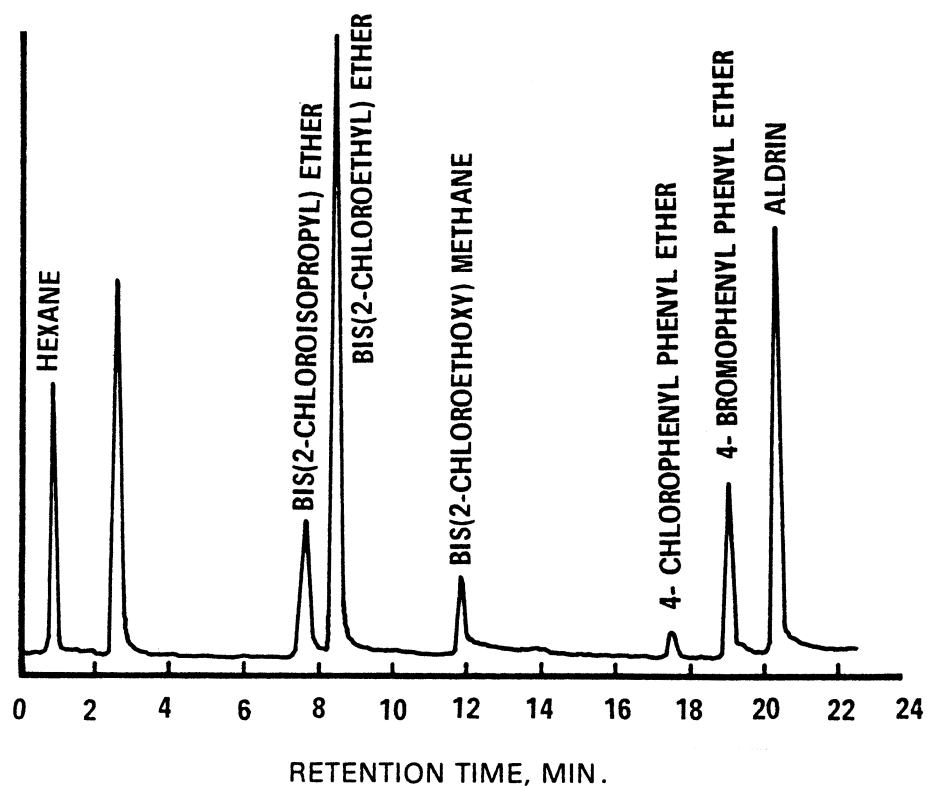

Figure 1. Gas chromatogram of haloethers.

COLUMN: TENAX GC
 PROGRAM: 150°C FOR 4 MIN, 16°C/MIN TO 310°C
 DETECTOR: HALL ELECTROLYTIC CONDUCTIVITY

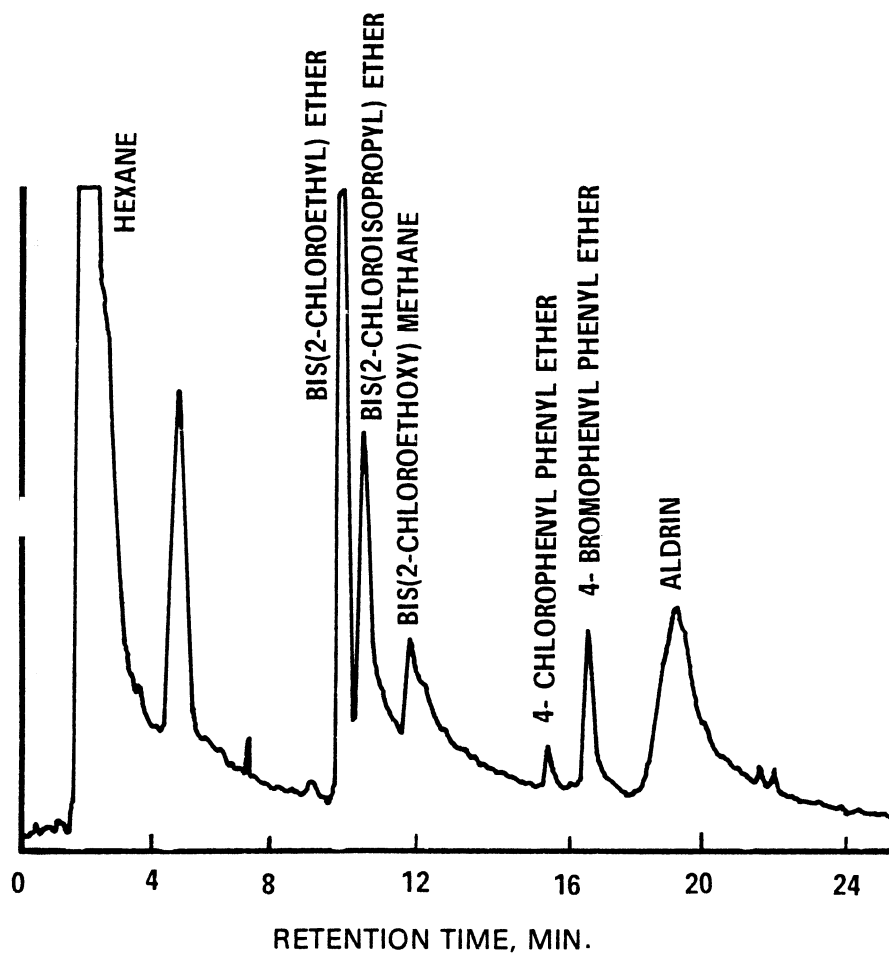

Figure 2. Gas chromatogram of haloethers.

METHOD 612—CHLORINATED HYDROCARBONS

1. Scope and Application

1.1 This method covers the determination of certain chlorinated hydrocarbons. The following parameters can be determined by this method:

| Parameter | STORET No. | CAS No. |
|---------------------------------|------------|----------|
| 2-Chloronaphthalene | 34581 | 91-58-7 |
| 1,2-Dichlorobenzene | 34536 | 95-50-1 |
| 1,3-Dichlorobenzene | 34566 | 541-73-1 |
| 1,4-Dichlorobenzene | 34571 | 106-46-7 |
| Hexachlorobenzene | 39700 | 118-74-1 |
| Hexachlorobutadiene | 34391 | 87-68-3 |
| Hexachlorocyclopentadiene | 34386 | 77-47-4 |
| Hexachloroethane | 34396 | 67-72-1 |

| Parameter | STORET No. | CAS No. |
|------------------------------|------------|----------|
| 1,2,4-Trichlorobenzene | 34551 | 120-82-1 |

1.2 This is a gas chromatographic (GC) method applicable to the determination of the compounds listed above in municipal and industrial discharges as provided under 40 CFR 136.1. When this method is used to analyze unfamiliar samples for any or all of the compounds above, compound identifications should be supported by at least one additional qualitative technique. This method describes a second gas chromatographic column that can be used to confirm measurements made with the primary column. Method 625 provides gas chromatograph/mass spectrometer (GC/MS) conditions appropriate for the qualitative and quantitative confirmation of results for all of the parameters listed above, using the extract produced by this method.

1.3 The method detection limit (MDL, defined in Section 14.1)¹ for each parameter is listed in Table 1. The MDL for a specific wastewater may differ from those listed, depending upon the nature of interferences in the sample matrix.

1.4 The sample extraction and concentration steps in this method are essentially the same as in Methods 606, 608, 609, and 611. Thus, a single sample may be extracted to measure the parameters included in the scope of each of these methods. When cleanup is required, the concentration levels must be high enough to permit selecting aliquots, as necessary, to apply appropriate cleanup procedures. The analyst is allowed the latitude, under Section 12, to select chromatographic conditions appropriate for the simultaneous measurement of combinations of these parameters.

1.5 Any modification of this method, beyond those expressly permitted, shall be considered as a major modification subject to application and approval of alternate test procedures under 40 CFR 136.4 and 136.5.

1.6 This method is restricted to use by or under the supervision of analysts experienced in the use of a gas chromatograph and in the interpretation of gas chromatograms. Each analyst must demonstrate the ability to generate acceptable results with this method using the procedure described in Section 8.2.

2. Summary of Method

2.1 A measured volume of sample, approximately 1-L, is extracted with methylene chloride using a separatory funnel. The methylene chloride extract is dried and exchanged to hexane during concentration to a volume of 10 mL or less. The extract is separated by gas chromatography and the parameters are then measured with an electron capture detector.²

2.2 The method provides a Florisil column cleanup procedure to aid in the elimination of interferences that may be encountered.

3. Interferences

3.1 Method interferences may be caused by contaminants in solvents, reagents, glassware, and other sample processing hardware that lead to discrete artifacts and/or elevated baselines in gas chromatograms. All of these materials must be routinely demonstrated to be free from interferences under the conditions of the analysis by running laboratory reagent blanks as described in Section 8.1.3.

3.1.1 Glassware must be scrupulously cleaned.³ Clean all glassware as soon as possible after use by rinsing with the last solvent used in it. Solvent rinsing should be followed by detergent washing with hot water, and rinses with tap water and distilled water. The glassware should then be drained dry, and heated in a muffle furnace at 400 °C for 15 to 30 min. Some thermally stable materials, such as PCBs, may not be eliminated by this treatment. Solvent rinses with acetone and pesticide quality hexane may be substituted for the muffle furnace heating. Thorough rinsing with such solvents usually eliminates PCB interference. Volumetric ware should not be heated in a muffle furnace. After drying and cooling, glassware should be sealed and stored in a clean environment to prevent any accumulation of dust or other contaminants. Store inverted or capped with aluminum foil.

3.1.2 The use of high purity reagents and solvents helps to minimize interference problems. Purification of solvents by distillation in all-glass systems may be required.

3.2 Matrix interferences may be caused by contaminants that are co-extracted from the sample. The extent of matrix interferences will vary considerably from source to source, depending upon the nature and diversity of the industrial complex or municipality being sampled. The cleanup procedure in Section 11 can be used to overcome many of these interferences, but unique samples may require additional cleanup approaches to achieve the MDL listed in Table 1.

4. Safety

4.1 The toxicity or carcinogenicity of each reagent used in this method has not been precisely defined; however, each chemical compound should be treated as a potential health hazard. From this viewpoint, exposure to these chemicals must be reduced to the lowest possible level by whatever means available. The laboratory is responsible for maintaining a current awareness file of OSHA regulations regarding the safe handling of the chemicals specified in this method. A reference file of material data handling sheets should also be made available to all

personnel involved in the chemical analysis. Additional references to laboratory safety are available and have been identified⁴⁻⁶ for the information of the analyst.

5. Apparatus and Materials

5.1 Sampling equipment, for discrete or composite sampling.

5.1.1 Grab sample bottle—1-cL or 1-qt, amber glass, fitted with a screw cap lined with Teflon. Foil may be substituted for Teflon if the sample is not corrosive. If amber bottles are not available, protect samples from light. The bottle and cap liner must be washed, rinsed with acetone or methylene chloride, and dried before use to minimize contamination.

5.1.2 Automatic sampler (optional)—The sampler must incorporate glass sample containers for the collection of a minimum of 250 mL of sample. Sample containers must be kept refrigerated at 4 °C and protected from light during compositing. If the sampler uses a peristaltic pump, a minimum length of compressible silicone rubber tubing may be used. Before use, however, the compressible tubing should be thoroughly rinsed with methanol, followed by repeated rinsings with distilled water to minimize the potential for contamination of the sample. An integrating flow meter is required to collect flow proportional composites.

5.2 Glassware (All specifications are suggested. Catalog numbers are included for illustration only.):

5.2.1 Separatory funnel—2-L, with Teflon stopcock.

5.2.2 Drying column—Chromatographic column, approximately 400 mm long × 19 mm ID, with coarse frit filter disc.

5.2.3 Chromatographic column—300 long × 10 mm ID, with Teflon stopcock and coarse frit filter disc at bottom.

5.2.4 Concentrator tube, Kuderna-Danish—10-mL, graduated (Kontes K-570050-1025 or equivalent). Calibration must be checked at the volumes employed in the test. Ground glass stopper is used to prevent evaporation of extracts.

5.2.5 Evaporative flask, Kuderna-Danish—500-mL (Kontes K-570001-0500 or equivalent). Attach to concentrator tube with springs.

5.2.6 Snyder column, Kuderna-Danish—Three-ball macro (Kontes K-503000-0121 or equivalent).

5.2.7 Vials—10 to 15-mL, amber glass, with Teflon-lined screw cap.

5.3 Boiling chips—Approximately 10/40 mesh. Heat to 400 °C for 30 min or Soxhlet extract with methylene chloride.

5.4 Water bath—Heated, with concentric ring cover, capable of temperature control (±2 °C). The bath should be used in a hood.

5.5 Balance—Analytical, capable of accurately weighing 0.0001 g.

5.6 Gas chromatograph—An analytical system complete with gas chromatograph

suitable for on-column injection and all required accessories including syringes, analytical columns, gases, detector, and strip-chart recorder. A data system is recommended for measuring peak areas.

5.6.1 Column 1—1.8 m long × 2 mm ID glass, packed with 1% SP-1000 on Supelcoport (100/120 mesh) or equivalent. Guidelines for the use of alternate column packings are provide in Section 12.1.

5.6.2 Column 2—1.8 m long × 2 mm ID glass, packed with 1.5% OV-1/2.4% OV-225 on Supelcoport (80/100 mesh) or equivalent. This column was used to develop the method performance statements in Section 14.

5.6.3 Detector—Electron capture detector. This detector has proven effective in the analysis of wastewaters for the parameters listed in the scope (Section 1.1), and was used to develop the method performance statements in Section 14. Guidelines for the use of alternate detectors are provided in Section 12.1.

6. Reagents

6.1 Reagent water—Reagent water is defined as a water in which an interferent is not observed at the MDL of the parameters of interest.

6.2 Acetone, hexane, isooctane, methanol, methylene chloride, petroleum ether (boiling range 30 to 60 °C)—Pesticide quality or equivalent.

6.3 Sodium sulfate—(ACS) Granular, anhydrous. Purify heating at 400 °C for 4 h in a shallow tray.

6.4 Florisil—PR grade (60/100 mesh). Purchase activated at 1250 °F and store in the dark in glass containers with ground glass stoppers or foil-lined screw caps. Before use, activate each batch at least 16 h at 130 °C in a foil-covered glass container and allow to cool.

6.5 Stock standard solution (1.00 µg/µL)—Stock standard solutions can be prepared from pure standard materials or purchased as certified solutions.

6.5.1 Prepare stock standard solutions by accurately weighing about 0.0100 g of pure material. Dissolve the material in isooctane and dilute to volume in a 120-mL volumetric flask. Larger volumes can be used at the convenience of the analyst. When compound purity is assayed to be 96% or greater, the weight can be used without correction to calculate the concentration of the stock standard. Commercially prepared stock standards can be used at any concentration if they are certified by the manufacturer or by an independent source.

6.5.2 Transfer the stock standard solutions into Teflon-sealed screw-cap bottles. Store at 4 °C and protect from light. Stock standard solutions should be checked frequently for signs of degradation or evaporation, especially just prior to preparing calibration standards from them.

Environmental Protection Agency

Pt. 136, App. A, Meth. 612

6.5.3 Stock standard solutions must be replaced after six months, or sooner if comparison with check standards indicates a problem.

6.6 Quality control check sample concentrate—See Section 8.2.1.

7. Calibration

7.1 Establish gas chromatographic operating conditions equivalent to those given in Table 1. The gas chromatographic system can be calibrated using the external standard technique (Section 7.2) or the internal standard technique (Section 7.3).

7.2 External standard calibration procedure:

7.2.1 Prepare calibration standards at a minimum of three concentration levels for each parameter of interest by adding volumes of one or more stock standards to a volumetric flask and diluting to volume with isooctane. One of the external standards should be at a concentration near, but above, the MDL (Table 1) and the other concentrations should correspond to the expected range of concentrations found in real samples or should define the working range of the detector.

7.2.2 Using injections of 2 to 5 μL , analyze each calibration standard according to Section 12 and tabulate peak height or area responses against the mass injected. The results can be used to prepare a calibration curve for each compound. Alternatively, if the ratio of response to amount injected (calibration factor) is a constant over the working range (<10% relative standard deviation, RSD), linearity through the origin can be assumed and the average ratio or calibration factor can be used in place of a calibration curve.

7.3 Internal standard calibration procedure—To use this approach, the analyst must select one or more internal standards that are similar in analytical behavior to the compounds of interest. The analyst must further demonstrate that the measurement of the internal standard is not affected by method or matrix interferences. Because of these limitations, no internal standard can be suggested that is applicable to all samples.

7.3.1 Prepare calibration standards at a minimum of three concentration levels for each parameter of interest by adding volumes of one or more stock standards to a volumetric flask. To each calibration standard, add a known constant amount of one or more internal standards, and dilute to volume with isooctane. One of the standards should be at a concentration near, but above, the MDL and the other concentrations should correspond to the expected range of concentrations found in real samples or should define the working range of the detector.

7.3.2 Using injections of 2 to 5 μL , analyze each calibration standard according to Section 12 and tabulate peak height or area responses against concentration for each compound and internal standard. Calculate response factors (RF) for each compound using Equation 1.

$$\text{RF} = \frac{(A_s)(C_{is})}{(A_{is})(C_s)}$$

Equation 1

where:

A_s = Response for the parameter to be measured.

A_{is} = Response for the internal standard.

C_{is} = Concentration of the internal standard ($\mu\text{g/L}$).

C_s = Concentration of the parameter to be measured ($\mu\text{g/L}$).

If the RF value over the working range is a constant (<10% RSD), the RF can be assumed to be invariant and the average RF can be used for calculations. Alternatively, the results can be used to plot a calibration curve of response ratios, A_s/A_{is} , vs. RF.

7.4 The working calibration curve, calibration factor, or RF must be verified on each working day by the measurement of one or more calibration standards. If the response for any parameter varies from the predicted response by more than $\pm 15\%$, a new calibration curve must be prepared for that compound.

7.5 Before using any cleanup procedure, the analyst must process a series of calibration standards through the procedure to validate elution patterns and the absence of interferences from the reagents.

8. Quality Control

8.1 Each laboratory that uses this method is required to operate a formal quality control program. The minimum requirements of this program consist of an initial demonstration of laboratory capability and an ongoing analysis of spiked samples to evaluate and document data quality. The laboratory must maintain records to document the quality of data that is generated. Ongoing data quality checks are compared with established performance criteria to determine if the results of analyses meet the performance characteristics of the method. When the results of sample spikes indicate atypical method performance, a quality control check standard must be analyzed to confirm that the measurements were performed in an in-control mode of operation.

8.1.1 The analyst must make an initial, one-time, demonstration of the ability to generate acceptable accuracy and precision with this method. This ability is established as described in Section 8.2.

8.1.2 In recognition of advances that are occurring in chromatography, the analyst is permitted certain options (detailed in Sections 10.4, 11.1, and 12.1) to improve the separations or lower the cost of measurements. Each time such modification is made to the method, the analyst is required to repeat the procedure in Section 8.2.

8.1.3 Before processing any samples, the analyst must analyze a reagent water blank to demonstrate that interferences from the analytical system and glassware are under control. Each time a set of samples is extracted or reagents are changed, a reagent water blank must be processed as a safeguard against laboratory contamination.

8.1.4 The laboratory must, on an ongoing basis, spike and analyze a minimum of 10% of all samples to monitor and evaluate laboratory data quality. This procedure is described in Section 8.3.

8.1.5 The laboratory must, on an ongoing basis, demonstrate through the analyses of quality control check standards that the operation of the measurement system is in control. This procedure is described in Section 8.4. The frequency of the check standard analyses is equivalent to 10% of all samples analyzed but may be reduced if spike recoveries from samples (Section 8.3) meet all specified quality control criteria.

8.1.6 The laboratory must maintain performance records to document the quality of data that is generated. This procedure is described in Section 8.5.

8.2 To establish the ability to generate acceptable accuracy and precision, the analyst must perform the following operations.

8.2.1 A quality control (QC) check sample concentrate is required containing each parameter of interest at the following concentrations in acetone: Hexachloro-substituted parameters, 10 µg/mL; any other chlorinated hydrocarbon, 100 µg/mL. The QC check sample concentrate must be obtained from the U.S. Environmental Protection Agency, Environmental Monitoring and Support Laboratory in Cincinnati, Ohio, if available. If not available from that source, the QC check sample concentrate must be obtained from another external source. If not available from either source above, the QC check sample concentrate must be prepared by the laboratory using stock standards prepared independently from those used for calibration.

8.2.2 Using a pipet, prepare QC check samples at the test concentrations shown in Table 2 by adding 1.00 mL of QC check sample concentrate to each of four 1-L aliquots of reagent water.

8.2.3 Analyze the well-mixed QC check samples according to the method beginning in Section 10.

8.2.4 Calculate the average recovery (\bar{X}) in µg/L, and the standard deviation of the re-

covery (s) in µg/L, for each parameter using the four results.

8.2.5 For each parameter compare s and \bar{X} with the corresponding acceptance criteria for precision and accuracy, respectively, found in Table 2. If s and \bar{X} for all parameters of interest meet the acceptance criteria, the system performance is acceptable and analysis of actual samples can begin. If any individual s exceeds the precision limit or any individual \bar{X} falls outside the range for accuracy, the system performance is unacceptable for that parameter.

NOTE: The large number of parameters in Table 2 presents a substantial probability that one or more will fail at least one of the acceptance criteria when all parameters are analyzed.

8.2.6 When one or more of the parameters tested fail at least one of the acceptance criteria, the analyst must proceed according to Section 8.2.6.1 or 8.2.6.2.

8.2.6.1 Locate and correct the source of the problem and repeat the test for all parameters of interest beginning with Section 8.2.2.

8.2.6.2 Beginning with Section 8.2.2, repeat the test only for those parameters that failed to meet criteria. Repeated failure, however, will confirm a general problem with the measurement system. If this occurs, locate and correct the source of the problem and repeat the test for all compounds of interest beginning with Section 8.2.2.

8.3 The laboratory must, on an ongoing basis, spike at least 10% of the samples from each sample site being monitored to assess accuracy. For laboratories analyzing one to ten samples per month, at least one spike sample per month is required.

8.3.1 The concentration of the spike in the sample should be determined as follows:

8.3.1.1 If, as in compliance monitoring, the concentration of a specific parameter in the sample is being checked against a regulatory concentration limit, the spike should be at that limit or 1 to 5 times higher than the background concentration determined in Section 8.3.2, whichever concentration would be larger.

8.3.1.2 If the concentration of a specific parameter in the sample is not being checked against a limit specific to that parameter, the spike should be at the test concentration in Section 8.2.2 or 1 to 5 times higher than the background concentration determined in Section 8.3.2, whichever concentration would be larger.

8.3.1.3 If it is impractical to determine background levels before spiking (e.g., maximum holding times will be exceeded), the spike concentration should be (1) the regulatory concentration limit, if any; or, if none by (2) the larger of either 5 times higher than the expected background concentration or the test concentration in Section 8.2.2.

8.3.2 Analyze one sample aliquot to determine the background concentration (B) of each parameter. In necessary, prepare a new QC check sample concentrate (Section 8.2.1) appropriate for the background concentrations in the sample. Spike a second sample aliquot with 1.0 mL of the QC check sample concentrate and analyze it to determine the concentration after spiking (A) of each parameter. Calculate each percent recovery (P) as $100(A-B)/T$, where T is the known true value of the spike.

8.3.3 Compare the percent recovery (P) for each parameter with the corresponding QC acceptance criteria found in Table 2. These acceptance criteria were calculated to include an allowance for error in measurement of both the background and spike concentrations, assuming a spike to background ratio of 5:1. This error will be accounted for to the extent that the analyst's spike to background ratio approaches 5:1.⁷ If spiking was performed at a concentration lower than the test concentration in Section 8.2.2, the analyst must use either the QC acceptance criteria in Table 2, or optional QC acceptance criteria calculated for the specific spike concentration. To calculate optional acceptance criteria for the recovery of a parameter: (1) Calculate accuracy (X') using the equation in Table 3, substituting the spike concentration (T) for C; (2) calculate overall precision (S') using the equation in Table 3, substituting X' for X; (3) calculate the range for recovery at the spike concentration as $(100 X'/T) \pm 2.44 (100 S'/T)\%$.⁷

8.3.4 If any individual P falls outside the designated range for recovery, that parameter has failed the acceptance criteria. A check standard containing each parameter that failed the criteria must be analyzed as described in Section 8.4.

8.4. If any parameter fails the acceptance criteria for recovery in Section 8.3, a QC check standard containing each parameter that failed must be prepared and analyzed.

NOTE: The frequency for the required analysis of a QC check standard will depend upon the number of parameters being simultaneously tested, the complexity of the sample matrix, and the performance of the laboratory.

8.4.1 Prepare the QC check standard by adding 1.0 mL of QC check sample concentrate (Sections 8.2.1 or 8.3.2) to 1 L of reagent water. The QC check standard needs only to contain the parameters that failed criteria in the test in Section 8.3.

8.4.2 Analyze the QC check standard to determine the concentration measured (A) of each parameter. Calculate each percent recovery (P_s) as $100(A/T)\%$, where T is the true value of the standard concentration.

8.4.3 Compare the percent recovery (P_s) for each parameter with the corresponding QC acceptance criteria found in Table 2. Only parameters that failed the test in Section 8.3

need to be compared with these criteria. If the recovery of any such parameter falls outside the designated range, the laboratory performance for that parameter is judged to be out of control, and the problem must be immediately identified and corrected. The analytical result for that parameter in the unspiked sample is suspect and may not be reported for regulatory compliance purposes.

8.5 As part of the QC program for the laboratory, method accuracy for wastewater samples must be assessed and records must be maintained. After the analysis of five spiked wastewater samples as in Section 8.3, calculate the average percent recovery (\bar{P}) and the standard deviation of the percent recovery (s_p). Express the accuracy assessment as a percent recovery interval from $P - 2s_p$ to $P + 2s_p$. If $P=90\%$ and $s_p=10\%$, for example, the accuracy interval is expressed as 70-110%. Update the accuracy assessment for each parameter on a regular basis (e.g. after each five to ten new accuracy measurements).

8.6 It is recommended that the laboratory adopt additional quality assurance practices for use with this method. The specific practices that are most productive depend upon the needs of the laboratory and the nature of the samples. Field duplicates may be analyzed to assess the precision of the environmental measurements. When doubt exists over the identification of a peak on the chromatogram, confirmatory techniques such as gas chromatography with a dissimilar column, specific element detector, or mass spectrometer must be used. Whenever possible, the laboratory should analyze standard reference materials and participate in relevant performance evaluation studies.

9. Sample Collection, Preservation, and Handling

9.1 Grab samples must be collected in glass containers. Conventional sampling practices⁸ should be followed, except that the bottle must not be prerinsed with sample before collection. Composite samples should be collected in refrigerated glass containers in accordance with the requirements of the program. Automatic sampling equipment must be as free as possible of Tygon tubing and other potential sources of contamination.

9.2 All samples must be iced or refrigerated at 4°C from the time of collection until extraction.

9.3 All samples must be extracted within 7 days of collection and completely analyzed within 40 days of extraction.²

10. Sample Extraction

10.1 Mark the water meniscus on the side of the sample bottle for later determination of sample volume. Pour the entire sample into a 2-L separatory funnel.

10.2 Add 60 mL of methylene chloride to the sample bottle, seal, and shake 30 s to rinse the inner surface. Transfer the solvent to the separatory funnel and extract the sample by shaking the funnel for 2 min with periodic venting to release excess pressure. Allow the organic layer to separate from the water phase for a minimum of 10 min. If the emulsion interface between layers is more than one-third the volume of the solvent layer, the analyst must employ mechanical techniques to complete the phase separation. The optimum technique depends upon the sample, but may include stirring, filtration of the emulsion through glass wool, centrifugation, or other physical methods. Collect the methylene chloride extract in a 250-mL Erlenmeyer flask.

10.3 Add a second 60-mL volume of methylene chloride to the sample bottle and repeat the extraction procedure a second time, combining the extracts in the Erlenmeyer flask. Perform a third extraction in the same manner.

10.4 Assemble a Kuderna-Danish (K-D) concentrator by attaching a 10-mL concentrator tube to a 500-mL evaporative flask. Other concentration devices or techniques may be used in place of the K-D concentrator if the requirements of Section 8.2 are met.

10.5 Pour the combined extract through a solvent-rinsed drying column containing about 10 cm of anhydrous sodium sulfate, and collect the extract in the K-D concentrator. Rinse the Erlenmeyer flask and column with 20 to 30 mL of methylene chloride to complete the quantitative transfer.

10.6 Add one or two clean boiling chips to the evaporative flask and attach a three-ball Snyder column. Prewet the Snyder column by adding about 1 mL of methylene chloride to the top. Place the K-D apparatus on a hot water bath (60 to 65 °C) so that the concentrator tube is partially immersed in the hot water, and the entire lower rounded surface of the flask is bathed with hot vapor. Adjust the vertical position of the apparatus and the water temperature as required to complete the concentration in 15 to 20 min. At the proper rate of distillation the balls of the column will actively chatter but the chambers will not flood with condensed solvent. When the apparent volume of liquid reaches 1 to 2 mL, remove the K-D apparatus and allow it to drain and cool for at least 10 min.

NOTE: The dichlorobenzenes have a sufficiently high volatility that significant losses may occur in concentration steps if care is not exercised. It is important to maintain a constant gentle evaporation rate and not to allow the liquid volume to fall below 1 to 2 mL before removing the K-D apparatus from the hot water bath.

10.7 Momentarily remove the Snyder column, add 50 mL of hexane and a new boiling chip, and reattach the Snyder column. Raise the temperature of the water bath to 85 to 90

°C. Concentrate the extract as in Section 10.6, except use hexane to prewet the column. The elapsed time of concentration should be 5 to 10 min.

10.8 Remove the Snyder column and rinse the flask and its lower joint into the concentrator tube with 1 to 2 mL of hexane. A 5-mL syringe is recommended for this operation. Stopper the concentrator tube and store refrigerated if further processing will not be performed immediately. If the extract will be stored longer than two days, it should be transferred to a Teflon-sealed screw-cap vial. If the sample extract requires no further cleanup, proceed with gas chromatographic analysis (Section 12). If the sample requires further cleanup, proceed to Section 11.

10.9 Determine the original sample volume by refilling the sample bottle to the mark and transferring the liquid to a 1000-mL graduated cylinder. Record the sample volume to the nearest 5 mL.

11. Cleanup and Separation

11.1 Cleanup procedures may not be necessary for a relatively clean sample matrix. If particular circumstances demand the use of a cleanup procedure, the analyst may use the procedure below or any other appropriate procedure. However, the analyst first must demonstrate that the requirements of Section 8.2 can be met using the method as revised to incorporate the cleanup procedure.

11.2 Florisil column cleanup for chlorinated hydrocarbons:

11.2.1 Adjust the sample extract to 10 mL with hexane.

11.2.2 Place 12 g of Florisil into a chromatographic column. Tap the column to settle the Florisil and add 1 to 2 cm of anhydrous sodium sulfate to the top.

11.2.3 Preequilibrate the column with 100 mL of petroleum ether. Discard the eluate and just prior to exposure of the sodium sulfate layer to the air, quantitatively transfer the sample extract onto the column by decantation and subsequent petroleum ether washings. Discard the eluate. Just prior to exposure of the sodium sulfate layer to the air, begin eluting the column with 200 mL of petroleum ether and collect the eluate in a 500-mL K-D flask equipped with a 10-mL concentrator tube. This fraction should contain all of the chlorinated hydrocarbons.

11.2.4 Concentrate the fraction as in Section 10.6, except use hexane to prewet the column. When the apparatus is cool, remove the Snyder column and rinse the flask and its lower joint into the concentrator tube with hexane. Analyze by gas chromatography (Section 12).

12. Gas Chromatography

12.1 Table 1 summarizes the recommended operating conditions for the gas chromatograph. Included in this table are retention times and MDL that can be achieved under these conditions. Examples of the separations achieved by Column 2 are shown in Figures 1 and 2. Other packed or capillary (open-tubular) columns, chromatographic conditions, or detectors may be used if the requirements of Section 8.2 are met.

12.2 Calibrate the system daily as described in Section 7.

12.3 If the internal standard calibration procedure is being used, the internal standard must be added to the sample extract and mixed thoroughly immediately before injection into the gas chromatograph.

12.4 Inject 2 to 5 μL of the sample extract or standard into the gas chromatograph using the solvent-flush technique.⁹ Smaller (1.0 μL) volumes may be injected if automatic devices are employed. Record the volume injected to the nearest 0.05 μL , the total extract volume, and the resulting peak size in area or peak height units.

12.5 Identify the parameters in the sample by comparing the retention times of the peaks in the sample chromatogram with those of the peaks in standard chromatograms. The width of the retention time window used to make identifications should be based upon measurements of actual retention time variations of standards over the course of a day. Three times the standard deviation of a retention time for a compound can be used to calculate a suggested window size; however, the experience of the analyst should weigh heavily in the interpretation of chromatograms.

12.6 If the response for a peak exceeds the working range of the system, dilute the extract and reanalyze.

12.7 If the measurement of the peak response is prevented by the presence of interferences, further cleanup is required.

13. Calculations

13.1 Determine the concentration of individual compounds in the sample.

13.1.1 If the external standard calibration procedure is used, calculate the amount of material injected from the peak response using the calibration curve or calibration factor determined in Section 7.2.2. The concentration in the sample can be calculated from Equation 2.

$$\text{Concentration } (\mu\text{g/L}) = \frac{(A)(V_t)}{(V_i)(V_s)}$$

Equation 2

where:

A=Amount of material injected (ng).

V_i =Volume of extract injected (μL).

V_t =Volume of total extract (μL).

V_s =Volume of water extracted (mL).

13.1.2 If the internal standard calibration procedure is used, calculate the concentration in the sample using the response factor (RF) determined in Section 7.3.2 and Equation 3.

$$\text{Concentration } (\mu\text{g/L}) = \frac{(A_s)(I_s)}{(A_{is})(\text{RF})(V_o)}$$

Equation 3

where:

A_s =Response for the parameter to be measured.

A_{is} =Response for the internal standard.

I_s =Amount of internal standard added to each extract (μg).

V_o =Volume of water extracted (L).

13.2 Report results in $\mu\text{g/L}$ without correction for recovery data. All QC data obtained should be reported with the sample results.

14. Method Performance

14.1 The method detection limit (MDL) is defined as the minimum concentration of a substance that can be measured and reported with 99% confidence that the value is above zero.¹ The MDL concentrations listed in Table 1 were obtained using reagent water.¹⁰ Similar results were achieved using representative wastewaters. The MDL actually achieved in a given analysis will vary depending on instrument sensitivity and matrix effects.

14.2 This method has been tested for linearity of spike recovery from reagent water and has been demonstrated to be applicable over the concentration range from 4 \times MDL to 1000 \times MDL.¹⁰

14.3 This method was tested by 20 laboratories using reagent water, drinking water, surface water, and three industrial wastewaters spiked at six concentrations over the range 1.0 to 356 $\mu\text{g/L}$.¹¹ Single operator precision, overall precision, and method accuracy were found to be directly related to the concentration of the parameter and essentially independent of the sample matrix. Linear equations to describe these relationships are presented in Table 3.

REFERENCES

- 40 CFR part 136, appendix B.
- "Determination of Chlorinated Hydrocarbons in Industrial and Municipal Wastewaters," EPA 6090/4-84-ABC, National Technical Information Service, PBXYZ, Springfield, Virginia, 22161 November 1984.
- ASTM Annual Book of Standards, Part 31, D3694-78. "Standard Practices for Preparation of Sample Containers and for Preservation of Organic Constituents," American

Society for Testing and Materials, Philadelphia.

4. "Carcinogens—Working With Carcinogens," Department of Health, Education, and Welfare, Public Health Service, Center for Disease Control, National Institute for Occupational Safety and Health, Publication No. 77-206, August 1977.

5. "OSHA Safety and Health Standards, General Industry," (29 CFR part 1910), Occupational Safety and Health Administration, OSHA 2206 (Revised, January 1976).

6. "Safety in Academic Chemistry Laboratories," American Chemical Society Publication, Committee on Chemical Safety, 3rd Edition, 1979.

7. Provost, L.P., and Elder, R.S. "Interpretation of Percent Recovery Data," *American Laboratory*, 15, 58-63 (1983). (The value 2.44 used in the equation in Section 8.3.3 is two times the value 1.22 derived in this report.)

8. ASTM Annual Book of Standards, Part 31, D3370-76. "Standard Practices for Sam-

pling Water," American Society for Testing and Materials, Philadelphia.

9. Burke, J.A. "Gas Chromatography for Pesticide Residue Analysis; Some Practical Aspects," *Journal of the Association of Official Analytical Chemists*, 48, 1037 (1965).

10. "Development of Detection Limits, EPA Method 612, Chlorinated Hydrocarbons," Special letter report for EPA Contract 68-03-2625, U.S. Environmental Protection Agency, Environmental Monitoring and Support Laboratory, Cincinnati, Ohio 45268.

11. "EPA Method Study Method 612—Chlorinated Hydrocarbons," EPA 600/4-84-039, National Technical Information Service, PB84-187772, Springfield, Virginia 22161, May 1984.

12. "Method Performance for Hexachlorocyclopentadiene by Method 612," Memorandum from R. Slater, U.S. Environmental Protection Agency, Environmental Monitoring and Support Laboratory, Cincinnati, Ohio 45268, December 7, 1983.

TABLE 1—CHROMATOGRAPHIC CONDITIONS AND METHOD DETECTION LIMITS

| Parameter | Retention time (min) | | Method detection limit (µg/L) |
|---------------------------------|----------------------|-------------------|-------------------------------|
| | Column 1 | Column 2 | |
| 1,3-Dichlorobenzene | 4.5 | 6.8 | 1.19 |
| Hexachloroethane | 4.9 | 8.3 | 0.03 |
| 1,4-Dichlorobenzene | 5.2 | 7.6 | 1.34 |
| 1,2-Dichlorobenzene | 6.6 | 9.3 | 1.14 |
| Hexachlorobutadiene | 7.7 | 20.0 | 0.34 |
| 1,2,4-Trichlorobenzene | 15.5 | 22.3 | 0.05 |
| Hexachlorocyclopentadiene | nd | ^c 16.5 | 0.40 |
| 2-Chloronaphthalene | ^a 2.7 | ^b 3.6 | 0.94 |
| Hexachlorobenzene | ^a 5.6 | ^b 10.1 | 0.05 |

Column 1 conditions: Supelcoport (100/120 mesh) coated with 1% SP-1000 packed in a 1.8 m x 2 mm ID glass column with 5% methane/95% argon carrier gas at 25 mL/min. flow rate. Column temperature held isothermal at 65 °C, except where otherwise indicated.

Column 2 conditions: Supelcoport (80/100 mesh) coated with 1.5% OV-1/2.4% OV-225 packed in a 1.8 m x 2 mm ID glass column with 5% methane/95% argon carrier gas at 25 mL/min. flow rate. Column temperature held isothermal at 75 °C, except where otherwise indicated.

nd=Not determined.

^a 150 °C column temperature.

^b 165 °C column temperature.

^c 100 °C column temperature.

TABLE 2—QC ACCEPTANCE CRITERIA—METHOD 612

| Parameter | Test conc. (µg/L) | Limit for s (µg/L) | Range for X̄ (µg/L) | Range for P, P _s (percent) |
|---------------------------------|-------------------|--------------------|---------------------|---------------------------------------|
| 2-Chloronaphthalene | 100 | 37.3 | 29.5-126.9 | 9-148 |
| 1,2-Dichlorobenzene | 100 | 28.3 | 23.5-145.1 | 9-160 |
| 1,3-Dichlorobenzene | 100 | 26.4 | 7.2-138.6 | D-150 |
| 1,4-Dichlorobenzene | 100 | 20.8 | 22.7-126.9 | 13-137 |
| Hexachlorobenzene | 10 | 2.4 | 2.6-14.8 | 15-159 |
| Hexachlorobutadiene | 10 | 2.2 | D-12.7 | D-139 |
| Hexachlorocyclopentadiene | 10 | 2.5 | D-10.4 | D-111 |
| Hexachloroethane | 10 | 3.3 | 2.4-12.3 | 8-139 |
| 1,2,4-Trichlorobenzene | 100 | 31.6 | 20.2-133.7 | 5-149 |

s=Standard deviation of four recovery measurements, in µg/L (Section 8.2.4).

X̄=Average recovery for four recovery measurements, in µg/L (Section 8.2.4).

P, P_s=Percent recovery measured (Section 8.3.2, Section 8.4.2).

D=Detected; result must be greater than zero.

NOTE: These criteria are based directly upon the method performance data in Table 3. Where necessary, the limits for recovery have been broadened to assure applicability of the limits to concentrations below those used to develop Table 3.

TABLE 3—METHOD ACCURACY AND PRECISION AS FUNCTIONS OF CONCENTRATION—METHOD 612

| Parameter | Accuracy, as recovery, X' ($\mu\text{g/L}$) | Single analyst precision, s'_i ($\mu\text{g/L}$) | Overall precision, S' ($\mu\text{g/L}$) |
|--|---|--|---|
| 2-Chloronaphthalene | $0.75C+3.21$ | $0.28\bar{X} - 1.17$ | $0.38\bar{X} - 1.39$ |
| 1,2-Dichlorobenzene | $0.85C - 0.70$ | $0.22\bar{X} - 2.95$ | $0.41\bar{X} - 3.92$ |
| 1,3-Dichlorobenzene | $0.72C+0.87$ | $0.21\bar{X} - 1.03$ | $0.49\bar{X} - 3.98$ |
| 1,4-Dichlorobenzene | $0.72C+2.80$ | $0.16\bar{X} - 0.48$ | $0.35\bar{X} - 0.57$ |
| Hexachlorobenzene | $0.87C - 0.02$ | $0.14\bar{X}+0.07$ | $0.36\bar{X} - 0.19$ |
| Hexachlorobutadiene | $0.61C+0.03$ | $0.18\bar{X}+0.08$ | $0.53\bar{X} - 0.12$ |
| Hexachlorocyclopentadiene ^a | $0.47C$ | $0.24\bar{X}$ | $0.50\bar{X}$ |
| Hexachloroethane | $0.74C - 0.02$ | $0.23\bar{X}+0.07$ | $0.36\bar{X} - 0.00$ |
| 1,2,4-Trichlorobenzene | $0.76C+0.98$ | $0.23\bar{X} - 0.44$ | $0.40\bar{X} - 1.37$ |

X' =Expected recovery for one or more measurements of a sample containing a concentration of C , in $\mu\text{g/L}$.

s'_i =Expected single analyst standard deviation of measurements at an average concentration found of \bar{X} , in $\mu\text{g/L}$.

S' =Expected interlaboratory standard deviation of measurements at an average concentration found of \bar{X} , in $\mu\text{g/L}$.

C =True value for the concentration, in $\mu\text{g/L}$.

\bar{X} =Average recovery found for measurements of samples containing a concentration of C , in $\mu\text{g/L}$.

^a Estimates based upon the performance in a single laboratory.¹²

COLUMN: 1.5% OV-1/2.4% OV-225 ON SUPELCOPORT

TEMPERATURE: 75°C

DETECTOR: ELECTRON CAPTURE

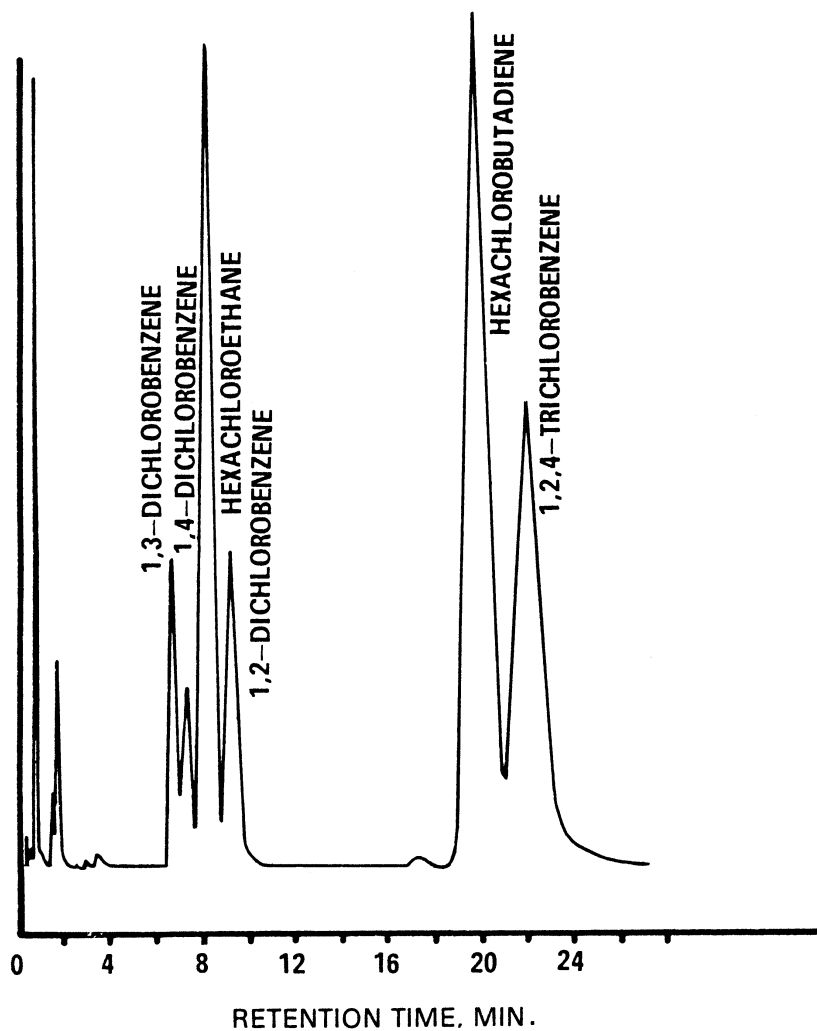

Figure 1. Gas chromatogram of chlorinated hydrocarbons.

COLUMN: 1.5% OV-1/2.4% OV-225 ON SUPELCOPORT
TEMPERATURE: 165°C
DETECTOR: ELECTRON CAPTURE

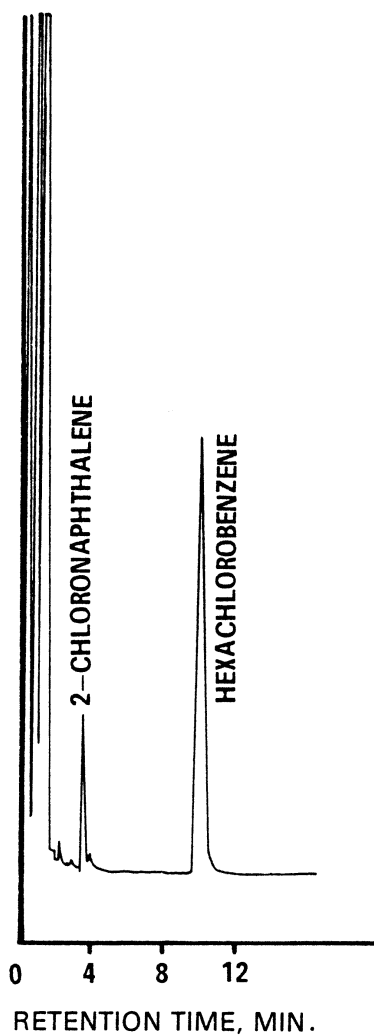

Figure 2. Gas chromatogram of chlorinated hydrocarbons.

METHOD 613—2,3,7,8-TETRACHLORODIBENZO-P-DIOXIN

3. Interferences

1. Scope and Application

1.1 This method covers the determination of 2,3,7,8-tetrachlorodibenzo-p-dioxin (2,3,7,8-TCDD). The following parameter may be determined by this method:

| Parameter | STORET No. | GAS No. |
|--------------------|------------|-----------|
| 2,3,7,8-TCDD | 34675 | 1746-01-6 |

1.2 This is a gas chromatographic/mass spectrometer (GC/MS) method applicable to the determination of 2,3,7,8-TCDD in municipal and industrial discharges as provided under 40 CFR 136.1. Method 625 may be used to screen samples for 2,3,7,8-TCDD. When the screening test is positive, the final qualitative confirmation and quantification must be made using Method 613.

1.3 The method detection limit (MDL, defined in Section 14.1)¹ for 2,3,7,8-TCDD is listed in Table 1. The MDL for a specific wastewater may be different from that listed, depending upon the nature of interferences in the sample matrix.

1.4 Because of the extreme toxicity of this compound, the analyst must prevent exposure to himself, of to others, by materials known or believed to contain 2,3,7,8-TCDD. Section 4 of this method contains guidelines and protocols that serve as minimum safe-handling standards in a limited-access laboratory.

1.5 Any modification of this method, beyond those expressly permitted, shall be considered as a major modification subject to application and approval of alternate test procedures under 40 CFR 136.4 and 136.5.

1.6 This method is restricted to use by or under the supervision of analysts experienced in the use of a gas chromatograph/mass spectrometer and in the interpretation of mass spectra. Each analyst must demonstrate the ability to generate acceptable results with this method using the procedure described in Section 8.2.

2. Summary of Method

2.1 A measured volume of sample, approximately 1-L, is spiked with an internal standard of labeled 2,3,7,8-TCDD and extracted with methylene chloride using a separatory funnel. The methylene chloride extract is exchanged to hexane during concentration to a volume of 1.0 mL or less. The extract is then analyzed by capillary column GC/MS to separate and measure 2,3,7,8-TCDD.^{2,3}

2.2 The method provides selected column chromatographic cleanup procedures to aid in the elimination of interferences that may be encountered.

3.1 Method interferences may be caused by contaminants in solvents, reagents, glassware, and other sample processing hardware that lead to discrete artifacts and/or elevated backgrounds at the masses (m/z) monitored. All of these materials must be routinely demonstrated to be free from interferences under the conditions of the analysis by running laboratory reagent blanks as described in Section 8.1.3.

3.1.1 Glassware must be scrupulously cleaned.⁴ Clean all glassware as soon as possible after use by rinsing with the last solvent used in it. Solvent rinsing should be followed by detergent washing with hot water, and rinses with tap water and distilled water. The glassware should then be drained dry, and heated in a muffle furnace at 400 °C for 15 to 30 min. Some thermally stable materials, such as PCBs, may not be eliminated by the treatment. Solvent rinses with acetone and pesticide quality hexane may be substituted for the muffle furnace heating. Thorough rinsing with such solvents usually eliminates PCB interference. Volumetric ware should not be heated in a muffle furnace. After drying and cooling, glassware should be sealed and stored in a clean environment to prevent any accumulation of dust or other contaminants. Store inverted or capped with aluminum foil.

3.1.2 The use of high purity reagents and solvents helps to minimize interference problems. Purification of solvents by distillation in all-glass systems may be required.

3.2 Matrix interferences may be caused by contaminants that are coextracted from the sample. The extent of matrix interferences will vary considerably from source to source, depending upon the nature and diversity of the industrial complex or municipality being sampled. 2,3,7,8-TCDD is often associated with other interfering chlorinated compounds which are at concentrations several magnitudes higher than that of 2,3,7,8-TCDD. The cleanup procedures in Section 11 can be used to overcome many of these interferences, but unique samples may require additional cleanup approaches^{1,5M7} to eliminate false positives and achieve the MDL listed in Table 1.

3.3 The primary column, SP-2330 or equivalent, resolves 2,3,7,8-TCDD from the other 21 TCDD isomers. Positive results using any other gas chromatographic column must be confirmed using the primary column.

4. Safety

4.1 The toxicity or carcinogenicity of each reagent used in this method has not been precisely defined; however, each chemical compound should be treated as a potential health hazard. From this viewpoint, exposure to these chemicals must be reduced to

the lowest possible level by whatever means available. The laboratory is responsible for maintaining a current awareness file of OSHA regulations regarding the safe handling of the chemicals specified in this method. A reference file of material data handling sheets should also be made available to all personnel involved in the chemical analysis. Additional references to laboratory safety are available and have been identified⁸⁻¹⁰ for the information of the analyst. Benzene and 2,3,7,8-TCDD have been identified as suspected human or mammalian carcinogens.

4.2 Each laboratory must develop a strict safety program for handling 2,3,7,8-TCDD. The following laboratory practices are recommended:

4.2.1 Contamination of the laboratory will be minimized by conducting all manipulations in a hood.

4.2.2 The effluents of sample splitters for the gas chromatograph and roughing pumps on the GC/MS should pass through either a column of activated charcoal or be bubbled through a trap containing oil or high-boiling alcohols.

4.2.3 Liquid waste should be dissolved in methanol or ethanol and irradiated with ultraviolet light with a wavelength greater than 290 nm for several days. (Use F 40 BL lamps or equivalent). Analyze liquid wastes and dispose of the solutions when 2,3,7,8-TCDD can no longer be detected.

4.3 Dow Chemical U.S.A. has issued the following precautions (revised November 1978) for safe handling of 2,3,7,8-TCDD in the laboratory:

4.3.1 The following statements on safe handling are as complete as possible on the basis of available toxicological information. The precautions for safe handling and use are necessarily general in nature since detailed, specific recommendations can be made only for the particular exposure and circumstances of each individual use. Inquiries about specific operations or uses may be addressed to the Dow Chemical Company. Assistance in evaluating the health hazards of particular plant conditions may be obtained from certain consulting laboratories and from State Departments of Health or of Labor, many of which have an industrial health service. 2,3,7,8-TCDD is extremely toxic to laboratory animals. However, it has been handled for years without injury in analytical and biological laboratories. Techniques used in handling radioactive and infectious materials are applicable to 2,3,7,8-TCDD.

4.3.1.1 Protective equipment—Throw-away plastic gloves, apron or lab coat, safety glasses, and a lab hood adequate for radioactive work.

4.3.1.2 Training—Workers must be trained in the proper method of removing contaminated gloves and clothing without contacting the exterior surfaces.

4.3.1.3 Personal hygiene—Thorough washing of hands and forearms after each manipulation and before breaks (coffee, lunch, and shift).

4.3.1.4 Confinement—Isolated work area, posted with signs, segregated glassware and tools, plastic-backed absorbent paper on benchtops.

4.3.1.5 Waste—Good technique includes minimizing contaminated waste. Plastic bag liners should be used in waste cans. Janitors must be trained in the safe handling of waste.

4.3.1.6 Disposal of wastes—2,3,7,8-TCDD decomposes above 800 °C. Low-level waste such as absorbent paper, tissues, animal remains, and plastic gloves may be burned in a good incinerator. Gross quantities (milligrams) should be packaged securely and disposed through commercial or governmental channels which are capable of handling high-level radioactive wastes or extremely toxic wastes. Liquids should be allowed to evaporate in a good hood and in a disposable container. Residues may then be handled as above.

4.3.1.7 Decontamination—For personal decontamination, use any mild soap with plenty of scrubbing action. For decontamination of glassware, tools, and surfaces, Chlorothene NU Solvent (Trademark of the Dow Chemical Company) is the least toxic solvent shown to be effective. Satisfactory cleaning may be accomplished by rinsing with Chlorothene, then washing with any detergent and water. Dishwater may be disposed to the sewer. It is prudent to minimize solvent wastes because they may require special disposal through commercial sources which are expensive.

4.3.1.8 Laundry—Clothing known to be contaminated should be disposed with the precautions described under Section 4.3.1.6. Lab coats or other clothing worn in 2,3,7,8-TCDD work areas may be laundered.

Clothing should be collected in plastic bags. Persons who convey the bags and launder the clothing should be advised of the hazard and trained in proper handling. The clothing may be put into a washer without contact if the launderer knows the problem. The washer should be run through a cycle before being used again for other clothing.

4.3.1.9 Wipe tests—A useful method of determining cleanliness of work surfaces and tools is to wipe the surface with a piece of filter paper. Extraction and analysis by gas chromatography can achieve a limit of sensitivity of 0.1 µg per wipe. Less than 1 µg of 2,3,7,8-TCDD per sample indicates acceptable cleanliness; anything higher warrants further cleaning. More than 10 µg on a wipe sample constitutes an acute hazard and requires prompt cleaning before further use of the equipment or work space. A high (>10 µg)

2,3,7,8-TCDD level indicates that unacceptable work practices have been employed in the past.

4.3.1.10 Inhalation—Any procedure that may produce airborne contamination must be done with good ventilation. Gross losses to a ventilation system must not be allowed. Handling of the dilute solutions normally used in analytical and animal work presents no inhalation hazards except in the case of an accident.

4.3.1.11 Accidents—Remove contaminated clothing immediately, taking precautions not to contaminate skin or other articles. Wash exposed skin vigorously and repeatedly until medical attention is obtained.

5. Apparatus and Materials

5.1 Sampling equipment, for discrete or composite sampling.

5.1.1 Grab sample bottle—1-L or 1-qt, amber glass, fitted with a screw cap lined with Teflon. Foil may be substituted for Teflon if the sample is not corrosive. If amber bottles are not available, protect samples from light. The bottle and cap liner must be washed, rinsed with acetone or methylene chloride, and dried before use to minimize contamination.

5.1.2 Automatic sampler (optional)—The sampler must incorporate glass sample containers for the collection of a minimum of 250 mL of sample. Sample containers must be kept refrigerated at 4 °C and protected from light during compositing. If the sampler uses a peristaltic pump, a minimum length of compressible silicone rubber tubing may be used. Before use, however, the compressible tubing should be thoroughly rinsed with methanol, followed by repeated rinsings with distilled water to minimize the potential for contamination of the sample. An integrating flow meter is required to collect flow proportional composites.

5.1.3 Clearly label all samples as “POISON” and ship according to U.S. Department of Transportation regulations.

5.2 Glassware (All specifications are suggested. Catalog numbers are included for illustration only.):

5.2.1 Separatory funnels—2-L and 125-mL, with Teflon stopcock.

5.2.2 Concentrator tube, Kuderna-Danish—10-mL, graduated (Kontes K-570050-1025 or equivalent). Calibration must be checked at the volumes employed in the test. Ground glass stopper is used to prevent evaporation of extracts.

5.2.3 Evaporative flask, Kuderna-Danish—500-mL (Kontes K-570001-0500 or equivalent). Attach to concentrator tube with springs.

5.2.4 Snyder column, Kuderna-Danish—Three-ball macro (Kontes K-503000-0121 or equivalent).

5.2.5 Snyder column, Kuderna-Danish—Two-ball micro (Kontes K-569001-0219 or equivalent).

5.2.6 Vials—10 to 15-mL, amber glass, with Teflon-lined screw cap.

5.2.7 Chromatographic column—300 mm long × 10 mm ID, with Teflon stopcock and coarse frit filter disc at bottom.

5.2.8 Chromatographic column—400 mm long × 11 mm ID, with Teflon stopcock and coarse frit filter disc at bottom.

5.3 Boiling chips—Approximately 10/40 mesh. Heat to 400 °C for 30 min or Soxhlet extract with methylene chloride.

5.4 Water bath—Heated, with concentric ring cover, capable of temperature control (± 2 °C). The bath should be used in a hood.

5.5 GC/MS system:

5.5.1 Gas chromatograph—An analytical system complete with a temperature programmable gas chromatograph and all required accessories including syringes, analytical columns, and gases. The injection port must be designed for capillary columns. Either split, splitless, or on-column injection techniques may be employed, as long as the requirements of Section 7.1.1 are achieved.

5.5.2 Column—60 m long × 0.25 mm ID glass or fused silica, coated with SP-2330 (or equivalent) with a film thickness of 0.2 μ m. Any equivalent column must resolve 2, 3, 7, 8-TCDD from the other 21 TCDD isomers.¹⁶

5.5.3 Mass spectrometer—Either a low resolution mass spectrometer (LRMS) or a high resolution mass spectrometer (HRMS) may be used. The mass spectrometer must be equipped with a 70 V (nominal) ion source and be capable of acquiring m/z abundance data in real time selected ion monitoring (SIM) for groups of four or more masses.

5.5.4 GC/MS interface—Any GC to MS interface can be used that achieves the requirements of Section 7.1.1. GC to MS interfaces constructed of all glass or glass-lined materials are recommended. Glass surfaces can be deactivated by silanizing with dichlorodimethylsilane. To achieve maximum sensitivity, the exit end of the capillary column should be placed in the ion source. A short piece of fused silica capillary can be used as the interface to overcome problems associated with straightening the exit end of glass capillary columns.

5.5.5 The SIM data acquired during the chromatographic program is defined as the Selected Ion Current Profile (SICP). The SICP can be acquired under computer control or as a real time analog output. If computer control is used, there must be software available to plot the SICP and report peak height or area data for any m/z in the SICP between specified time or scan number limits.

5.6 Balance—Analytical, capable of accurately weighing 0.0001 g.

6. Reagents

6.1 Reagent water—Reagent water is defined as a water in which an interferent is not observed at the MDL of 2, 3, 7, 8-TCDD.

Environmental Protection Agency

Pt. 136, App. A, Meth. 613

6.2 Sodium hydroxide solution (10 N)—Dissolve 40 g of NaOH (ACS) in reagent water and dilute to 100 mL. Wash the solution with methylene chloride and hexane before use.

6.3 Sodium thiosulfate—(ACS) Granular.

6.4 Sulfuric acid—Concentrated (ACS, sp. gr. 1.84).

6.5 Acetone, methylene chloride, hexane, benzene, ortho-xylene, tetradecane—Pesticide quality or equivalent.

6.6 Sodium sulfate—(ACS) Granular, anhydrous. Purify by heating at 400 °C for 4 h in a shallow tray.

6.7 Alumina—Neutral, 80/200 mesh (Fisher Scientific Co., No. A-540 or equivalent). Before use, activate for 24 h at 130 °C in a foil-covered glass container.

6.8 Silica gel—High purity grade, 100/120 mesh (Fisher Scientific Co., No. S-679 or equivalent).

6.9 Stock standard solutions (1.00 µg/µL)—Stock standard solutions can be prepared from pure standard materials or purchased as certified solutions. Acetone should be used as the solvent for spiking solutions; ortho-xylene is recommended for calibration standards for split injectors; and tetradecane is recommended for splitless or on-column injectors. Analyze stock internal standards to verify the absence of native 2,3,7,8-TCDD.

6.9.1 Prepare stock standard solutions of 2,3,7,8-TCDD (mol wt 320) and either ³⁷Cl₄ 2,3,7,8-TCDD (mol wt 328) or ¹³Cl₁₂ 2,3,7,8-TCDD (mol wt 332) in an isolated area by accurately weighing about 0.0100 g of pure material. Dissolve the material in pesticide quality solvent and dilute to volume in a 10-mL volumetric flask. When compound purity is assayed to be 96% or greater, the weight can be used without correction to calculate the concentration of the stock standard. Commercially prepared stock standards can be used at any concentration if they are certified by the manufacturer or by an independent source.

6.9.2 Transfer the stock standard solutions into Teflon-sealed screw-cap bottles. Store in an isolated refrigerator protected from light. Stock standard solutions should be checked frequently for signs of degradation or evaporation, especially just prior to preparing calibration standards or spiking solutions from them.

6.9.3 Stock standard solutions must be replaced after six months, or sooner if comparison with check standards indicates a problem.

6.10 Internal standard spiking solution (25 ng/mL)—Using stock standard solution, prepare a spiking solution in acetone of either ¹³Cl₁₂ or ³⁷Cl₄ 2,3,7,8-TCDD at a concentration of 25 ng/mL. (See Section 10.2)

6.11 Quality control check sample concentrate—See Section 8.2.1.

7. Calibration

7.1 Establish gas chromatographic operating conditions equivalent to those given in Table 1 and SIM conditions for the mass spectrometer as described in Section 12.2 The GC/MS system must be calibrated using the internal standard technique.

7.1.1 Using stock standards, prepare calibration standards that will allow measurement of relative response factors of at least three concentration ratios of 2,3,7,8-TCDD to internal standard. Each calibration standard must be prepared to contain the internal standard at a concentration of 25 ng/mL. If any interferences are contributed by the internal standard at m/z 320 and 322, its concentration may be reduced in the calibration standards and in the internal standard spiking solution (Section 6.10). One of the calibration standards should contain 2,3,7,8-TCDD at a concentration near, but above, the MDL and the other 2,3,7,8-TCDD concentrations should correspond to the expected range of concentrations found in real samples or should define the working range of the GC/MS system.

7.1.2 Using injections of 2 to 5 µL, analyze each calibration standard according to Section 12 and tabulate peak height or area response against the concentration of 2,3,7,8-TCDD and internal standard. Calculate response factors (RF) for 2,3,7,8-TCDD using Equation 1.

$$RF = \frac{(A_s)(C_{is})}{(A_{is})(C_s)}$$

Equation 1

where:

A_s=SIM response for 2,3,7,8-TCDD m/z 320.

A_{is}=SIM response for the internal standard, m/z 332 for ¹³Cl₁₂ 2,3,7,8-TCDD m/z 328 for ³⁷Cl₄ 2,3,7,8-TCDD.

C_{is}=Concentration of the internal standard (µg/L).

C_s=Concentration of 2,3,7,8-TCDD (µg/L).

If the RF value over the working range is a constant (<10% relative standard deviation, RSD), the RF can be assumed to be invariant and the average RF can be used for calculations. Alternatively, the results can be used to plot a calibration curve of response ratios, A_s/A_{is}, vs. RF.

7.1.3 The working calibration curve or RF must be verified on each working day by the measurement of one or more 2,3,7,8-TCDD calibration standards. If the response for 2,3,7,8-TCDD varies from the predicted response by more than ±15%, the test must be repeated using a fresh calibration standard. Alternatively, a new calibration curve must be prepared.

7.2 Before using any cleanup procedure, the analyst must process a series of calibration standards through the procedure to validate elution patterns and the absence of interferences from the reagents.

8. Quality Control

8.1 Each laboratory that uses this method is required to operate a formal quality control program. The minimum requirements of this program consist of an initial demonstration of laboratory capability and an ongoing analysis of spiked samples to evaluate and document data quality. The laboratory must maintain records to document the quality of data that is generated. Ongoing data quality checks are compared with established performance criteria to determine if the results of analyses meet the performance characteristics of the method. When results of sample spikes indicate atypical method performance, a quality control check standard must be analyzed to confirm that the measurements were performed in an in-control mode of operation.

8.1.1 The analyst must make an initial, one-time, demonstration of the ability to generate acceptable accuracy and precision with this method. This ability is established as described in Section 8.2.

8.1.2 In recognition of advances that are occurring in chromatography, the analyst is permitted certain options (detailed in Sections 10.5, 11.1, and 12.1) to improve the separations or lower the cost of measurements. Each time such a modification is made to the method, the analyst is required to repeat the procedure in Section 8.2

8.1.3 Before processing any samples, the analyst must analyze a reagent water blank to demonstrate that interferences from the analytical system and glassware are under control. Each time a set of samples is extracted or reagents are changed, a reagent water blank must be processed as a safeguard against laboratory contamination.

8.1.4 The laboratory must, on an ongoing basis, spike and analyze a minimum of 10% of all samples with native 2,3,7,8-TCDD to monitor and evaluate laboratory data quality. This procedure is described in Section 8.3.

8.1.5 The laboratory must, on an ongoing basis, demonstrate through the analyses of quality control check standards that the operation of the measurement system is in control. This procedure is described in Section 8.4. The frequency of the check standard analyses is equivalent to 10% of all samples analyzed but may be reduced if spike recoveries from samples (Section 8.3) meet all specified quality control criteria.

8.1.6 The laboratory must maintain performance records to document the quality of data that is generated. This procedure is described in Section 8.5.

8.2 To establish the ability to generate acceptable accuracy and precision, the analyst must perform the following operations.

8.2.1 A quality control (QC) check sample concentrate is required containing 2,3,7,8-TCDD at a concentration of 0.100 µg/mL in acetone. The QC check sample concentrate must be obtained from the U.S. Environmental Protection Agency, Environmental Monitoring and Support Laboratory in Cincinnati, Ohio, if available. If not available from that source, the QC check sample concentrate must be obtained from another external source. If not available from either source above, the QC check sample concentrate must be prepared by the laboratory using stock standards prepared independently from those used for calibration.

8.2.2 Using a pipet, prepare QC check samples at a concentration of 0.100 µg/L (100 ng/L) by adding 1.00 mL of QC check sample concentrate to each of four 1-L aliquots of reagent water.

8.2.3 Analyze the well-mixed QC check samples according to the method beginning in Section 10.

8.2.4 Calculate the average recovery (\bar{X}) in µg/L, and the standard deviation of the recovery (s) in µg/L, for 2,3,7,8-TCDD using the four results.

8.2.5 Compare s and (\bar{X}) with the corresponding acceptance criteria for precision and accuracy, respectively, found in Table 2. If s and \bar{X} meet the acceptance criteria, the system performance is acceptable and analysis of actual samples can begin. If s exceeds the precision limit or \bar{X} falls outside the range for accuracy, the system performance is unacceptable for 2,3,7,8-TCDD. Locate and correct the source of the problem and repeat the test beginning with Section 8.2.2.

8.3 The laboratory must, on an ongoing basis, spike at least 10% of the samples from each sample site being monitored to assess accuracy. For laboratories analyzing one to ten samples per month, at least one spiked sample per month is required.

8.3.1 The concentration of the spike in the sample should be determined as follows:

8.3.1.1 If, as in compliance monitoring, the concentration of 2,3,7,8-TCDD in the sample is being checked against a regulatory concentration limit, the spike should be at that limit or 1 to 5 times higher than the background concentration determined in Section 8.3.2, whichever concentration would be larger.

8.3.1.2 If the concentration of 2,3,7,8-TCDD in the sample is not being checked against a limit specific to that parameter, the spike should be at 0.100 µg/L or 1 to 5 times higher than the background concentration determined in Section 8.3.2, whichever concentration would be larger.

8.3.1.3 If it is impractical to determine background levels before spiking (e.g., maximum holding times will be exceeded), the

spike concentration should be (1) the regulatory concentration limit, if any; or, if none (2) the larger of either 5 times higher than the expected background concentration or 0.100 µg/L.

8.3.2 Analyze one sample aliquot to determine the background concentration (B) of 2,3,7,8-TCDD. If necessary, prepare a new QC check sample concentrate (Section 8.2.1) appropriate for the background concentration in the sample. Spike a second sample aliquot with 1.0 mL of the QC check sample concentrate and analyze it to determine the concentration after spiking (A) of 2,3,7,8-TCDD. Calculate percent recovery (P) as $100(A-B)/T$, where T is the known true value of the spike.

8.3.3 Compare the percent recovery (P) for 2,3,7,8-TCDD with the corresponding QC acceptance criteria found in Table 2. These acceptance criteria were calculated to include an allowance for error in measurement of both the background and spike concentrations, assuming a spike to background ratio of 5:1. This error will be accounted for to the extent that the analyst's spike to background ratio approaches 5:1.¹¹ If spiking was performed at a concentration lower than 0.100 µg/L, the analyst must use either the QC acceptance criteria in Table 2, or optional QC acceptance criteria calculated for the specific spike concentration. To calculate optional acceptance criteria for the recovery of 2,3,7,8-TCDD: (1) Calculate accuracy (X') using the equation in Table 3, substituting the spike concentration (T) for C; (2) calculate overall precision (S') using the equation in Table 3, substituting X' for X; (3) calculate the range for recovery at the spike concentration as $(100 X'/T) \pm 2.44(100 S'/T)\%$.¹¹

8.3.4 If the recovery of 2,3,7,8-TCDD falls outside the designated range for recovery, a check standard must be analyzed as described in Section 8.4.

8.4 If the recovery of 2,3,7,8-TCDD fails the acceptance criteria for recovery in Section 8.3, a QC check standard must be prepared and analyzed.

NOTE: The frequency for the required analysis of a QC check standard will depend upon the complexity of the sample matrix and the performance of the laboratory.

8.4.1 Prepare the QC check standard by adding 1.0 mL of QC check sample concentrate (Section 8.2.1 or 8.3.2) to 1 L of reagent water.

8.4.2 Analyze the QC check standard to determine the concentration measured (A) of 2,3,7,8-TCDD. Calculate the percent recovery (P_s) as $100(A/T)\%$, where T is the true value of the standard concentration.

8.4.3 Compare the percent recovery (P_s) with the corresponding QC acceptance criteria found in Table 2. If the recovery of 2,3,7,8-TCDD falls outside the designated range, the laboratory performance is judged to be out of control, and the problem must

be immediately identified and corrected. The analytical result for 2,3,7,8-TCDD in the unspiked sample is suspect and may not be reported for regulatory compliance purposes.

8.5 As part of the QC program for the laboratory, method accuracy for wastewater samples must be assessed and records must be maintained. After the analysis of five spiked wastewater samples as in Section 8.3, calculate the average percent recovery (P̄) and the standard deviation of the percent recovery (s_p). Express the accuracy assessment as a percent recovery interval from $\bar{P} - 2s_p$ to $\bar{P} + 2s_p$. If $\bar{P}=90\%$ and $s_p=10\%$, for example, the accuracy interval is expressed as 70–110%. Update the accuracy assessment on a regular basis (e.g. after each five to ten new accuracy measurements).

8.6 It is recommended that the laboratory adopt additional quality assurance practices for use with this method. The specific practices that are most productive depend upon the needs of the laboratory and the nature of the samples. Field duplicates may be analyzed to assess the precision of the environmental measurements. Whenever possible, the laboratory should analyze standard reference materials and participate in relevant performance evaluation studies.

9. Sample Collection, Preservation, and Handling

9.1 Grab samples must be collected in glass containers. Conventional sampling practices¹² should be followed, except that the bottle must not be prerinsed with sample before collection. Composite samples should be collected in refrigerated glass containers in accordance with the requirements of the program. Automatic sampling equipment must be as free as possible of Tygon tubing and other potential sources of contamination.

9.2 All samples must be iced or refrigerated at 4 °C and protected from light from the time of collection until extraction. Fill the sample bottles and, if residual chlorine is present, add 80 mg of sodium thiosulfate per liter of sample and mix well. EPA Methods 330.4 and 330.5 may be used for measurement of residual chlorine.¹³ Field test kits are available for this purpose.

9.3 Label all samples and containers "POISON" and ship according to applicable U.S. Department of Transportation regulations.

9.4 All samples must be extracted within 7 days of collection and completely analyzed within 40 days of extraction.²

10. Sample Extraction

CAUTION: When using this method to analyze for 2,3,7,8-TCDD, all of the following operations must be performed in a limited-access laboratory with the analyst wearing full

protective covering for all exposed skin surfaces. See Section 4.2.

10.1 Mark the water meniscus on the side of the sample bottle for later determination of sample volume. Pour the entire sample into a 2-L separatory funnel.

10.2 Add 1.00 mL of internal standard spiking solution to the sample in the separatory funnel. If the final extract will be concentrated to a fixed volume below 1.00 mL (Section 12.3), only that volume of spiking solution should be added to the sample so that the final extract will contain 25 ng/mL of internal standard at the time of analysis.

10.3 Add 60 mL of methylene chloride to the sample bottle, seal, and shake 30 s to rinse the inner surface. Transfer the solvent to the separatory funnel and extract the sample by shaking the funnel for 2 min. with periodic venting to release excess pressure. Allow the organic layer to separate from the water phase for a minimum of 10 min. If the emulsion interface between layers is more than one-third the volume of the solvent layer, the analyst must employ mechanical techniques to complete the phase separation. The optimum technique depends upon the sample, but may include stirring, filtration of the emulsion through glass wool, centrifugation, or other physical methods. Collect the methylene chloride extract in a 250-mL Erlenmeyer flask.

10.4 Add a second 60-mL volume of methylene chloride to the sample bottle and repeat the extraction procedure a second time, combining the extracts in the Erlenmeyer flask. Perform a third extraction in the same manner.

10.5 Assemble a Kuderna-Danish (K-D) concentrator by attaching a 10-mL concentrator tube to a 500-mL evaporative flask. Other concentration devices or techniques may be used in place of the K-D concentrator if the requirements of Section 8.2 are met.

10.6 Pour the combined extract into the K-D concentrator. Rinse the Erlenmeyer flask with 20 to 30 mL of methylene chloride to complete the quantitative transfer.

10.7 Add one or two clean boiling chips to the evaporative flask and attach a three-ball Snyder column. Prewet the Snyder column by adding about 1 mL of methylene chloride to the top. Place the K-D apparatus on a hot water bath (60 to 65 °C) so that the concentrator tube is partially immersed in the hot water, and the entire lower rounded surface of the flask is bathed with hot vapor. Adjust the vertical position of the apparatus and the water temperature as required to complete the concentration in 15 to 20 min. At the proper rate of distillation the balls of the column will actively chatter but the chambers will not flood with condensed solvent. When the apparent volume of liquid reaches 1 mL, remove the K-D apparatus and allow it to drain and cool for at least 10 min.

10.8 Momentarily remove the Snyder column, add 50 mL of hexane and a new boiling chip, and reattach the Snyder column. Raise the temperature of the water bath to 85 to 90°C. Concentrate the extract as in Section 10.7, except use hexane to prewet the column. Remove the Snyder column and rinse the flask and its lower joint into the concentrator tube with 1 to 2 mL of hexane. A 5-mL syringe is recommended for this operation. Set aside the K-D glassware for reuse in Section 10.14.

10.9 Pour the hexane extract from the concentrator tube into a 125-mL separatory funnel. Rinse the concentrator tube four times with 10-mL aliquots of hexane. Combine all rinses in the 125-mL separatory funnel.

10.10 Add 50 mL of sodium hydroxide solution to the funnel and shake for 30 to 60 s. Discard the aqueous phase.

10.11 Perform a second wash of the organic layer with 50 mL of reagent water. Discard the aqueous phase.

10.12 Wash the hexane layer with a least two 50-mL aliquots of concentrated sulfuric acid. Continue washing the hexane layer with 50-mL aliquots of concentrated sulfuric acid until the acid layer remains colorless. Discard all acid fractions.

10.13 Wash the hexane layer with two 50-mL aliquots of reagent water. Discard the aqueous phases.

10.14 Transfer the hexane extract into a 125-mL Erlenmeyer flask containing 1 to 2 g of anhydrous sodium sulfate. Swirl the flask for 30 s and decant the hexane extract into the reassembled K-D apparatus. Complete the quantitative transfer with two 10-mL hexane rinses of the Erlenmeyer flask.

10.15 Replace the one or two clean boiling chips and concentrate the extract to 6 to 10 mL as in Section 10.8.

10.16 Add a clean boiling chip to the concentrator tube and attach a two-ball micro-Snyder column. Prewet the column by adding about 1 mL of hexane to the top. Place the micro-K-D apparatus on the water bath so that the concentrator tube is partially immersed in the hot water. Adjust the vertical position of the apparatus and the water temperature as required to complete the concentration in 5 to 10 min. At the proper rate of distillation the balls of the column will actively chatter but the chambers will not flood. When the apparent volume of liquid reaches about 0.5 mL, remove the K-D apparatus and allow it to drain and cool for at least 10 min. Remove the micro-Snyder column and rinse its lower joint into the concentrator tube with 0.2 mL of hexane.

Adjust the extract volume to 1.0 mL with hexane. Stopper the concentrator tube and store refrigerated and protected from light if further processing will not be performed immediately. If the extract will be stored

longer than two days, it should be transferred to a Teflon-sealed screw-cap vial. If the sample extract requires no further cleanup, proceed with GC/MS analysis (Section 12). If the sample requires further cleanup, proceed to Section 11.

10.17 Determine the original sample volume by refilling the sample bottle to the mark and transferring the liquid to a 1000-mL graduated cylinder. Record the sample volume to the nearest 5 mL.

11. Cleanup and Separation

11.1 Cleanup procedures may not be necessary for a relatively clean sample matrix. If particular circumstances demand the use of a cleanup procedure, the analyst may use either procedure below or any other appropriate procedure.^{1,5M7} However, the analyst first must demonstrate that the requirements of Section 8.2 can be met using the method as revised to incorporate the cleanup procedure. Two cleanup column options are offered to the analyst in this section. The alumina column should be used first to overcome interferences. If background problems are still encountered, the silica gel column may be helpful.

11.2 Alumina column cleanup for 2,3,7,8-TCDD:

11.2.1 Fill a 300 mm long × 10 mm ID chromatographic column with activated alumina to the 150 mm level. Tap the column gently to settle the alumina and add 10 mm of anhydrous sodium sulfate to the top.

11.2.2 Preeelute the column with 50 mL of hexane. Adjust the elution rate to 1 mL/min. Discard the eluate and just prior to exposure of the sodium sulfate layer to the air, quantitatively transfer the 1.0-mL sample extract onto the column using two 2-mL portions of hexane to complete the transfer.

11.2.3 Just prior to exposure of the sodium sulfate layer to the air, add 50 mL of 3% methylene chloride/95% hexane (V/V) and continue the elution of the column. Discard the eluate.

11.2.4 Next, elute the column with 50 mL of 20% methylene chloride/80% hexane (V/V) into a 500-mL K-D flask equipped with a 10-mL concentrator tube. Concentrate the collected fraction to 1.0 mL as in Section 10.16 and analyze by GC/MS (Section 12).

11.3 Silica gel column cleanup for 2,3,7,8-TCDD:

11.3.1 Fill a 400 mm long × 11 mm ID chromatographic column with silica gel to the 300 mm level. Tap the column gently to settle the silica gel and add 10 mm of anhydrous sodium sulfate to the top.

11.3.2 Preeelute the column with 50 mL of 20% benzene/80% hexane (V/V). Adjust the elution rate to 1 mL/min. Discard the eluate and just prior to exposure of the sodium sulfate layer to the air, quantitatively transfer the 1.0-mL sample extract onto the column

using two 2-mL portions of 20% benzene/80% hexane to complete the transfer.

11.3.3 Just prior to exposure of the sodium sulfate layer to the air, add 40 mL of 20% benzene/80% hexane to the column. Collect the eluate in a clean 500-mL K-D flask equipped with a 10-mL concentrator tube. Concentrate the collected fraction to 1.0 mL as in Section 10.16 and analyze by GC/MS.

12. GC/MS Analysis

12.1 Table 1 summarizes the recommended operating conditions for the gas chromatograph. Included in this table are retention times and MDL that can be achieved under these conditions. Other capillary columns or chromatographic conditions may be used if the requirements of Sections 5.5.2 and 8.2 are met.

12.2 Analyze standards and samples with the mass spectrometer operating in the selected ion monitoring (SIM) mode using a dwell time to give at least seven points per peak. For LRMS, use masses at m/z 320, 322, and 257 for 2,3,7,8-TCDD and either m/z 328 for ³⁷Cl₄ 2,3,7,8-TCDD or m/z 332 for ¹³C₁₂ 2,3,7,8-TCDD. For HRMS, use masses at m/z 319.8965 and 321.8936 for 2,3,7,8-TCDD and either m/z 327.8847 for ³⁷Cl₄ 2,3,7,8-TCDD or m/z 331.9367 for ¹³C₁₂ 2,3,7,8-TCDD.

12.3 If lower detection limits are required, the extract may be carefully evaporated to dryness under a gentle stream of nitrogen with the concentrator tube in a water bath at about 40 °C. Conduct this operation immediately before GC/MS analysis. Redissolve the extract in the desired final volume of ortho-xylene or tetradecane.

12.4 Calibrate the system daily as described in Section 7.

12.5 Inject 2 to 5 µL of the sample extract into the gas chromatograph. The volume of calibration standard injected must be measured, or be the same as all sample injection volumes.

12.6 The presence of 2,3,7,8-TCDD is qualitatively confirmed if all of the following criteria are achieved:

12.6.1 The gas chromatographic column must resolve 2,3,7,8-TCDD from the other 21 TCDD isomers.

12.6.2 The masses for native 2,3,7,8-TCDD (LRMS-m/z 320, 322, and 257 and HRMS-m/z 320 and 322) and labeled 2,3,7,8-TCDD (m/z 328 or 332) must exhibit a simultaneous maximum at a retention time that matches that of native 2,3,7,8-TCDD in the calibration standard, with the performance specifications of the analytical system.

12.6.3 The chlorine isotope ratio at m/z 320 and m/z 322 must agree to within±10% of that in the calibration standard.

12.6.4 The signal of all peaks must be greater than 2.5 times the noise level.

12.7 For quantitation, measure the response of the m/z 320 peak for 2,3,7,8-TCDD

and the m/z 332 peak for $^{13}\text{C}_{12}$ 2,3,7,8-TCDD or the m/z 328 peak for $^{37}\text{Cl}_4$ 2,3,7,8-TCDD.

12.8 Co-eluting impurities are suspected if all criteria are achieved except those in Section 12.6.3. In this case, another SIM analysis using masses at m/z 257, 259, 320 and either m/z 328 or m/z 322 can be performed. The masses at m/z 257 and m/z 259 are indicative of the loss of one chlorine and one carbonyl group from 2,3,7,8-TCDD. If masses m/z 257 and m/z 259 give a chlorine isotope ratio that agrees to within $\pm 10\%$ of the same cluster in the calibration standards, then the presence of TCDD can be confirmed. Co-eluting DDD, DDE, and PCB residues can be confirmed, but will require another injection using the appropriate SIM masses or full repetitive mass scans. If the response for $^{37}\text{Cl}_4$ 2,3,7,8-TCDD at m/z 328 is too large, PCB contamination is suspected and can be confirmed by examining the response at both m/z 326 and m/z 328. The $^{37}\text{Cl}_4$ 2,3,7,8-TCDD internal standard gives negligible response at m/z 326. These pesticide residues can be removed using the alumina column cleanup procedure.

12.9 If broad background interference restricts the sensitivity of the GC/MS analysis, the analyst should employ additional cleanup procedures and reanalyze by GC/MS.

12.10 In those circumstances where these procedures do not yield a definitive conclusion, the use of high resolution mass spectrometry is suggested.⁵

13. Calculations

13.1 Calculate the concentration of 2,3,7,8-TCDD in the sample using the response factor (RF) determined in Section 7.1.2 and Equation 2.

$$\text{Concentration } (\mu\text{g/L}) = \frac{(A)(V_t)}{(V_i)(V_s)}$$

Equation 2

where:

A_s =SIM response for 2,3,7,8-TCDD at m/z 320.
 A_i =SIM response for the internal standard at m/z 328 or 332.

I_s =Amount of internal standard added to each extract (μg).

V_o =Volume of water extracted (L).

13.2 For each sample, calculate the percent recovery of the internal standard by comparing the area of the m/z peak measured in the sample to the area of the same peak in the calibration standard. If the recovery is below 50%, the analyst should review all aspects of his analytical technique.

13.3 Report results in $\mu\text{g/L}$ without correction for recovery data. All QC data obtained should be reported with the sample results.

14. Method Performance

14.1 The method detection limit (MDL) is defined as the minimum concentration of a substance that can be measured and reported with 99% confidence that the value is above zero.¹ The MDL concentration listed in Table 1 was obtained using reagent water.¹⁴ The MDL actually achieved in a given analysis will vary depending on instrument sensitivity and matrix effects.

14.2 This method was tested by 11 laboratories using reagent water, drinking water, surface water, and three industrial wastewaters spiked at six concentrations over the range 0.02 to 0.20 $\mu\text{g/L}$.¹⁵ Single operator precision, overall precision, and method accuracy were found to be directly related to the concentration of the parameter and essentially independent of the sample matrix. Linear equations to describe these relationships are presented in Table 3.

REFERENCES

- 40 CFR part 136, appendix B.
- "Determination of TCDD in Industrial and Municipal Wastewaters," EPA 600/4-82-028, National Technical Information Service, PB82-196882, Springfield, Virginia 22161, April 1982.
- Buser, H.R., and Rappe, C. "High Resolution Gas Chromatography of the 22 Tetrachlorodibenzo-p-dioxin Isomers," *Analytical Chemistry*, 52, 2257 (1980).
- ASTM Annual Book of Standards, Part 31, D3694-78. "Standard Practices for Preparation of Sample Containers and for Preservation of Organic Constituents," American Society for Testing and Materials, Philadelphia.
- Harless, R. L., Oswald, E. O., and Wilkinson, M. K. "Sample Preparation and Gas Chromatography/Mass Spectrometry Determination of 2,3,7,8-Tetrachlorodibenzo-p-dioxin," *Analytical Chemistry*, 52, 1239 (1980).
- Lamparski, L. L., and Nestruck, T. J. "Determination of Tetra-, Hepta-, and Octachlorodibenzo-p-dioxin Isomers in Particulate Samples at Parts per Trillion Levels," *Analytical Chemistry*, 52, 2045 (1980).
- Longhorst, M. L., and Shadoff, L. A. "Determination of Parts-per-Trillion Concentrations of Tetra-, Hexa-, and Octachlorodibenzo-p-dioxins in Human Milk," *Analytical Chemistry*, 52, 2037 (1980).
- "Carcinogens—Working with Carcinogens," Department of Health, Education, and Welfare, Public Health Service, Center for Disease Control, National Institute for Occupational Safety and Health, Publication No. 77-206, August 1977.
- "OSHA Safety and Health Standards, General Industry," (29 CFR part 1910), Occupational Safety and Health Administration, OSHA 2206 (Revised, January 1976).

Environmental Protection Agency

Pt. 136, App. A, Meth. 624

10. "Safety in Academic Chemistry Laboratories," American Chemical Society Publication, Committee on Chemical Safety, 3rd Edition, 1979.

11. Provost, L. P., and Elder, R. S., "Interpretation of Percent Recovery Data," *American Laboratory*, 15, 58-63 (1983). (The value 2.44 used in the equation in Section 8.3.3 is two times the value 1.22 derived in this report.)

12. ASTM Annual Book of Standards, Part 31, D3370-76, "Standard Practices for Sampling Water," American Society for Testing and Materials, Philadelphia.

13. "Methods, 330.4 (Titrimetric, DPD-FAS) and 330.5 (Spectrophotometric DPD) for Chlorine, Total Residual," Methods for Chemical Analysis of Water and Wastes, EPA-600/4-79-020, U.S. Environmental Protection Agency, Environmental Monitoring and Support Laboratory, Cincinnati, Ohio 45268, March 1979.

14. Wong, A.S. et al. "The Determination of 2,3,7,8-TCDD in Industrial and Municipal Wastewaters, Method 613, Part 1—Development and Detection Limits," G. Choudhay, L. Keith, and C. Ruppe, ed., Butterworth Inc., (1983).

15. "EPA Method Study 26, Method 613: 2,3,7,8-Tetrachlorodibenzo-p-dioxin," EPA 600/4-84-037, National Technical Information

Service, PB84-188879, Springfield, Virginia 22161, May 1984.

TABLE 1—CHROMATOGRAPHIC CONDITIONS AND METHOD DETECTION LIMIT

| Parameter | Retention time (min) | Method detection limit (µg/L) |
|--------------------|----------------------|-------------------------------|
| 2,3,7,8-TCDD | 13.1 | 0.002 |

Column conditions: SP-2330 coated on a 60 m long x 0.25 mm ID glass column with hydrogen carrier gas at 40 cm/sec linear velocity, splitless injection using tetradecane. Column temperature held isothermal at 200°C for 1 min, then programmed at 8°C/min to 250 °C and held. Use of helium carrier gas will approximately double the retention time.

TABLE 2—QC ACCEPTANCE CRITERIA—METHOD 613

| Parameter | Test conc. (µg/L) | Limit for s (µg/L) | Range for X (µg/L) | Range for P _s , P _s (%) |
|--------------|-------------------|--------------------|--------------------|---|
| 2,3,7,8-TCDD | 0.100 | 0.0276 | 0.0523-0.1226 | 45-129 |

s=Standard deviation of four recovery measurements, in µg/L (Section 8.2.4).

X=Average recovery for four recovery measurements, in µg/L (Section 8.2.4).

P_s, P_s=Percent recovery measured (Section 8.3.2, Section 8.4.2).

NOTE: These criteria are based directly upon the method performance data in Table 3. Where necessary, the limits for recovery have been broadened to assure applicability of the limits to concentrations below those used to develop Table 3.

TABLE 3—METHOD ACCURACY AND PRECISION AS FUNCTIONS OF CONCENTRATION—METHOD 613

| Parameter | Accuracy, as recovery, X' (µg/L) | Single analyst, precision, s' (µ/L) | Overall precision, S' (µg/L) |
|--------------------|----------------------------------|-------------------------------------|------------------------------|
| 2,3,7,8-TCDD | 0.86C+0.00145 | 0.13X̄+0.00129 | 0.19X̄+0.00028 |

X'=Expected recovery for one or more measurements, of a sample containing a concentration of C, in µg/L.
 s'=Expected single analyst standard deviation of measurements at an average concentration found of X̄, in µg/L.
 S'=Expected interlaboratory standard deviation of measurements at an average concentration found of X̄, in µg/L.
 C=True value for the concentration, in µg/L.
 X=Average recovery found for measurements of samples containing a concentration of C, in µg/L.

METHOD 624—PURGEABLES

1. Scope and Application

1.1 This method covers the determination of a number of purgeable organics. The following parameters may be determined by this method:

| Parameter | STORET No. | CAS No. |
|--------------------------------|------------|----------|
| Benzene | 34030 | 71-43-2 |
| Bromodichloromethane | 32101 | 75-27-4 |
| Bromofom | 32104 | 75-25-2 |
| Bromomethane | 34413 | 74-83-9 |
| Carbon tetrachloride | 32102 | 56-23-5 |
| Chlorobenzene | 34301 | 108-90-7 |
| Chloroethane | 34311 | 75-00-3 |
| 2-Chloroethylvinyl ether | 34576 | 110-75-8 |
| Chloroform | 32106 | 67-66-3 |
| Chloromethane | 34418 | 74-87-3 |
| Dibromochloromethane | 32105 | 124-48-1 |
| 1,2-Dichlorobenzene | 34536 | 95-50-1 |

| Parameter | STORET No. | CAS No. |
|---------------------------------|------------|------------|
| 1,3-Dichlorobenzene | 34566 | 541-73-1 |
| 1,4-Dichlorobenzene | 34571 | 106-46-7 |
| 1,1-Dichloroethane | 34496 | 75-34-3 |
| 1,2-Dichloroethane | 34531 | 107-06-2 |
| 1,1-Dichloroethane | 34501 | 75-35-4 |
| trans-1,2-Dichloroethene | 34546 | 156-60-5 |
| 1,2-Dichloropropane | 34541 | 78-87-5 |
| cis-1,3-Dichloropropene | 34704 | 10061-01-5 |
| trans-1,3-Dichloropropene | 34699 | 10061-02-6 |
| Ethyl benzene | 34371 | 100-41-4 |
| Methylene chloride | 34423 | 75-09-2 |
| 1,1,2,2-Tetrachloroethane | 34516 | 79-34-5 |
| Tetrachloroethene | 34475 | 127-18-4 |
| Toluene | 34010 | 108-88-3 |
| 1,1,1-Trichloroethene | 34506 | 71-55-6 |
| 1,1,2-Trichloroethene | 34511 | 79-00-5 |
| Trichloroethane | 39180 | 79-01-6 |
| Trichlorofluoromethane | 34488 | 75-69-4 |
| Vinyl chloride | 39175 | 75-01-4 |

1.2 The method may be extended to screen samples for acrolein (STORET No. 34210, CAS No. 107-02-8) and acrylonitrile (STORET No. 34215, CAS No. 107-13-1), however, the preferred method for these two compounds in Method 603.

1.3 This is a purge and trap gas chromatographic/mass spectrometer (GC/MS) method applicable to the determination of the compounds listed above in municipal and industrial discharges as provided under 40 CFR 136.1.

1.4 The method detection limit (MDL, defined in Section 14.1)¹ for each parameter is listed in Table 1. The MDL for a specific wastewater may differ from those listed, depending upon the nature of interferences in the sample matrix.

1.5 Any modification to this method, beyond those expressly permitted, shall be considered as a major modification subject to application and approval of alternate test procedures under 40 CFR 136.4 and 136.5. Depending upon the nature of the modification and the extent of intended use, the applicant may be required to demonstrate that the modifications will produce equivalent results when applied to relevant wastewaters.

1.6 This method is restricted to use by or under the supervision of analysts experienced in the operation of a purge and trap system and a gas chromatograph/mass spectrometer and in the interpretation of mass spectra. Each analyst must demonstrate the ability to generate acceptable results with this method using the procedure described in Section 8.2.

2. Summary of Method

2.1 An inert gas is bubbled through a 5-mL water sample contained in a specially-designed purging chamber at ambient temperature. The purgeables are efficiently transferred from the aqueous phase to the vapor phase. The vapor is swept through a sorbent trap where the purgeables are trapped. After purging is completed, the trap is heated and backflushed with the inert gas to desorb the purgeables onto a gas chromatographic column. The gas chromatograph is temperature programmed to separate the purgeables which are then detected with a mass spectrometer.^{2,3}

3. Interferences

3.1 Impurities in the purge gas, organic compounds outgassing from the plumbing ahead of the trap, and solvent vapors in the laboratory account for the majority of contamination problems. The analytical system must be demonstrated to be free from contamination under the conditions of the analysis by running laboratory reagent blanks as described in Section 8.1.3. The use of non-Teflon plastic tubing, non-Teflon thread sealants, or flow controllers with rubber

components in the purge and trap system should be avoided.

3.2 Samples can be contaminated by diffusion of volatile organics (particularly fluorocarbons and methylene chloride) through the septum seal into the sample during shipment and storage. A field reagent blank prepared from reagent water and carried through the sampling and handling protocol can serve as a check on such contamination.

3.3 Contamination by carry-over can occur whenever high level and low level samples are sequentially analyzed. To reduce carry-over, the purging device and sample syringe must be rinsed with reagent water between sample analyses. Whenever an unusually concentrated sample is encountered, it should be followed by an analysis of reagent water to check for cross contamination. For samples containing large amounts of water-soluble materials, suspended solids, high boiling compounds or high pureable levels, it may be necessary to wash the purging device with a detergent solution, rinse it with distilled water, and then dry it in a 105 °C oven between analyses. The trap and other parts of the system are also subject to contamination; therefore, frequent bakeout and purging of the entire system may be required.

4. Safety

4.1 The toxicity or carcinogenicity of each reagent used in this method has not been precisely defined; however, each chemical compound should be treated as a potential health hazard. From this viewpoint, exposure to these chemicals must be reduced to the lowest possible level by whatever means available. The laboratory is responsible for maintaining a current awareness file of OSHA regulations regarding the safe handling of the chemicals specified in this method. A reference file of material data handling sheets should also be made available to all personnel involved in the chemical analysis. Additional references to laboratory safety are available and have been identified^{4,6} for the information of the analyst.

4.2. The following parameters covered by this method have been tentatively classified as known or suspected, human or mammalian carcinogens: benzene, carbon tetrachloride, chloroform, 1,4-dichlorobenzene, and vinyl chloride. Primary standards of these toxic compounds should be prepared in a hood. A NIOSH/MESA approved toxic gas respirator should be worn when the analyst handles high concentrations of these toxic compounds.

5. Apparatus and Materials

5.1 Sampling equipment, for discrete sampling.

5.1.1 Vial—25-mL capacity or larger, equipped with a screw cap with a hole in the center (Pierce #13075 or equivalent). Detergent wash, rinse with tap and distilled water, and dry at 105 °C before use.

5.1.2 Septum—Teflon-faced silicane (Pierce #12722 or equivalent). Detergent wash, rinse with tap and distilled water, and dry at 105 °C for 1 h before use.

5.2 Purge and trap system—The purge and trap system consists of three separate pieces of equipment: A purging device, trap, and desorber. Several complete systems are now commercially available.

5.2.1 The purging device must be designed to accept 5-mL samples with a water column at least 3 cm deep. The gaseous head space between the water column and the trap must have a total volume of less than 15 mL. The purge gas must pass through the water column as finely divided bubbles with a diameter of less than 3 mm at the origin. The purge gas must be introduced no more than 5 mm from the base of the water column. The purging device illustrated in Figure 1 meets these design criteria.

5.2.2 The trap must be at least 25 cm long and have an inside diameter of at least 0.105 in. The trap must be packed to contain the following minimum lengths of adsorbents: 1.0 cm of methyl silicone coated packing (Section 6.3.2), 15 cm of 2,6-diphenylene oxide polymer (Section 6.3.1), and 8 cm of silica gel (Section 6.3.3). The minimum specifications for the trap are illustrated in Figure 2.

5.2.3 The desorber should be capable of rapidly heating the trap to 180 °C. The polymer section of the trap should not be heated higher than 180 °C and the remaining sections should not exceed 200 °C. The desorber illustrated in Figure 2 meets these design criteria.

5.2.4 The purge and trap system may be assembled as a separate unit or be coupled to a gas chromatograph as illustrated in Figures 3 and 4.

5.3 GC/MS system:

5.3.1 Gas chromatograph—An analytical system complete with a temperature programmable gas chromatograph suitable for on-column injection and all required accessories including syringes, analytical columns, and gases.

5.3.2 Column—6 ft long × 0.1 in ID stainless steel or glass, packed with 1% SP-1000 on Carbopack B (60/80 mesh) or equivalent. This column was used to develop the method performance statements in Section 14. Guidelines for the use of alternate column packings are provided in Section 11.1.

5.3.3 Mass spectrometer—Capable of scanning from 20 to 260 amu every 7 s or less, utilizing 70 V (nominal) electron energy in the electron impact ionization mode, and producing a mass spectrum which meets all the criteria in Table 2 when 50 ng of 4-

bromofluorobenzene (BFB) is injected through the GC inlet.

5.3.4 GC/MS interface—Any GC to MS interface that gives acceptable calibration points at 50 ng or less per injection for each of the parameters of interest and achieves all acceptable performance criteria (Section 10) may be used. GC to MS interfaces constructed of all glass or glass-lined materials are recommended. Glass can be deactivated by silanizing with dichlorodimethylsilane.

5.3.5 Data system—A computer system must be interfaced to the mass spectrometer that allows the continuous acquisition and storage on machine-readable media of all mass spectra obtained throughout the duration of the chromatographic program. The computer must have software that allows searching any GC/MS data file for specific m/z (masses) and plotting such m/z abundances versus time or scan number. This type of plot is defined as an Extracted Ion Current Profile (EICP). Software must also be available that allows integrating the abundance in any EICP between specified time or scan number limits.

5.4 Syringes—5-mL, glass hypodermic with Luerlok tip (two each), if applicable to the purging device.

5.5 Micro syringes—25- μ L, 0.006 in. ID needle.

5.6 Syringe valve—2-way, with Luer ends (three each).

5.7 Syringe—5-mL, gas-tight with shut-off valve.

5.8 Bottle—15-mL, screw-cap, with Teflon cap liner.

5.9 Balance—Analytical, capable of accurately weighing 0.0001 g.

6. Reagents

6.1 Reagent water—Reagent water is defined as a water in which an interferent is not observed at the MDL of the parameters of interest.

6.1.1 Reagent water can be generated by passing tap water through a carbon filter bed containing about 1 lb of activated carbon (Filtrisorb-300, Calgon Corp., or equivalent).

6.1.2 A water purification system (Millipore Super-Q or equivalent) may be used to generate reagent water.

6.1.3 Reagent water may also be prepared by boiling water for 15 min. Subsequently, while maintaining the temperature at 90 °C, bubble a contaminant-free inert gas through the water for 1 h. While still hot, transfer the water to a narrow mouth screw-cap bottle and seal with a Teflon-lined septum and cap.

6.2 Sodium thiosulfate—(ACS) Granular.

6.3 Trap materials:

6.3.1 2,6-Diphenylene oxide polymer—Tenax, (60/80 mesh), chromatographic grade or equivalent.

6.3.2 Methyl silicone packing—3% OV-1 on Chromosorb-W (60/80 mesh) or equivalent.

6.3.3 Silica gel—35/60 mesh, Davison, grade-15 or equivalent.

6.4 Methanol—Pesticide quality or equivalent.

6.5 Stock standard solutions—Stock standard solutions may be prepared from pure standard materials or purchased as certified solutions. Prepare stock standard solutions in methanol using assayed liquids or gases as appropriate. Because of the toxicity of some of the compounds, primary dilutions of these materials should be prepared in a hood. A NIOSH/MESA approved toxic gas respirator should be used when the analyst handles high concentrations of such materials.

6.5.1 Place about 9.8 mL of methanol into a 10-mL ground glass stoppered volumetric flask. Allow the flask to stand, unstoppered, for about 10 min or until all alcohol wetted surfaces have dried. Weigh the flask to the nearest 0.1 mg.

6.5.2 Add the assayed reference material:

6.5.2.1 Liquids—Using a 100- μ L syringe, immediately add two or more drops of assayed reference material to the flask, then reweigh. Be sure that the drops fall directly into the alcohol without contacting the neck of the flask.

6.5.2.2 Gases—To prepare standards for any of the four halocarbons that boil below 30 °C (bromomethane, chloroethane, chloromethane, and vinyl chloride), fill a 5-mL valved gas-tight syringe with the reference standard to the 5.0-mL mark. Lower the needle to 5 mm above the methanol meniscus. Slowly introduce the reference standard above the surface of the liquid (the heavy gas will rapidly dissolve in the methanol).

6.5.3 Reweigh, dilute to volume, stopper, then mix by inverting the flask several times. Calculate the concentration in μ g/ μ L from the net gain in weight. When compound purity is assayed to be 96% or greater, the weight may be used without correction to calculate the concentration of the stock standard. Commercially prepared stock standards may be used at any concentration if they are certified by the manufacturer or by an independent source.

6.5.4 Transfer the stock standard solution into a Teflon-sealed screw-cap bottle. Store, with minimal headspace, at -10 to -20 °C and protect from light.

6.5.5 Prepare fresh standards weekly for the four gases and 2-chloroethylvinyl ether. All other standards must be replaced after one month, or sooner if comparison with check standards indicates a problem.

6.6 Secondary dilution standards—Using stock solutions, prepare secondary dilution standards in methanol that contain the compounds of interest, either singly or mixed together. The secondary dilution standards should be prepared at concentrations such that the aqueous calibration standards prepared in Section 7.3 will bracket the working

range of the analytical system. Secondary dilution standards should be stored with minimal headspace and should be checked frequently for signs of degradation or evaporation, especially just prior to preparing calibration standards from them.

6.7 Surrogate standard spiking solution—Select a minimum of three surrogate compounds from Table 3. Prepare stock standard solutions for each surrogate standard in methanol as described in Section 6.5. Prepare a surrogate standard spiking solution from these stock standards at a concentration of 15 μ g/mL in water. Store the solutions at 4 °C in Teflon-sealed glass containers with a minimum of headspace. The solutions should be checked frequently for stability. The addition of 10 μ L of this solution of 5 mL of sample or standard is equivalent to a concentration of 30 μ g/L of each surrogate standard.

6.8 BFB Standard—Prepare a 25 μ g/mL solution of BFB in methanol.

6.9 Quality control check sample concentrate—See Section 8.2.1.

7. Calibration

7.1 Assemble a purge and trap system that meets the specifications in Section 5.2. Condition the trap overnight at 180 °C by backflushing with an inert gas flow of at least 20 mL/min. Condition the trap for 10 min once daily prior to use.

7.2 Connect the purge and trap system to a gas chromatograph. The gas chromatograph must be operated using temperature and flow rate conditions equivalent to those given in Table 1.

7.3 Internal standard calibration procedure—To use this approach, the analyst must select three or more internal standards that are similar in analytical behavior to the compounds of interest. The analyst must further demonstrate that the measurement of the internal standard is not affected by method or matrix interferences. Some recommended internal standards are listed in Table 3.

7.3.1 Prepare calibration standards at a minimum of three concentration levels for each parameter by carefully adding 20.0 μ L of one or more secondary dilution standards to 50, 250, or 500 mL of reagent water. A 25- μ L syringe with a 0.006 in. ID needle should be used for this operation. One of the calibration standards should be at a concentration near, but above, the MDL (Table 1) and the other concentrations should correspond to the expected range of concentrations found in real samples or should define the working range of the GC/MS system. These aqueous standards can be stored up to 24 h, if held in sealed vials with zero headspace as described in Section 9.2. If not so stored, they must be discarded after 1 h.

7.3.2 Prepare a spiking solution containing each of the internal standards using the procedures described in Sections 6.5 and

6.6. It is recommended that the secondary dilution standard be prepared at a concentration of 15 µg/mL of each internal standard compound. The addition of 10 µL of this standard to 5.0 mL of sample or calibration standard would be equivalent to 30 µg/L.

7.3.3 Analyze each calibration standard according to Section 11, adding 10 µL of internal standard spiking solution directly to the syringe (Section 11.4). Tabulate the area response of the characteristic m/z against concentration for each compound and internal standard, and calculate response factors (RF) for each compound using Equation 1.

$$RF = \frac{(A_s)(C_{is})}{(A_{is})(C_s)}$$

Equation 1

where:

A_s=Area of the characteristic m/z for the parameter to be measured.

A_{is}=Area of the characteristic m/z for the internal standard.

C_{is}=Concentration of the internal standard.

C_s=Concentration of the parameter to be measured.

If the RF value over the working range is a constant (<35% RSD), the RF can be assumed to be invariant and the average RF can be used for calculations. Alternatively, the results can be used to plot a calibration curve of response ratios, A_s/A_{is}, vs. RF.

7.4 The working calibration curve or RF must be verified on each working day by the measurement of a QC check sample.

7.4.1 Prepare the QC check sample as described in Section 8.2.2.

7.4.2 Analyze the QC check sample according to the method beginning in Section 10.

7.4.3 For each parameter, compare the response (Q) with the corresponding calibration acceptance criteria found in Table 5. If the responses for all parameters of interest fall within the designated ranges, analysis of actual samples can begin. If any individual Q falls outside the range, proceed according to Section 7.4.4.

NOTE: The large number of parameters in Table 5 present a substantial probability that one or more will not meet the calibration acceptance criteria when all parameters are analyzed.

7.4.4 Repeat the test only for those parameters that failed to meet the calibration acceptance criteria. If the response for a parameter does not fall within the range in this second test, a new calibration curve or RF must be prepared for that parameter according to Section 7.3.

8. Quality Control

8.1 Each laboratory that uses this method is required to operate a formal quality control program. The minimum requirements of

this program consist of an initial demonstration of laboratory capability and an ongoing analysis of spiked samples to evaluate and document data quality. The laboratory must maintain records to document the quality of data that is generated. Ongoing data quality checks are compared with established performance criteria to determine if the results of analyses meet the performance characteristics of the method. When results of sample spikes indicate atypical method performance, a quality control check standard must be analyzed to confirm that the measurements were performed in an in-control mode of operation.

8.1.1 The analyst must make an initial, one-time, demonstration of the ability to generate acceptable accuracy and precision with this method. This ability is established as described in Section 8.2.

8.1.2 In recognition of advances that are occurring in chromatography, the analyst is permitted certain options (detailed in Section 11.1) to improve the separations or lower the cost of measurements. Each time such a modification is made to the method, the analyst is required to repeat the procedure in Section 8.2.

8.1.3 Each day, the analyst must analyze a reagent water blank to demonstrate that interferences from the analytical system are under control.

8.1.4 The laboratory must, on an ongoing basis, spike and analyze a minimum of 5% of all samples to monitor and evaluate laboratory data quality. This procedure is described in Section 8.3.

8.1.5 The laboratory must, on an ongoing basis, demonstrate through the analyses of quality control check standards that the operation of the measurement system is in control. This procedure is described in Section 8.4. The frequency of the check standard analyses is equivalent to 5% of all samples analyzed but may be reduced if spike recoveries from samples (Section 8.3) meet all specified quality control criteria.

8.1.6 The laboratory must spike all samples with surrogate standards to monitor continuing laboratory performance. This procedure is described in Section 8.5.

8.1.7 The laboratory must maintain performance records to document the quality of data that is generated. This procedure is described in Section 8.6.

8.2 To establish the ability to generate acceptable accuracy and precision, the analyst must perform the following operations.

8.2.1 A quality control (QC) check sample concentrate is required containing each parameter of interest at a concentration of 10 µg/mL in methanol. The QC check sample concentrate must be obtained from the U.S. Environmental Protection Agency, Environmental Monitoring and Support Laboratory in Cincinnati, Ohio, if available. If not available from that source, the QC check sample

concentrate must be obtained from another external source. If not available from either source above, the QC check sample concentrate must be prepared by the laboratory using stock standards prepared independently from those used for calibration.

8.2.2 Prepare a QC check sample to contain 20 µg/L of each parameter by adding 200 µL of QC check sample concentrate to 100 mL of reagent water.

8.2.3 Analyze four 5-mL aliquots of the well-mixed QC check sample according to the method beginning in Section 10.

8.2.4 Calculate the average recovery (\bar{X}) in µg/L, and the standard deviation of the recovery (s) in µg/L, for each parameter of interest using the four results.

8.2.5 For each parameter compare s and \bar{X} with the corresponding acceptance criteria for precision and accuracy, respectively, found in Table 5. If s and \bar{X} for all parameters of interest meet the acceptance criteria, the system performance is acceptable and analysis of actual samples can begin. If any individual s exceeds the precision limit or any individual \bar{X} falls outside the range for accuracy, the system performance is unacceptable for that parameter.

NOTE: The large number of parameters in Table 5 present a substantial probability that one or more will fail at least one of the acceptance criteria when all parameters are analyzed.

8.2.6 When one or more of the parameters tested fail at least one of the acceptance criteria, the analyst must proceed according to Section 8.2.6.1 or 8.2.6.2.

8.2.6.1 Locate and correct the source of the problem and repeat the test for all parameters of interest beginning with Section 8.2.3.

8.2.6.2 Beginning with Section 8.2.3, repeat the test only for those parameters that failed to meet criteria. Repeated failure, however, will confirm a general problem with the measurement system. If this occurs, locate and correct the source of the problem and repeat the test for all compounds of interest beginning with Section 8.2.3.

8.3 The laboratory must, on an ongoing basis, spike at least 5% of the samples from each sample site being monitored to assess accuracy. For laboratories analyzing 1 to 20 samples per month, at least one spiked sample per month is required.

8.3.1 The concentration of the spike in the sample should be determined as follows:

8.3.1.1 If, as in compliance monitoring, the concentration of a specific parameter in the sample is being checked against a regulatory concentration limit, the spike should be at that limit or 1 to 5 times higher than the background concentration determined in Section 8.3.2, whichever concentration would be larger.

8.3.1.2 If the concentration of a specific parameter in the sample is not being

checked against a limit specific to that parameter, the spike should be at 20 µg/L or 1 to 5 times higher than the background concentration determined in Section 8.3.2, whichever concentration would be larger.

8.3.2 Analyze one 5-mL sample aliquot to determine the background concentration (B) of each parameter. If necessary, prepare a new QC check sample concentrate (Section 8.2.1) appropriate for the background concentrations in the sample. Spike a second 5-mL sample aliquot with 10 µL of the QC check sample concentrate and analyze it to determine the concentration after spiking (A) of each parameter. Calculate each percent recovery (P) as $100(A - B)\% / T$, where T is the known true value of the spike.

8.3.3 Compare the percent recovery (P) for each parameter with the corresponding QC acceptance criteria found in Table 5. These acceptance criteria were calculated to include an allowance for error in measurement of both the background and spike concentrations, assuming a spike to background ratio of 5:1. This error will be accounted for to the extent that the analyst's spike to background ratio approaches 5:1.⁷ If spiking was performed at a concentration lower than 20 µg/L, the analyst must use either the QC acceptance criteria in Table 5, or optional QC acceptance criteria calculated for the specific spike concentration. To calculate optional acceptance criteria for the recovery of a parameter: (1) Calculate accuracy (X') using the equation in Table 6, substituting the spike concentration (T) for C; (2) calculate overall precision (S') using the equation in Table 6, substituting X' for \bar{X} ; (3) calculate the range for recovery at the spike concentration as $(100 X' / T) (\pm 2.44(100 S' / T)\%)$.⁷

8.3.4 If any individual P falls outside the designated range for recovery, that parameter has failed the acceptance criteria. A check standard containing each parameter that failed the criteria must be analyzed as described in Section 8.4.

8.4 If any parameter fails the acceptance criteria for recovery in Section 8.3, a QC check standard containing each parameter that failed must be prepared and analyzed.

NOTE: The frequency for the required analysis of a QC check standard will depend upon the number of parameters being simultaneously tested, the complexity of the sample matrix, and the performance of the laboratory. If the entire list of parameters in Table 5 must be measured in the sample in Section 8.3, the probability that the analysis of a QC check standard will be required is high. In this case the QC check standard should be routinely analyzed with the spiked sample.

8.4.1 Prepare the QC check standard by adding 10 µL of QC check sample concentrate (Section 8.2.1 or 8.3.2) to 5 mL of reagent water. The QC check standard needs only to

contain the parameters that failed criteria in the test in Section 8.3.

8.4.2 Analyze the QC check standard to determine the concentration measured (A) of each parameter. Calculate each percent recovery (P_s) as $100(A/T)\%$, where T is the true value of the standard concentration.

8.4.3 Compare the percent recovery (P_s) for each parameter with the corresponding QC acceptance criteria found in Table 5. Only parameters that failed the test in Section 8.3 need to be compared with these criteria. If the recovery of any such parameter falls outside the designated range, the laboratory performance for that parameter is judged to be out of control, and the problem must be immediately identified and corrected. The analytical result for that parameter in the unspiked sample is suspect and may not be reported for regulatory compliance purposes.

8.5 As a quality control check, the laboratory must spike all samples with the surrogate standard spiking solutions as described in Section 11.4, and calculate the percent recovery of each surrogate compound.

8.6 As part of the QC program for the laboratory, method accuracy for wastewater samples must be assessed and records must be maintained. After the analysis of five spiked wastewater samples as in Section 8.3, calculate the average percent recovery (\bar{P}) and the standard deviation of the percent recovery (s_p). Express the accuracy assessment as a percent recovery interval from $\bar{P}-2s_p$ to $\bar{P}+2s_p$. If $\bar{P}=90\%$ and $s_p=10\%$, for example, the accuracy interval is expressed as 70–110%. Update the accuracy assessment for each parameter a regular basis (e.g. after each five to ten new accuracy measurements).

8.7 It is recommended that the laboratory adopt additional quality assurance practices for use with this method. The specific practices that are most productive depend upon the needs of the laboratory and the nature of the samples. Field duplicates may be analyzed to assess the precision of the environmental measurements. Whenever possible, the laboratory should analyze standard reference materials and participate in relevant performance evaluation studies.

9. Sample Collection, Preservation, and Handling

9.1 All samples must be iced or refrigerated from the time of collection until analysis. If the sample contains residual chlorine, add sodium thiosulfate preservative (10 mg/40 mL is sufficient for up to 5 ppm Cl_2) to the empty sample bottle just prior to shipping to the sampling site. EPA Methods 330.4 and 330.5 may be used for measurement of residual chlorine.⁸ Field test kits are available for this purpose.

9.2 Grab samples must be collected in glass containers having a total volume of at least 25 mL. Fill the sample bottle just to

overflowing in such a manner that no air bubbles pass through the sample as the bottle is being filled. Seal the bottle so that no air bubbles are entrapped in it. If preservative has been added, shake vigorously for 1 min. Maintain the hermetic seal on the sample bottle until time of analysis.

9.3 Experimental evidence indicates that some aromatic compounds, notably benzene, toluene, and ethyl benzene are susceptible to rapid biological degradation under certain environmental conditions.³ Refrigeration alone may not be adequate to preserve these compounds in wastewaters for more than seven days. For this reason, a separate sample should be collected, acidified, and analyzed when these aromatics are to be determined. Collect about 500 mL of sample in a clean container. Adjust the pH of the sample to about 2 by adding 1+1 HCl while stirring vigorously. Check pH with narrow range (1.4 to 2.8) pH paper. Fill a sample container as described in Section 9.2.

9.4 All samples must be analyzed within 14 days of collection.³

10. Daily GC/MS Performance Tests

10.1 At the beginning of each day that analyses are to be performed, the GC/MS system must be checked to see if acceptable performance criteria are achieved for BFB.⁹ The performance test must be passed before any samples, blanks, or standards are analyzed, unless the instrument has met the DFTTP test described in Method 625 earlier in the day.¹⁰

10.2 These performance tests require the following instrumental parameters:

Electron Energy: 70 V (nominal)

Mass Range: 20 to 260 amu

Scan Time: To give at least 5 scans per peak but not to exceed 7 s per scan.

10.3 At the beginning of each day, inject 2 μ L of BFB solution directly on the column. Alternatively, add 2 μ L of BFB solution to 5.0 mL of reagent water or standard solution and analyze the solution according to section 11. Obtain a background-corrected mass spectrum of BFB and confirm that all the key m/z criteria in Table 2 are achieved. If all the criteria are not achieved, the analyst must retune the mass spectrometer and repeat the test until all criteria are achieved.

11. Sample Purging and Gas Chromatography

11.1 Table 1 summarizes the recommended operating conditions for the gas chromatograph. Included in this table are retention times and MDL that can be achieved under these conditions. An example of the separations achieved by this column is shown in Figure 5. Other packed columns or chromatographic conditions may be used if the requirements of Section 8.2 are met.

11.2 After achieving the key m/z abundance criteria in Section 10, calibrate the system daily as described in Section 7.

11.3 Adjust the purge gas (helium) flow rate to 40 mL/min. Attach the trap inlet to the purging device, and set the purge and trap system to purge (Figure 3). Open the syringe valve located on the purging device sample introduction needle.

11.4 Allow the sample to come to ambient temperature prior to introducing it into the syringe. Remove the plunger from a 5-mL syringe and attach a closed syringe valve. Open the sample bottle (or standard) and carefully pour the sample into the syringe barrel to just short of overflowing. Replace the syringe plunger and compress the sample. Open the syringe valve and vent any residual air while adjusting the sample volume to 5.0 mL. Since this process of taking an aliquot destroys the validity of the sample for future analysis, the analyst should fill a second syringe at this time to protect against possible loss of data. Add 10.0 µL of the surrogate spiking solution (Section 6.7) and 10.0 µL of the internal standard spiking solution (Section 7.3.2) through the valve bore, then close the valve. The surrogate and internal standards may be mixed and added as a single spiking solution.

11.5 Attach the syringe-syringe valve assembly to the syringe valve on the purging device. Open the syringe valves and inject the sample into the purging chamber.

11.6 Close both valves and purge the sample for 11.0 ± 0.1 min at ambient temperature.

11.7 After the 11-min purge time, attach the trap to the chromatograph, adjust the purge and trap system to the desorb mode (Figure 4), and begin to temperature program the gas chromatograph. Introduce the trapped materials to the GC column by rapidly heating the trap to 180 °C while backflushing the trap with an inert gas between 20 and 60 mL/min for 4 min. If rapid heating of the trap cannot be achieved, the GC column must be used as a secondary trap by cooling it to 30 °C (subambient temperature, if problems persist) instead of the initial program temperature of 45 °C.

11.8 While the trap is being desorbed into the gas chromatograph, empty the purging chamber using the sample introduction syringe. Wash the chamber with two 5-mL flushes of reagent water.

11.9 After desorbing the sample for 4 min, recondition the trap by returning the purge and trap system to the purge mode. Wait 15 s then close the syringe valve on the purging device to begin gas flow through the trap. The trap temperature should be maintained at 180 °C. After approximately 7 min, turn off the trap heater and open the syringe valve to stop the gas flow through the trap. When the trap is cool, the next sample can be analyzed.

11.10 If the response for any m/z exceeds the working range of the system, prepare a dilution of the sample with reagent water from the aliquot in the second syringe and reanalyze.

12. Qualitative Identification

12.1 Obtain EICPs for the primary m/z (Table 4) and at least two secondary masses for each parameter of interest. The following criteria must be met to make a qualitative identification:

12.1.1 The characteristic masses of each parameter of interest must maximize in the same or within one scan of each other.

12.1.2 The retention time must fall within ±30 s of the retention time of the authentic compound.

12.1.3 The relative peak heights of the three characteristic masses in the EICPs must fall within ±20% of the relative intensities of these masses in a reference mass spectrum. The reference mass spectrum can be obtained from a standard analyzed in the GC/MS system or from a reference library.

12.2 Structural isomers that have very similar mass spectra and less than 30 s difference in retention time, can be explicitly identified only if the resolution between authentic isomers in a standard mix is acceptable. Acceptable resolution is achieved if the baseline to valley height between the isomers is less than 25% of the sum of the two peak heights. Otherwise, structural isomers are identified as isomeric pairs.

13. Calculations

13.1 When a parameter has been identified, the quantitation of that parameter should be based on the integrated abundance from the EICP of the primary characteristic m/z given in Table 4. If the sample produces an interference for the primary m/z, use a secondary characteristic m/z to quantitate.

Calculate the concentration in the sample using the response factor (RF) determined in Section 7.3.3 and Equation 2.

$$\text{Concentration } (\mu\text{g/L}) = \frac{(A_s)(C_{is})}{(A_{is})(RF)}$$

Equation 2

where:

A_s = Area of the characteristic m/z for the parameter or surrogate standard to be measured.

A_{is} = Area of the characteristic m/z for the internal standard.

C_{is} = Concentration of the internal standard.

13.2 Report results in µg/L without correction for recovery data. All QC data obtained should be reported with the sample results.

14. Method Performance

14.1 The method detection limit (MDL) is defined as the minimum concentration of a substance that can be measured and reported with 99% confidence that the value is above zero.¹ The MDL concentrations listed in Table 1 were obtained using reagent water.¹¹ Similar results were achieved using representative wastewaters. The MDL actually achieved in a given analysis will vary depending on instrument sensitivity and matrix effects.

14.2 This method was tested by 15 laboratories using reagent water, drinking water, surface water, and industrial wastewaters spiked at six concentrations over the range 5–600 µg/L.¹² Single operator precision, overall precision, and method accuracy were found to be directly related to the concentration of the parameter and essentially independent of the sample matrix. Linear equations to describe these relationships are presented in Table 5.

REFERENCES

- 40 CFR part 136, appendix B.
- Bellar, T.A., and Lichtenberg, J.J. "Determining Volatile Organics at Microgram-per-Litre Levels by Gas Chromatography," *Journal American Water Works Association*, 66, 739 (1974).
- Bellar, T.A., and Lichtenberg, J.J. "Semi-Automated Headspace Analysis of Drinking Waters and Industrial Waters for Purgeable Volatile Organic Compounds," *Measurement of Organic Pollutants in Water and Wastewater*, C.E. Van Hall, editor, American Society for Testing and Materials, Philadelphia, PA. Special Technical Publication 686, 1978.
- "Carcinogens—Working With Carcinogens," Department of Health, Education, and Welfare, Public Health Service, Center for Disease Control, National Institute for Occupational Safety and Health, Publication No. 77-206, August 1977.
- "OSHA Safety and Health Standards, General Industry," (29 CFR part 1910), Occupational Safety and Health Administration, OSHA 2206 (Revised, January 1976).
- "Safety in Academic Chemistry Laboratories," American Chemical Society Publication, Committee on Chemical Safety, 3rd Edition, 1979.
- Provost, L.P., and Elder, R.S. "Interpretation of Percent Recovery Data," *American Laboratory*, 15, 58–63 (1983). (The value 2.44 used in the equation in Section 8.2.3 is two times the value 1.22 derived in this report.)
- "Methods 330.4 (Titrimetric, DPD-FAS) and 330.5 (Spectrophotometric, DPD) for Chlorine, Total Residual," Methods for Chemical Analysis of Water and Wastes, EPA-600/4-79-020, U.S. Environmental Protection Agency, Environmental Monitoring

and Support Laboratory, Cincinnati, Ohio 45268, March 1979.

9. Budde, W.L., and Eichelberger, J.W. "Performance Tests for the Evaluation of Computerized Gas Chromatography/Mass Spectrometry Equipment and Laboratories," EPA-600/4-80-025, U.S. Environmental Protection Agency, Environmental Monitoring and Support Laboratory, Cincinnati, Ohio 45268, April 1980.

10. Eichelberger, J.W., Harris, L.E., and Budde, W.L. "Reference Compound to Calibrate Ion Abundance Measurement in Gas Chromatography—Mass Spectrometry Systems," *Analytical Chemistry*, 47, 995–1000 (1975).

11. "Method Detection Limit for Methods 624 and 625," Olynyk, P., Budde, W.L., and Eichelberger, J.W. Unpublished report, May 14, 1980.

12. "EPA Method Study 29 EPA Method 624—Purgeables," EPA 600/4-84-054, National Technical Information Service, PB84-209915, Springfield, Virginia 22161, June 1984.

13. "Method Performance Data for Method 624," Memorandum from R. Slater and T. Pressley, U.S. Environmental Protection Agency, Environmental Monitoring and Support Laboratory, Cincinnati, Ohio 45268, January 17, 1984.

TABLE 1—CHROMATOGRAPHIC CONDITIONS AND METHOD DETECTION LIMITS

| Parameter | Retention time (min) | Method detection limit (µg/L) |
|---------------------------------|----------------------|-------------------------------|
| Chloromethane | 2.3 | nd |
| Bromomethane | 3.1 | nd |
| Vinyl chloride | 3.8 | nd |
| Chloroethane | 4.6 | nd |
| Methylene chloride | 6.4 | 2.8 |
| Trichlorofluoromethane | 8.3 | nd |
| 1,1-Dichloroethene | 9.0 | 2.8 |
| 1,1-Dichloroethane | 10.1 | 4.7 |
| trans-1,2-Dichloroethene | 10.8 | 1.6 |
| Chloroform | 11.4 | 1.6 |
| 1,2-Dichloroethane | 12.1 | 2.8 |
| 1,1,1-Trichloroethane | 13.4 | 3.8 |
| Carbon tetrachloride | 13.7 | 2.8 |
| Bromodichloromethane | 14.3 | 2.2 |
| 1,2-Dichloropropane | 15.7 | 6.0 |
| cis-1,3-Dichloropropene | 15.9 | 5.0 |
| Trichloroethene | 16.5 | 1.9 |
| Benzene | 17.0 | 4.4 |
| Dibromochloromethane | 17.1 | 3.1 |
| 1,1,2-Trichloroethane | 17.2 | 5.0 |
| trans-1,3-Dichloropropene | 17.2 | nd |
| 2-Chloroethylvinyl ether | 18.6 | nd |
| Bromoform | 19.8 | 4.7 |
| 1,1,2,2-Tetrachloroethane | 22.1 | 6.9 |
| Tetrachloroethene | 22.2 | 4.1 |
| Toluene | 23.5 | 6.0 |
| Chlorobenzene | 24.6 | 6.0 |
| Ethyl benzene | 26.4 | 7.2 |
| 1,3-Dichlorobenzene | 33.9 | nd |
| 1,2-Dichlorobenzene | 35.0 | nd |

TABLE 1—CHROMATOGRAPHIC CONDITIONS AND METHOD DETECTION LIMITS—Continued

| Parameter | Retention time (min) | Method detection limit (µg/L) |
|---------------------------|----------------------|-------------------------------|
| 1,4-Dichlorobenzene | 35.4 | nd |

Column conditions: Carbowax B (60/80 mesh) coated with 1% SP-1000 packed in a 6 ft by 0.1 in. ID glass column with helium carrier gas at 30 mL/min. flow rate. Column temperature held at 45°C for 3 min., then programmed at 8°C/min. to 220°C and held for 15 min.
nd=not determined.

TABLE 2—BFB KEY M/Z ABUNDANCE CRITERIA

| Mass | m/z Abundance criteria |
|-----------|-------------------------------------|
| 50 | 15 to 40% of mass 95. |
| 75 | 30 to 60% of mass 95. |
| 95 | Base Peak, 100% Relative Abundance. |
| 96 | 5 to 9% of mass 95. |
| 173 | <2% of mass 174. |
| 174 | >50% of mass 95. |
| 175 | 5 to 9% of mass 174. |
| 176 | >95% but <101% of mass 174. |
| 177 | 5 to 9% of mass 176. |

TABLE 3—SUGGESTED SURROGATE AND INTERNAL STANDARDS

| Compound | Retention time (min) ^a | Primary m/z | Secondary masses |
|-------------------------------|-----------------------------------|-------------|------------------|
| Benzene d-6 | 17.0 | 84 | |
| 4-Bromofluorobenzene | 28.3 | 95 | 174, 176 |
| 1,2-Dichloroethane d-4 | 12.1 | 102 | |
| 1,4-Difluorobenzene | 19.6 | 114 | 63, 88 |
| Ethylbenzene d-5 | 26.4 | 111 | |
| Ethylbenzene d-10 | 26.4 | 98 | |
| Fluorobenzene | 18.4 | 96 | 70 |
| Pentafluorobenzene | 23.5 | 168 | |
| Bromochloromethane | 9.3 | 128 | 49, 130, 51 |
| 2-Bromo-1-chloropropane | 19.2 | 77 | 79, 156 |
| 1, 4-Dichlorobutane | 25.8 | 55 | 90, 92 |

^a For chromatographic conditions, see Table 1.

TABLE 4—CHARACTERISTIC MASSES FOR PURGEABLE ORGANICS

| Parameter | Primary | Secondary |
|---------------------------------|---------|-----------------------------------|
| Chloromethane | 50 | 52. |
| Bromomethane | 94 | 96. |
| Vinyl chloride | 62 | 64. |
| Chloroethane | 64 | 66. |
| Methylene chloride | 84 | 49, 51, and 86. |
| Trichlorofluoromethane | 101 | 103. |
| 1,1-Dichloroethene | 96 | 61 and 98. |
| 1,1-Dichloroethane | 63 | 65, 83, 85, 98, and 100. |
| trans-1,2-Dichloroethene | 96 | 61 and 98. |
| Chloroform | 83 | 85. |
| 1,2-Dichloroethane | 98 | 62, 64, and 100. |
| 1,1,1-Trichloroethane | 97 | 99, 117, and 119. |
| Carbon tetrachloride | 117 | 119 and 121. |
| Bromodichloromethane | 127 | 83, 85, and 129. |
| 1,2-Dichloropropane | 112 | 63, 65, and 114. |
| trans-1,3-Dichloropropene | 75 | 77. |
| Trichloroethene | 130 | 95, 97, and 132. |
| Benzene | 78 | |
| Dibromochloromethane | 127 | 129, 208, and 206. |
| 1,1,2-Trichloroethane | 97 | 83, 85, 99, 132, and 134. |
| cis-1,3-Dichloropropene | 75 | 77. |
| 2-Chloroethylvinyl ether | 106 | 63 and 65. |
| Bromoform | 173 | 171, 175, 250, 252, 254, and 256. |
| 1,1,2,2-Tetrachloroethane | 168 | 83, 85, 131, 133, and 166. |
| Tetrachloroethene | 164 | 129, 131, and 166. |
| Toluene | 92 | 91. |
| Chlorobenzene | 112 | 114. |
| Ethyl benzene | 106 | 91. |
| 1,3-Dichlorobenzene | 146 | 148 and 113. |
| 1,2-Dichlorobenzene | 146 | 148 and 113. |
| 1,4-Dichlorobenzene | 146 | 148 and 113. |

TABLE 5—CALIBRATION AND QC ACCEPTANCE CRITERIA—METHOD 624^A

| Parameter | Range for Q (µg/L) | Limit for s (µg/L) | Range for \bar{X} (µg/L) | Range for P, P _r (%) |
|--------------------------------|--------------------|--------------------|----------------------------|---------------------------------|
| Benzene | 12.8–27.2 | 6.9 | 15.2–26.0 | 37–151 |
| Bromodichloromethane | 13.1–26.9 | 6.4 | 10.1–28.0 | 35–155 |
| Bromoform | 14.2–25.8 | 5.4 | 11.4–31.1 | 45–169 |
| Bromomethane | 2.8–37.2 | 17.9 | D–41.2 | D–242 |
| Carbon tetrachloride | 14.6–25.4 | 5.2 | 17.2–23.5 | 70–140 |
| Chlorobenzene | 13.2–26.8 | 6.3 | 16.4–27.4 | 37–160 |
| Chloroethane | 7.6–32.4 | 11.4 | 8.4–40.4 | 14–230 |
| 2-Chloroethylvinyl ether | D–44.8 | 25.9 | D–50.4 | D–305 |
| Chloroform | 13.5–26.5 | 6.1 | 13.7–24.2 | 51–138 |
| Chloromethane | D–40.8 | 19.8 | D–45.9 | D–273 |
| Dibromochloromethane | 13.5–26.5 | 6.1 | 13.8–26.6 | 53–149 |
| 1,2-Dichlorobenzene | 12.6–27.4 | 7.1 | 11.8–34.7 | 18–190 |
| 1,3-Dichlorobenzene | 14.6–25.4 | 5.5 | 17.0–28.8 | 59–156 |
| 1,4-Dichlorobenzene | 12.6–27.4 | 7.1 | 11.8–34.7 | 18–190 |
| 1,1-Dichloroethane | 14.5–25.5 | 5.1 | 14.2–28.5 | 59–155 |
| 1,2-Dichloroethane | 13.6–26.4 | 6.0 | 14.3–27.4 | 49–155 |
| 1,1-Dichloroethene | 10.1–29.9 | 9.1 | 3.7–42.3 | D–234 |
| trans-1,2-Dichloroethene | 13.9–26.1 | 5.7 | 13.6–28.5 | 54–156 |

TABLE 5—CALIBRATION AND QC ACCEPTANCE CRITERIA—METHOD 624 ^A—Continued

| Parameter | Range for Q (µg/L) | Limit for s (µg/L) | Range for \bar{X} (µg/L) | Range for P, P _r (%) |
|---------------------------|-----------------------|-----------------------|-------------------------------|------------------------------------|
| 1,2-Dichloropropane | 6.8 – 33.2 | 13.8 | 3.8 – 36.2 | D – 210 |
| cis-1,3-Dichloropropene | 4.8 – 35.2 | 15.8 | 1.0 – 39.0 | D – 227 |
| trans-1,3-Dichloropropene | 10.0 – 30.0 | 10.4 | 7.6 – 32.4 | 17 – 183 |
| Ethyl benzene | 11.8 – 28.2 | 7.5 | 17.4 – 26.7 | 37 – 162 |
| Methylene chloride | 12.1 – 27.9 | 7.4 | D – 41.0 | D – 221 |
| 1,1,2,2-Tetrachloroethane | 12.1 – 27.9 | 7.4 | 13.5 – 27.2 | 46 – 157 |
| Tetrachloroethene | 14.7 – 25.3 | 5.0 | 17.0 – 26.6 | 64 – 148 |
| Toluene | 14.9 – 25.1 | 4.8 | 16.6 – 26.7 | 47 – 150 |
| 1,1,1-Trichloroethane | 15.0 – 25.0 | 4.6 | 13.7 – 30.1 | 52 – 162 |
| 1,1,2-Trichloroethane | 14.2 – 25.8 | 5.5 | 14.3 – 27.1 | 52 – 150 |
| Trichloroethene | 13.3 – 26.7 | 6.6 | 18.6 – 27.6 | 71 – 157 |
| Trichlorofluoromethane | 9.6 – 30.4 | 10.0 | 8.9 – 31.5 | 17 – 181 |
| Vinyl chloride | 0.8 – 39.2 | 20.0 | D – 43.5 | D – 251 |

Q= Concentration measured in QC check sample, in µg/L (Section 7.5.3).
 s= Standard deviation of four recovery measurements, in µg/L (Section 8.2.4).
 \bar{X} = Average recovery of four recovery measurements, in µg/L (Section 8.2.4).
 P, P_r= Percent recovery measured, (Section 8.3.2, Section 8.4.2).
 D= Detected; result must be greater than zero.
^a Criteria were calculated assuming a QC check sample concentration of 20 µg/L.

NOTE: These criteria are based directly upon the method performance data in Table 6. Where necessary, the limits for recovery have been broadened to assure applicability of the limits to concentrations below those used to develop Table 6.

TABLE 6—METHOD ACCURACY AND PRECISION AS FUNCTIONS OF CONCENTRATION—METHOD 624

| Parameter | Accuracy, as recovery, \bar{X} (µg/L) | Single analyst precision, S_r (µg/L) | Overall precision, S' (µg/L) |
|--|---|--|-----------------------------------|
| Benzene | 0.93C+2.00 | 0.26 \bar{X} – 1.74 | 0.25 \bar{X} – 1.33 |
| Bromodichloromethane | 1.03C – 1.58 | 0.15 \bar{X} +0.59 | 0.20 \bar{X} +1.13 |
| Bromoform | 1.18C – 2.35 | 0.12 \bar{X} +0.36 | 0.17 \bar{X} +1.38 |
| Bromomethane ^a | 1.00C | 0.43 \bar{X} | 0.58 \bar{X} |
| Carbon tetrachloride | 1.10C – 1.68 | 0.12 \bar{X} +0.25 | 0.11 \bar{X} +0.37 |
| Chlorobenzene | 0.98C+2.28 | 0.16 \bar{X} – 0.09 | 0.26 \bar{X} – 1.92 |
| Chloroethane | 1.18C+0.81 | 0.14 \bar{X} +2.78 | 0.29 \bar{X} +1.75 |
| 2-Chloroethylvinyl ether ^a | 1.00C | 0.62 \bar{X} | 0.84 \bar{X} |
| Chloroform | 0.93C+0.33 | 0.16 \bar{X} +0.22 | 0.18 \bar{X} +0.16 |
| Chloromethane | 1.03C+0.81 | 0.37 \bar{X} +2.14 | 0.58 \bar{X} +0.43 |
| Dibromochloromethane | 1.01C – 0.03 | 0.17 \bar{X} – 0.18 | 0.17 \bar{X} +0.49 |
| 1,2-Dichlorobenzene ^b | 0.94C+4.47 | 0.22 \bar{X} – 1.45 | 0.30 \bar{X} – 1.20 |
| 1,3-Dichlorobenzene | 1.06C+1.68 | 0.14 \bar{X} – 0.48 | 0.18 \bar{X} – 0.82 |
| 1,4-Dichlorobenzene ^b | 0.94C+4.47 | 0.22 \bar{X} – 1.45 | 0.30 \bar{X} – 1.20 |
| 1,1-Dichloroethane | 1.05C+0.36 | 0.13 \bar{X} – 0.05 | 0.16 \bar{X} +0.47 |
| 1,2-Dichloroethane | 1.02C+0.45 | 0.17 \bar{X} – 0.32 | 0.21 \bar{X} – 0.38 |
| 1,1-Dichloroethene | 1.12C+0.61 | 0.17 \bar{X} +1.06 | 0.43 \bar{X} – 0.22 |
| trans-1,2-Dichloroethene | 1.05C+0.03 | 0.14 \bar{X} +0.09 | 0.19 \bar{X} +0.17 |
| 1,2-Dichloropropane ^a | 1.00C | 0.33 \bar{X} | 0.45 \bar{X} |
| cis-1,3-Dichloropropene ^a | 1.00C | 0.38 \bar{X} | 0.52 \bar{X} |
| trans-1,3-Dichloropropene ^a | 1.00C | 0.25 \bar{X} | 0.34 \bar{X} |
| Ethyl benzene | 0.98C+2.48 | 0.14 \bar{X} +1.00 | 0.26 \bar{X} – 1.72 |
| Methylene chloride | 0.87C+1.88 | 0.15 \bar{X} +1.07 | 0.32 \bar{X} +4.00 |
| 1,1,2,2-Tetrachloroethane | 0.93C+1.76 | 0.16 \bar{X} +0.69 | 0.20 \bar{X} +0.41 |
| Tetrachloroethene | 1.06C+0.60 | 0.13 \bar{X} – 0.18 | 0.16 \bar{X} – 0.45 |
| Toluene | 0.98C+2.03 | 0.15 \bar{X} – 0.71 | 0.22 \bar{X} – 1.71 |
| 1,1,1-Trichloroethane | 1.06C+0.73 | 0.12 \bar{X} – 0.15 | 0.21 \bar{X} – 0.39 |
| 1,1,2-Trichloroethane | 0.95C+1.71 | 0.14 \bar{X} +0.02 | 0.18 \bar{X} +0.00 |
| Trichloroethene | 1.04C+2.27 | 0.13 \bar{X} +0.36 | 0.12 \bar{X} +0.59 |
| Trichlorofluoromethane | 0.99C+0.39 | 0.33 \bar{X} – 1.48 | 0.34 \bar{X} – 0.39 |
| Vinyl chloride | 1.00C | 0.48 \bar{X} | 0.65 \bar{X} |

\bar{X} =Expected recovery for one or more measurements of a sample containing a concentration of C, in µg/L.
 S_r =Expected single analyst standard deviation of measurements at an average concentration found of \bar{X} , in µg/L.
 S' =Expected interlaboratory standard deviation of measurements at an average concentration found of \bar{X} , in µg/L.
 C=True value for the concentration, in µg/L.
 \bar{X} =Average recovery found for measurements of samples containing a concentration of C, in µg/L.
^a Estimates based upon the performance in a single laboratory. ¹³
^b Due to chromatographic resolution problems, performance statements for these isomers are based upon the sums of their concentrations.

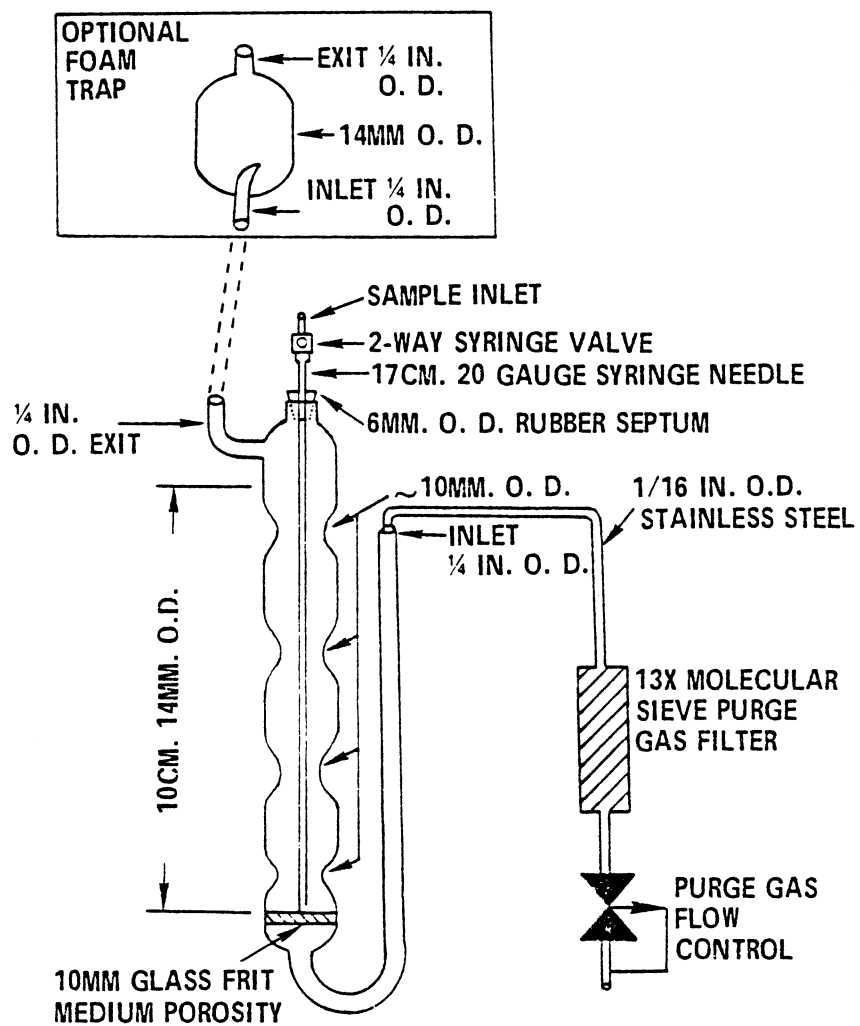

Figure 1. Purging device.

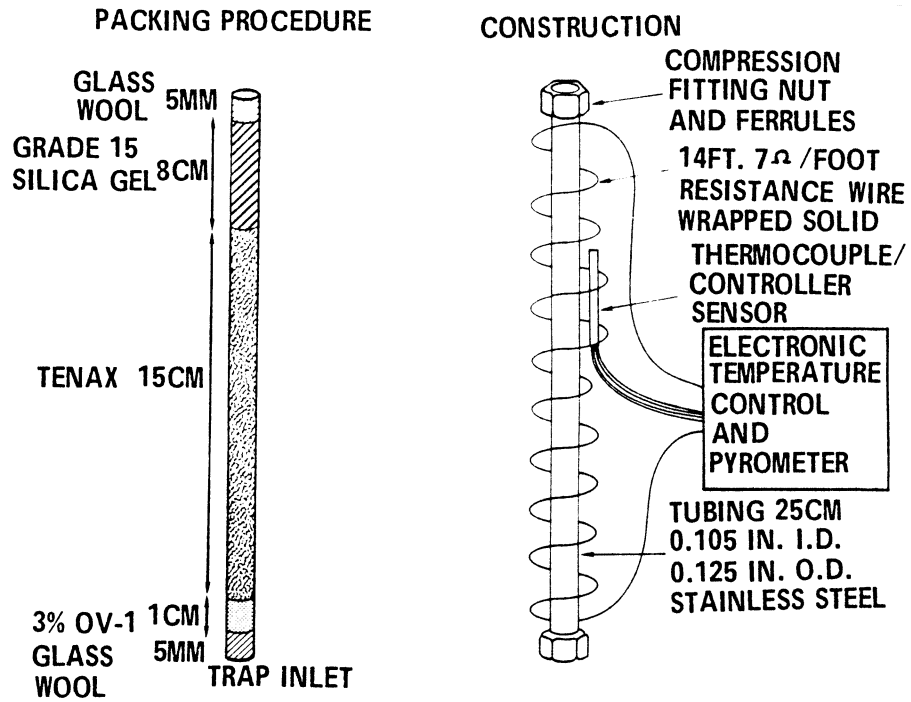

Figure 2. Trap packings and construction to include desorb capability.

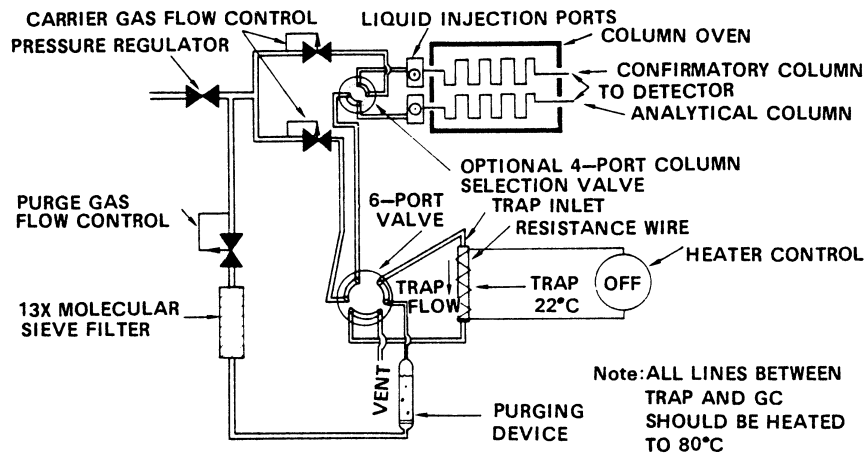

Figure 3. Purge and trap system - purge mode.

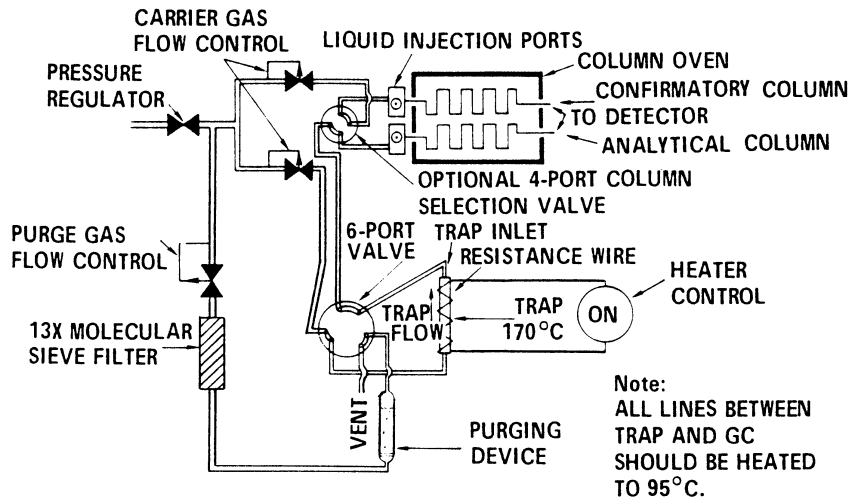

Figure 4. Purge and trap system - desorb mode.

COLUMN: 1% SP-1000 ON CARBOPACK-B
 PROGRAM: 45°C FOR 3 MIN, 8°C/MIN TO 220°C
 DETECTOR: MASS SPECTROMETER

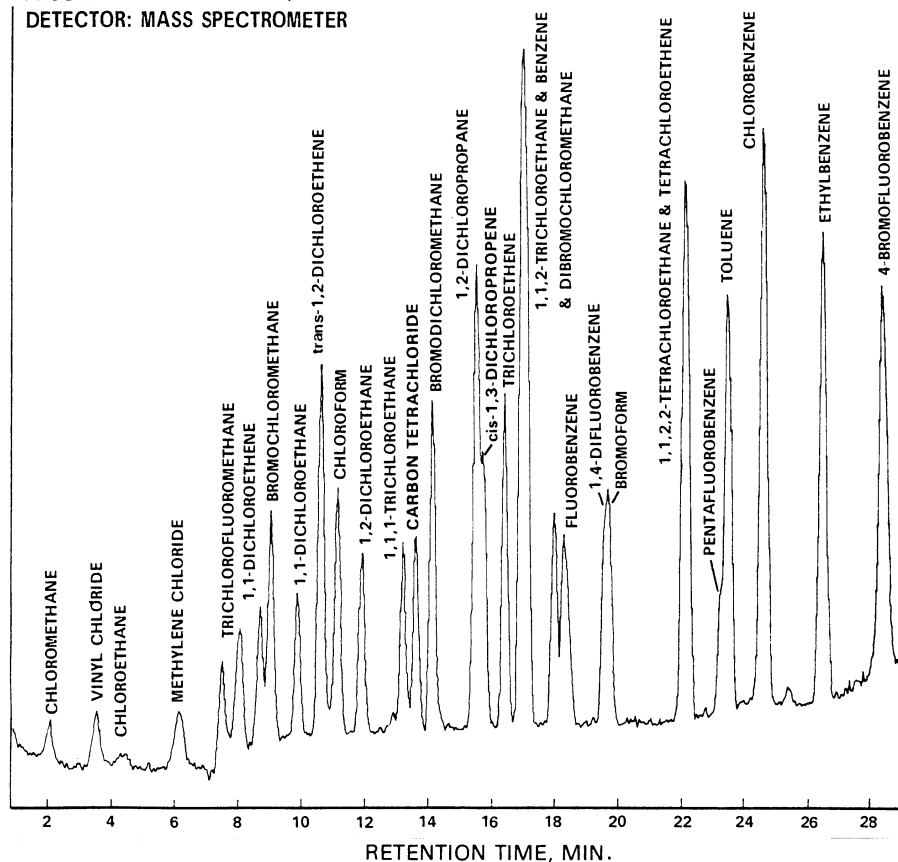

Figure 5. Gas chromatogram of volatile organics.

METHOD 625—BASE/NEUTRALS AND ACIDS

1. Scope and Application

1.1 This method covers the determination of a number of organic compounds that are partitioned into an organic solvent and are amenable to gas chromatography. The parameters listed in Tables 1 and 2 may be qualitatively and quantitatively determined using this method.

1.2 The method may be extended to include the parameters listed in Table 3. Benzidine can be subject to oxidative losses during solvent concentration. Under the alkaline conditions of the extraction step, α -BHC, γ -BHC, endosulfan I and II, and endrin are subject to decomposition.

Hexachlorocyclopentadiene is subject to thermal decomposition in the inlet of the gas chromatograph, chemical reaction in acetone solution, and photochemical decomposition. N-nitrosodimethylamine is difficult to separate from the solvent under the chromatographic conditions described. N-nitrosodiphenylamine decomposes in the gas chromatographic inlet and cannot be separated from diphenylamine. The preferred method for each of these parameters is listed in Table 3.

1.3 This is a gas chromatographic/mass spectrometry (GC/MS) method^{2,14} applicable to the determination of the compounds listed in Tables 1, 2, and 3 in municipal and industrial discharges as provided under 40 CFR 136.1.

1.4 The method detection limit (MDL, defined in Section 16.1)¹ for each parameter is listed in Tables 4 and 5. The MDL for a specific wastewater may differ from those listed, depending upon the nature of interferences in the sample matrix.

1.5 Any modification to this method, beyond those expressly permitted, shall be considered as a major modification subject to application and approval of alternate test procedures under 40 CFR 136.4 and 136.5. Depending upon the nature of the modification and the extent of intended use, the applicant may be required to demonstrate that the modifications will produce equivalent results when applied to relevant wastewaters.

1.6 This method is restricted to use by or under the supervision of analysts experienced in the use of a gas chromatograph/mass spectrometer and in the interpretation of mass spectra. Each analyst must demonstrate the ability to generate acceptable results with this method using the procedure described in Section 8.2.

2. Summary of Method

2.1 A measured volume of sample, approximately 1-L, is serially extracted with methylene chloride at a pH greater than 11 and again at a pH less than 2 using a separatory funnel or a continuous extractor.² The methylene chloride extract is dried, concentrated to a volume of 1 mL, and analyzed by GC/MS. Qualitative identification of the parameters in the extract is performed using the retention time and the relative abundance of three characteristic masses (m/z). Quantitative analysis is performed using internal standard techniques with a single characteristic m/z.

3. Interferences

3.1 Method interferences may be caused by contaminants in solvents, reagents, glassware, and other sample processing hardware that lead to discrete artifacts and/or elevated baselines in the total ion current profiles. All of these materials must be routinely demonstrated to be free from interferences under the conditions of the analysis by running laboratory reagent blanks as described in Section 8.1.3.

3.1.1 Glassware must be scrupulously cleaned.³ Clean all glassware as soon as possible after use by rinsing with the last solvent used in it. Solvent rinsing should be followed by detergent washing with hot water, and rinses with tap water and distilled water. The glassware should then be drained dry, and heated in a muffle furnace at 400 °C for 15 to 30 min. Some thermally stable materials, such as PCBs, may not be eliminated by this treatment. Solvent rinses with acetone and pesticide quality hexane may be substituted for the muffle furnace heating. Thorough rinsing with such solvents usually

eliminates PCB interference. Volumetric ware should not be heated in a muffle furnace. After drying and cooling, glassware should be sealed and stored in a clean environment to prevent any accumulation of dust or other contaminants. Store inverted or capped with aluminum foil.

3.1.2 The use of high purity reagents and solvents helps to minimize interference problems. Purification of solvents by distillation in all-glass systems may be required.

3.2 Matrix interferences may be caused by contaminants that are co-extracted from the sample. The extent of matrix interferences will vary considerably from source to source, depending upon the nature and diversity of the industrial complex or municipality being sampled.

3.3 The base-neutral extraction may cause significantly reduced recovery of phenol, 2-methylphenol, and 2,4-dimethylphenol. The analyst must recognize that results obtained under these conditions are minimum concentrations.

3.4 The packed gas chromatographic columns recommended for the basic fraction may not exhibit sufficient resolution for certain isomeric pairs including the following: anthracene and phenanthrene; chrysene and benzo(a)anthracene; and benzo(b)fluoranthene and benzo(k)fluoranthene. The gas chromatographic retention time and mass spectra for these pairs of compounds are not sufficiently different to make an unambiguous identification. Alternative techniques should be used to identify and quantify these specific compounds, such as Method 610.

3.5 In samples that contain an inordinate number of interferences, the use of chemical ionization (CI) mass spectrometry may make identification easier. Tables 6 and 7 give characteristic CI ions for most of the compounds covered by this method. The use of CI mass spectrometry to support electron ionization (EI) mass spectrometry is encouraged but not required.

4. Safety

4.1 The toxicity or carcinogenicity of each reagent used in this method have not been precisely defined; however, each chemical compound should be treated as a potential health hazard. From this viewpoint, exposure to these chemicals must be reduced to the lowest possible level by whatever means available. The laboratory is responsible for maintaining a current awareness file of OSHA regulations regarding the safe handling of the chemicals specified in this method. A reference file of material data handling sheets should also be made available to all personnel involved in the chemical analysis. Additional references to laboratory safety are available and have been identified⁴⁻⁶ for the information of the analyst.

4.2 The following parameters covered by this method have been tentatively classified as known or suspected, human or mammalian carcinogens: benzo(a)anthracene, benzidine, 3,3'-dichlorobenzidine, benzo(a)pyrene, α -BHC, β -BHC, δ -BHC, γ -BHC, dibenzo(a,h)anthracene, N-nitrosodimethylamine, 4,4'-DDT, and polychlorinated biphenyls (PCBs). Primary standards of these toxic compounds should be prepared in a hood. A NIOSH/MESA approved toxic gas respirator should be worn when the analyst handles high concentrations of these toxic compounds.

5. Apparatus and Materials

5.1 Sampling equipment, for discrete or composite sampling.

5.1.1 Grab sample bottle—1-L or 1-gt, amber glass, fitted with a screw cap lined with Teflon. Foil may be substituted for Teflon if the sample is not corrosive. If amber bottles are not available, protect samples from light. The bottle and cap liner must be washed, rinsed with acetone or methylene chloride, and dried before use to minimize contamination.

5.1.2 Automatic sampler (optional)—The sampler must incorporate glass sample containers for the collection of a minimum of 250 mL of sample. Sample containers must be kept refrigerated at 4 °C and protected from light during compositing. If the sampler uses a peristaltic pump, a minimum length of compressible silicone rubber tubing may be used. Before use, however, the compressible tubing should be thoroughly rinsed with methanol, followed by repeated rinsings with distilled water to minimize the potential for contamination of the sample. An integrating flow meter is required to collect flow proportional composites.

5.2 Glassware (All specifications are suggested. Catalog numbers are included for illustration only.):

5.2.1 Separatory funnel—2-L, with Teflon stopcock.

5.2.2 Drying column—Chromatographic column, 19 mm ID, with coarse frit

5.2.3 Concentrator tube, Kuderna-Danish—10-mL, graduated (Kontes K-570050-1025 or equivalent). Calibration must be checked at the volumes employed in the test. Ground glass stopper is used to prevent evaporation of extracts.

5.2.4 Evaporative flask, Kuderna-Danish—500-mL (Kontes K-57001-0500 or equivalent). Attach to concentrator tube with springs.

5.2.5 Snyder column, Kuderna-Danish—Three all macro (Kontes K-503000-0121 or equivalent).

5.2.6 Snyder column, Kuderna-Danish—Two-ball macro (Kontes K-569001-0219 or equivalent).

5.2.7 Vials—10 to 15-mL, amber glass, with Teflon-lined screw cap.

5.2.8 Continuous liquid—liquid extractor—Equipped with Teflon or glass connecting joints and stopcocks requiring no lubrication. (Hershberg-Wolf Extractor, Ace Glass Company, Vineland, N.J., P/N 6841-10 or equivalent.)

5.3 Boiling chips—Approximately 10/40 mesh. Heat to 400 °C for 30 min of Soxhlet extract with methylene chloride.

5.4 Water bath—Heated, with concentric ring cover, capable of temperature control ($\pm 2^\circ\text{C}$). The bath should be used in a hood.

5.5 Balance—Analytical, capable of accurately weighing 0.0001 g.

5.6 GC/MS system:

5.6.1 Gas Chromatograph—An analytical system complete with a temperature programmable gas chromatograph and all required accessories including syringes, analytical columns, and gases. The injection port must be designed for on-column injection when using packed columns and for splitless injection when using capillary columns.

5.6.2 Column for base/neutral—1.8 m long \times 2 mm ID glass, packed with 3% SP-2250 on Supelcoport (100/120 mesh) or equivalent. This column was used to develop the method performance statements in Section 16. Guidelines for the use of alternate column packings are provided in Section 13.1.

5.6.3 Column for acids—1.8 m long \times 2 mm ID glass, packed with 1% SP-1240DA on Supelcoport (100/120 mesh) or equivalent. This column was used to develop the method performance statements in Section 16. Guidelines for the use of alternate column packings are given in Section 13.1.

5.6.4 Mass spectrometer—Capable of scanning from 35 to 450 amu every 7 s or less, utilizing a 70 V (nominal) electron energy in the electron impact ionization mode, and producing a mass spectrum which meets all the criteria in Table 9 when 50 ng of decafluorotriphenyl phosphine (DFTTP; bis(perfluorophenyl) phenyl phosphine) is injected through the GC inlet.

5.6.5 GC/MS interface—Any GC to MS interface that gives acceptable calibration points at 50 ng per injection for each of the parameters of interest and achieves all acceptable performance criteria (Section 12) may be used. GC to MS interfaces constructed of all glass or glass-lined materials are recommended. Glass can be deactivated by silanizing with dichlorodimethylsilane.

5.6.6 Data system—A computer system must be interfaced to the mass spectrometer that allows the continuous acquisition and storage on machine-readable media of all mass spectra obtained throughout the duration of the chromatographic program. The computer must have software that allows searching any GC/MS data file for specific m/z and plotting such m/z abundances versus time or scan number. This type of plot is defined as an Extracted Ion Current Profile (EICP). Software must also be available that

allows integrating the abundance in any EICP between specified time or scan number limits.

6. Reagents

6.1 Reagent water—Reagent water is defined as a water in which an interferent is not observed at the MDL of the parameters of interest.

6.2 Sodium hydroxide solution (10 N)—Dissolve 40 g of NaOH (ACS) in reagent water and dilute to 100 mL.

6.3 Sodium thiosulfate—(ACS) Granular.

6.4 Sulfuric acid (1+1)—Slowly, add 50 mL of H₂SO₄ (ACS, sp. gr. 1.84) to 50 mL of reagent water.

6.5 Acetone, methanol, methylene chloride—Pesticide quality or equivalent.

6.6 Sodium sulfate—(ACS) Granular, anhydrous. Purify by heating at 400 °C for 4 h in a shallow tray.

6.7 Stock standard solutions (1.00 µg/µL)—standard solutions can be prepared from pure standard materials or purchased as certified solutions.

6.7.1 Prepare stock standard solutions by accurately weighing about 0.0100 g of pure material. Dissolve the material in pesticide quality acetone or other suitable solvent and dilute to volume in a 10-mL volumetric flask. Larger volumes can be used at the convenience of the analyst. When compound purity is assayed to be 96% or greater, the weight may be used without correction to calculate the concentration of the stock standard. Commercially prepared stock standards may be used at any concentration if they are certified by the manufacturer or by an independent source.

6.7.2 Transfer the stock standard solutions into Teflon-sealed screw-cap bottles. Store at 4 °C and protect from light. Stock standard solutions should be checked frequently for signs of degradation or evaporation, especially just prior to preparing calibration standards from them.

6.7.3 Stock standard solutions must be replaced after six months, or sooner if comparison with quality control check samples indicate a problem.

6.8 Surrogate standard spiking solution—Select a minimum of three surrogate compounds from Table 8. Prepare a surrogate standard spiking solution containing each selected surrogate compound at a concentration of 100 µg/mL in acetone. Addition of 1.00 mL of this solution to 1000 mL of sample is equivalent to a concentration of 100 µg/L of each surrogate standard. Store the spiking solution at 4 °C in Teflon-sealed glass container. The solution should be checked frequently for stability. The solution must be replaced after six months, or sooner if comparison with quality control check standards indicates a problem.

6.9 DFTPP standard—Prepare a 25 µg/mL solution of DFTPP in acetone.

6.10 Quality control check sample concentrate—See Section 8.2.1.

7. Calibration

7.1 Establish gas chromatographic operating parameters equivalent to those indicated in Table 4 or 5.

7.2 Internal standard calibration procedure—To use this approach, the analyst must select three or more internal standards that are similar in analytical behavior to the compounds of interest. The analyst must further demonstrate that the measurement of the internal standards is not affected by method or matrix interferences. Some recommended internal standards are listed in Table 8. Use the base peak m/z as the primary m/z for quantification of the standards. If interferences are noted, use one of the next two most intense m/z quantities for quantification.

7.2.1 Prepare calibration standards at a minimum of three concentration levels for each parameter of interest by adding appropriate volumes of one or more stock standards to a volumetric flask. To each calibration standard or standard mixture, add a known constant amount of one or more internal standards, and dilute to volume with acetone. One of the calibration standards should be at a concentration near, but above, the MDL and the other concentrations should correspond to the expected range of concentrations found in real samples or should define the working range of the GC/MS system.

7.2.2 Using injections of 2 to 5 µL, analyze each calibration standard according to Section 13 and tabulate the area of the primary characteristic m/z (Tables 4 and 5) against concentration for each compound and internal standard. Calculate response factors (RF) for each compound using Equation 1.

$$RF = \frac{(A_s)(C_{is})}{(A_{is})(C_s)}$$

Equation 1

where:

A_s=Area of the characteristic m/z for the parameter to be measured.

A_{is}=Area of the characteristic m/z for the internal standard.

C_{is}=Concentration of the internal standard (µg/L).

C_s=Concentration of the parameter to be measured (µg/L).

If the RF value over the working range is a constant (<35% RSD), the RF can be assumed to be invariant and the average RF can be used for calculations. Alternatively, the results can be used to plot a calibration curve of response ratios, A_s/A_{is}, vs. RF.

7.3 The working calibration curve or RF must be verified on each working day by the

measurement of one or more calibration standards. If the response for any parameter varies from the predicted response by more than $\pm 20\%$, the test must be repeated using a fresh calibration standard. Alternatively, a new calibration curve must be prepared for that compound.

8. Quality Control

8.1 Each laboratory that uses this method is required to operate a formal quality control program. The minimum requirements of this program consist of an initial demonstration of laboratory capability and an ongoing analysis of spiked samples to evaluate and document data quality. The laboratory must maintain records to document the quality of data that is generated. Ongoing data quality checks are compared with established performance criteria to determine if the results of analyses meet the performance characteristics of the method. When results of sample spikes indicate atypical method performance, a quality control check standard must be analyzed to confirm that the measurements were performed in an in-control mode of operation.

8.1.1 The analyst must make an initial, one-time, demonstration of the ability to generate acceptable accuracy and precision with this method. This ability is established as described in Section 8.2.

8.1.2 In recognition of advances that are occurring in chromatography, the analyst is permitted certain options (detailed in Sections 10.6 and 13.1) to improve the separations or lower the cost of measurements. Each time such a modification is made to the method, the analyst is required to repeat the procedure in Section 8.2.

8.1.3 Before processing any samples, the analyst must analyze a reagent water blank to demonstrate that interferences from the analytical system and glassware are under control. Each time a set of samples is extracted or reagents are changed, a reagent water blank must be processed as a safeguard against laboratory contamination.

8.1.4 The laboratory must, on an ongoing basis, spike and analyze a minimum of 5% of all samples to monitor and evaluate laboratory data quality. This procedure is described in Section 8.3.

8.1.5 The laboratory must, on an ongoing basis, demonstrate through the analyses of quality control check standards that the operation of the measurement system is in control. This procedure is described in Section 8.4. The frequency of the check standard analyses is equivalent to 5% of all samples analyzed but may be reduced if spike recoveries from samples (Section 8.3) meet all specified quality control criteria.

8.1.6 The laboratory must maintain performance records to document the quality of data that is generated. This procedure is described in Section 8.5.

8.2 To establish the ability to generate acceptable accuracy and precision, the analyst must perform the following operations.

8.2.1 A quality control (QC) check sample concentrate is required containing each parameter of interest at a concentration of 100 $\mu\text{g/mL}$ in acetone. Multiple solutions may be required. PCBs and multicomponent pesticides may be omitted from this test. The QC check sample concentrate must be obtained from the U.S. Environmental Protection Agency, Environmental Monitoring and Support Laboratory in Cincinnati, Ohio, if available. If not available from that source, the QC check sample concentrate must be obtained from another external source. If not available from either source above, the QC check sample concentrate must be prepared by the laboratory using stock standards prepared independently from those used for calibration.

8.2.2 Using a pipet, prepare QC check samples at a concentration of 100 $\mu\text{g/L}$ by adding 1.00 mL of QC check sample concentrate to each of four 1-L aliquots of reagent water.

8.2.3 Analyze the well-mixed QC check samples according to the method beginning in Section 10 or 11.

8.2.4 Calculate the average recovery (X) in $\mu\text{g/L}$, and the standard deviation of the recovery (s) in $\mu\text{g/L}$, for each parameter using the four results.

8.2.5 For each parameter compare s and X with the corresponding acceptance criteria for precision and accuracy, respectively, found in Table 6. If s and X for all parameters of interest meet the acceptance criteria, the system performance is acceptable and analysis of actual samples can begin. If any individual s exceeds the precision limit or any individual X falls outside the range for accuracy, the system performance is unacceptable for that parameter.

NOTE: The large number of parameters in Table 6 present a substantial probability that one or more will fail at least one of the acceptance criteria when all parameters are analyzed.

8.2.6 When one or more of the parameters tested fail at least one of the acceptance criteria, the analyst must proceed according to Section 8.2.6.1 or 8.2.6.2.

8.2.6.1 Locate and correct the source of the problem and repeat the test for all parameters of interest beginning with Section 8.2.2.

8.2.6.2 Beginning with Section 8.2.2, repeat the test only for those parameters that failed to meet criteria. Repeated failure, however, will confirm a general problem with the measurement system. If this occurs, locate and correct the source of the problem and repeat the test for all compounds of interest beginning with Section 8.2.2.

8.3 The laboratory must, on an ongoing basis, spike at least 5% of the samples from each sample site being monitored to assess

accuracy. For laboratories analyzing 1 to 20 samples per month, at least one spiked sample per month is required.

8.3.1. The concentration of the spike in the sample should be determined as follows:

8.3.1.1 If, as in compliance monitoring, the concentration of a specific parameter in the sample is being checked against a regulatory concentration limit, the spike should be at that limit or 1 to 5 times higher than the background concentration determined in Section 8.3.2, whichever concentration would be larger.

8.3.1.2 If the concentration of a specific parameter in the sample is not being checked against a limit specific to that parameter, the spike should be at 100 µg/L or 1 to 5 times higher than the background concentration determined in Section 8.3.2, whichever concentration would be larger.

8.3.1.3 If it is impractical to determine background levels before spiking (e.g., maximum holding times will be exceeded), the spike concentration should be (1) the regulatory concentration limit, if any; or, if none (2) the larger of either 5 times higher than the expected background concentration or 100 µg/L.

8.3.2 Analyze one sample aliquot to determine the background concentration (B) of each parameter. If necessary, prepare a new QC check sample concentrate (Section 8.2.1) appropriate for the background concentrations in the sample. Spike a second sample aliquot with 1.0 mL of the QC check sample concentrate and analyze it to determine the concentration after spiking (A) of each parameter. Calculate each percent recovery (P) as $100(A-B)/T$, where T is the known true value of the spike.

8.3.3 Compare the percent recovery (P) for each parameter with the corresponding QC acceptance criteria found in Table 6. These acceptance criteria were calculated to include an allowance for error in measurement of both the background and spike concentrations, assuming a spike to background ratio of 5:1. This error will be accounted for to the extent that the analyst's spike to background ratio approaches 5:1.⁷ If spiking was performed at a concentration lower than 100 µg/L, the analyst must use either the QC acceptance criteria in Table 6, or optional QC acceptance criteria calculated for the specific spike concentration. To calculate optional acceptance criteria for the recovery of a parameter: (1) Calculate accuracy (X') using the equation in Table 7, substituting the spike concentration (T) for C; (2) calculate overall precision (S') using the equation in Table 7, substituting X' for X; (3) calculate the range for recovery at the spike concentration as $(100 X'/T) \pm 2.44(100 S'/T)\%$ ⁷

8.3.4 If any individual P falls outside the designated range for recovery, that parameter has failed the acceptance criteria. A check standard containing each parameter

that failed the criteria must be analyzed as described in Section 8.4.

8.4 If any parameter fails the acceptance criteria for recovery in Section 8.3, a QC check standard containing each parameter that failed must be prepared and analyzed.

NOTE: The frequency for the required analysis of a QC check standard will depend upon the number of parameters being simultaneously tested, the complexity of the sample matrix, and the performance of the laboratory. If the entire list of single-component parameters in Table 6 must be measured in the sample in Section 8.3, the probability that the analysis of a QC check standard will be required is high. In this case the QC check standard should be routinely analyzed with the spike sample.

8.4.1 Prepare the QC check standard by adding 1.0 mL of QC check sample concentrate (Section 8.2.1 or 8.3.2) to 1 L of reagent water. The QC check standard needs only to contain the parameters that failed criteria in the test in Section 8.3.

8.4.2 Analyze the QC check standard to determine the concentration measured (A) of each parameter. Calculate each percent recovery (P_s) as $100(A/T)\%$, where T is the true value of the standard concentration.

8.4.3 Compare the percent recovery (P_s) for each parameter with the corresponding QC acceptance criteria found in Table 6. Only parameters that failed the test in Section 8.3 need to be compared with these criteria. If the recovery of any such parameter falls outside the designated range, the laboratory performance for that parameter is judged to be out of control, and the problem must be immediately identified and corrected. The analytical result for that parameter in the unspiked sample is suspect and may not be reported for regulatory compliance purposes.

8.5 As part of the QC program for the laboratory, method accuracy for wastewater samples must be assessed and records must be maintained. After the analysis of five spiked wastewater samples as in Section 8.3, calculate the average percent recovery (\bar{P}) and the standard deviation of the percent recovery (s_p). Express the accuracy assessment as a percent interval from $\bar{P} - 2s_p$ to $\bar{P} + 2s_p$. If $\bar{P} = 90\%$ and $s_p = 10\%$, for example, the accuracy interval is expressed as 70–110%. Update the accuracy assessment for each parameter on a regular basis (e.g. after each five to ten new accuracy measurements).

8.6 As a quality control check, the laboratory must spike all samples with the surrogate standard spiking solution as described in Section 10.2, and calculate the percent recovery of each surrogate compound.

8.7 It is recommended that the laboratory adopt additional quality assurance practices for use with this method. The specific practices that are most productive depend upon the needs of the laboratory and the nature of

the samples. Field duplicates may be analyzed to assess the precision of the environmental measurements. Whenever possible, the laboratory should analyze standard reference materials and participate in relevant performance evaluation studies.

9. Sample Collection, Preservation, and Handling

9.1 Grab samples must be collected in glass containers. Conventional sampling practices⁸ should be followed, except that the bottle must not be prerinsed with sample before collection. Composite samples should be collected in refrigerated glass containers in accordance with the requirements of the program. Automatic sampling equipment must be as free as possible of Tygon tubing and other potential sources of contamination.

9.2 All sampling must be iced or refrigerated at 4 °C from the time of collection until extraction. Fill the sample bottles and, if residual chlorine is present, add 80 mg of sodium thiosulfate per liter of sample and mix well. EPA Methods 330.4 and 330.5 may be used for measurement of residual chlorine.⁹ Field test kits are available for this purpose.

9.3 All samples must be extracted within 7 days of collection and completely analyzed within 40 days of extraction.

10. Separatory Funnel Extraction

10.1 Samples are usually extracted using separatory funnel techniques. If emulsions will prevent achieving acceptable solvent recovery with separatory funnel extractions, continuous extraction (Section 11) may be used. The separatory funnel extraction scheme described below assumes a sample volume of 1 L. When sample volumes of 2 L are to be extracted, use 250, 100, and 100-mL volumes of methylene chloride for the serial extraction of the base/neutrals and 200, 100, and 100-mL volumes of methylene chloride for the acids.

10.2 Mark the water meniscus on the side of the sample bottle for later determination of sample volume. Pour the entire sample into a 2-L separatory funnel. Pipet 1.00 mL of the surrogate standard spiking solution into the separatory funnel and mix well. Check the pH of the sample with wide-range pH paper and adjust to pH>11 with sodium hydroxide solution.

10.3 Add 60 mL of methylene chloride to the sample bottle, seal, and shake for 30 s to rinse the inner surface. Transfer the solvent to the separatory funnel and extract the sample by shaking the funnel for 2 min. with periodic venting to release excess pressure. Allow the organic layer to separate from the water phase for a minimum of 10 min. If the emulsion interface between layers is more than one-third the volume of the solvent

layer, the analyst must employ mechanical techniques to complete the phase separation. The optimum technique depends upon the sample, but may include stirring, filtration of the emulsion through glass wool, centrifugation, or other physical methods. Collect the methylene chloride extract in a 250-mL Erlenmeyer flask. If the emulsion cannot be broken (recovery of less than 80% of the methylene chloride, corrected for the water solubility of methylene chloride), transfer the sample, solvent, and emulsion into the extraction chamber of a continuous extractor and proceed as described in Section 11.3.

10.4 Add a second 60-mL volume of methylene chloride to the sample bottle and repeat the extraction procedure a second time, combining the extracts in the Erlenmeyer flask. Perform a third extraction in the same manner. Label the combined extract as the base/neutral fraction.

10.5 Adjust the pH of the aqueous phase to less than 2 using sulfuric acid. Serially extract the acidified aqueous phase three times with 60-mL aliquots of methylene chloride. Collect and combine the extracts in a 250-mL Erlenmeyer flask and label the combined extracts as the acid fraction.

10.6 For each fraction, assemble a Kuderna-Danish (K-D) concentrator by attaching a 10-mL concentrator tube to a 500-mL evaporative flask. Other concentration devices or techniques may be used in place of the K-D concentrator if the requirements of Section 8.2 are met.

10.7 For each fraction, pour the combined extract through a solvent-rinsed drying column containing about 10 cm of anhydrous sodium sulfate, and collect the extract in the K-D concentrator. Rinse the Erlenmeyer flask and column with 20 to 30 mL of methylene chloride to complete the quantitative transfer.

10.8 Add one or two clean boiling chips and attach a three-ball Snyder column to the evaporative flask for each fraction. Prewet each Snyder column by adding about 1 mL of methylene chloride to the top. Place the K-D apparatus on a hot water bath (60 to 65 °C) so that the concentrator tube is partially immersed in the hot water, and the entire lower rounded surface of the flask is bathed with hot vapor. Adjust the vertical position of the apparatus and the water temperature as required to complete the concentration in 15 to 20 min. At the proper rate of distillation the balls of the column will actively chatter but the chambers will not flood with condensed solvent. When the apparent volume of liquid reaches 1 mL, remove the K-D apparatus from the water bath and allow it to drain and cool for at least 10 min. Remove the Snyder column and rinse the flask and its lower joint into the concentrator tube with 1 to 2 mL of methylene chloride. A 5-mL syringe is recommended for this operation.

10.9 Add another one or two clean boiling chips to the concentrator tube for each fraction and attach a two-ball micro-Snyder column. Prewet the Snyder column by adding about 0.5 mL of methylene chloride to the top. Place the K-D apparatus on a hot water bath (60 to 65 °C) so that the concentrator tube is partially immersed in hot water. Adjust the vertical position of the apparatus and the water temperature as required to complete the concentration in 5 to 10 min. At the proper rate of distillation the balls of the column will actively chatter but the chambers will not flood with condensed solvent. When the apparent volume of liquid reaches about 0.5 mL, remove the K-D apparatus from the water bath and allow it to drain and cool for at least 10 min. Remove the Snyder column and rinse the flask and its lower joint into the concentrator tube with approximately 0.2 mL of acetone or methylene chloride. Adjust the final volume to 1.0 mL with the solvent. Stopper the concentrator tube and store refrigerated if further processing will not be performed immediately. If the extracts will be stored longer than two days, they should be transferred to Teflon-sealed screw-cap vials and labeled base/neutral or acid fraction as appropriate.

10.10 Determine the original sample volume by refilling the sample bottle to the mark and transferring the liquid to a 1000-mL graduated cylinder. Record the sample volume to the nearest 5 mL.

11. Continuous Extraction

11.1 When experience with a sample from a given source indicates that a serious emulsion problem will result or an emulsion is encountered using a separatory funnel in Section 10.3, a continuous extractor should be used.

11.2 Mark the water meniscus on the side of the sample bottle for later determination of sample volume. Check the pH of the sample with wide-range pH paper and adjust to pH >11 with sodium hydroxide solution. Transfer the sample to the continuous extractor and using a pipet, add 1.00 mL of surrogate standard spiking solution and mix well. Add 60 mL of methylene chloride to the sample bottle, seal, and shake for 30 s to rinse the inner surface. Transfer the solvent to the extractor.

11.3 Repeat the sample bottle rinse with an additional 50 to 100-mL portion of methylene chloride and add the rinse to the extractor.

11.4 Add 200 to 500 mL of methylene chloride to the distilling flask, add sufficient reagent water to ensure proper operation, and extract for 24 h. Allow to cool, then detach the distilling flask. Dry, concentrate, and seal the extract as in Sections 10.6 through 10.9.

11.5 Charge a clean distilling flask with 500 mL of methylene chloride and attach it

to the continuous extractor. Carefully, while stirring, adjust the pH of the aqueous phase to less than 2 using sulfuric acid. Extract for 24 h. Dry, concentrate, and seal the extract as in Sections 10.6 through 10.9.

12. Daily GC/MS Performance Tests

12.1 At the beginning of each day that analyses are to be performed, the GC/MS system must be checked to see if acceptable performance criteria are achieved for DFTPP.¹⁰ Each day that benzidine is to be determined, the tailing factor criterion described in Section 12.4 must be achieved. Each day that the acids are to be determined, the tailing factor criterion in Section 12.5 must be achieved.

12.2 These performance tests require the following instrumental parameters:

Electron Energy: 70 V (nominal)

Mass Range: 35 to 450 amu

Scan Time: To give at least 5 scans per peak but not to exceed 7 s per scan.

12.3 DFTPP performance test—At the beginning of each day, inject 2 µL (50 ng) of DFTPP standard solution. Obtain a background-corrected mass spectra of DFTPP and confirm that all the key m/z criteria in Table 9 are achieved. If all the criteria are not achieved, the analyst must retune the mass spectrometer and repeat the test until all criteria are achieved. The performance criteria must be achieved before any samples, blanks, or standards are analyzed. The tailing factor tests in Sections 12.4 and 12.5 may be performed simultaneously with the DFTPP test.

12.4 Column performance test for base/ neutrals—At the beginning of each day that the base/neutral fraction is to be analyzed for benzidine, the benzidine tailing factor must be calculated. Inject 100 ng of benzidine either separately or as a part of a standard mixture that may contain DFTPP and calculate the tailing factor. The benzidine tailing factor must be less than 3.0. Calculation of the tailing factor is illustrated in Figure 13.¹¹ Replace the column packing if the tailing factor criterion cannot be achieved.

12.5 Column performance test for acids—At the beginning of each day that the acids are to be determined, inject 50 ng of pentachlorophenol either separately or as a part of a standard mix that may contain DFTPP. The tailing factor for pentachlorophenol must be less than 5. Calculation of the tailing factor is illustrated in Figure 13.¹¹ Replace the column packing if the tailing factor criterion cannot be achieved.

13. Gas Chromatography/Mass Spectrometry

13.1 Table 4 summarizes the recommended gas chromatographic operating conditions for the base/neutral fraction. Table 5 summarizes the recommended gas chromatographic

operating conditions for the acid fraction. Included in these tables are retention times and MDL that can be achieved under these conditions. Examples of the separations achieved by these columns are shown in Figures 1 through 12. Other packed or capillary (open-tubular) columns or chromatographic conditions may be used if the requirements of Section 8.2 are met.

13.2 After conducting the GC/MS performance tests in Section 12, calibrate the system daily as described in Section 7.

13.3 The internal standard must be added to sample extract and mixed thoroughly immediately before it is injected into the instrument. This procedure minimizes losses due to adsorption, chemical reaction or evaporation.

13.4 Inject 2 to 5 μL of the sample extract or standard into the GC/MS system using the solvent-flush technique.¹² Smaller (1.0 μL) volumes may be injected if automatic devices are employed. Record the volume injected to the nearest 0.05 μL .

13.5 If the response for any m/z exceeds the working range of the GC/MS system, dilute the extract and reanalyze.

13.6 Perform all qualitative and quantitative measurements as described in Sections 14 and 15. When the extracts are not being used for analyses, store them refrigerated at 4°C, protected from light in screw-cap vials equipped with unpierced Teflon-lined septa.

14. Qualitative Identification

14.1 Obtain EICPs for the primary m/z and the two other masses listed in Tables 4 and 5. See Section 7.3 for masses to be used with internal and surrogate standards. The following criteria must be met to make a qualitative identification:

14.1.1 The characteristic masses of each parameter of interest must maximize in the same or within one scan of each other.

14.1.2 The retention time must fall within ± 30 s of the retention time of the authentic compound.

14.1.3 The relative peak heights of the three characteristic masses in the EICPs must fall within $\pm 20\%$ of the relative intensities of these masses in a reference mass spectrum. The reference mass spectrum can be obtained from a standard analyzed in the GC/MS system or from a reference library.

14.2 Structural isomers that have very similar mass spectra and less than 30 s difference in retention time, can be explicitly identified only if the resolution between authentic isomers in a standard mix is acceptable. Acceptable resolution is achieved if the baseline to valley height between the isomers is less than 25% of the sum of the two peak heights. Otherwise, structural isomers are identified as isomeric pairs.

15. Calculations

15.1 When a parameter has been identified, the quantitation of that parameter will be based on the integrated abundance from the EICP of the primary characteristic m/z in Tables 4 and 5. Use the base peak m/z for internal and surrogate standards. If the sample produces an interference for the primary m/z, use a secondary characteristic m/z to quantitate.

Calculate the concentration in the sample using the response factor (RF) determined in Section 7.2.2 and Equation 3.

$$\text{Concentration } (\mu\text{g/L}) = \frac{(A_s)(I_s)}{(A_{is})(\text{RF})(V_o)}$$

Equation 3

where:

A_s = Area of the characteristic m/z for the parameter or surrogate standard to be measured.

A_{is} = Area of the characteristic m/z for the internal standard.

I_s = Amount of internal standard added to each extract (μg).

V_o = Volume of water extracted (L).

15.2 Report results in $\mu\text{g/L}$ without correction for recovery data. All QC data obtained should be reported with the sample results.

16. Method Performance

16.1 The method detection limit (MDL) is defined as the minimum concentration of a substance that can be measured and reported with 99% confidence that the value is above zero.¹ The MDL concentrations listed in Tables 4 and 5 were obtained using reagent water.¹³ The MDL actually achieved in a given analysis will vary depending on instrument sensitivity and matrix effects.

16.2 This method was tested by 15 laboratories using reagent water, drinking water, surface water, and industrial wastewaters spiked at six concentrations over the range 5 to 1300 $\mu\text{g/L}$.¹⁴ Single operator precision, overall precision, and method accuracy were found to be directly related to the concentration of the parameter and essentially independent of the sample matrix. Linear equations to describe these relationships are presented in Table 7.

17. Screening Procedure for 2,3,7,8-Tetrachlorodibenzo-p-dioxin (2,3,7,8-TCDD)

17.1 If the sample must be screened for the presence of 2,3,7,8-TCDD, it is recommended that the reference material not be handled in the laboratory unless extensive safety precautions are employed. It is sufficient to analyze the base/neutral extract by selected ion monitoring (SIM) GC/MS techniques, as follows:

17.1.1 Concentrate the base/neutral extract to a final volume of 0.2 ml.

17.1.2 Adjust the temperature of the base/neutral column (Section 5.6.2) to 220 °C.

17.1.3 Operate the mass spectrometer to acquire data in the SIM mode using the ions at m/z 257, 320 and 322 and a dwell time no greater than 333 milliseconds per mass.

17.1.4 Inject 5 to 7 µL of the base/neutral extract. Collect SIM data for a total of 10 min.

17.1.5 The possible presence of 2,3,7,8-TCDD is indicated if all three masses exhibit simultaneous peaks at any point in the selected ion current profiles.

17.1.6 For each occurrence where the possible presence of 2,3,7,8-TCDD is indicated, calculate and retain the relative abundances of each of the three masses.

17.2 False positives to this test may be caused by the presence of single or coeluting combinations of compounds whose mass spectra contain all of these masses.

17.3 Conclusive results of the presence and concentration level of 2,3,7,8-TCDD can be obtained only from a properly equipped laboratory through the use of EPA Method 613 or other approved alternate test procedures.

REFERENCES

- 40 CFR part 136, appendix B.
- "Sampling and Analysis Procedures for Screening of Industrial Effluents for Priority Pollutants," U.S. Environmental Protection Agency, Environmental Monitoring and Support Laboratory, Cincinnati, Ohio 45268, March 1977, Revised April 1977. Available from Effluent Guidelines Division, Washington, DC 20460.
- ASTM Annual Book of Standards, Part 31, D3694-78. "Standard Practices for Preparation of Sample Containers and for Preservation of Organic Constituents," American Society for Testing and Materials, Philadelphia.
- "Carcinogens—Working With Carcinogens," Department of Health, Education, and Welfare, Public Health Service, Center for Disease Control, National Institute for Occupational Safety and Health, Publication No. 77-206, August 1977.
- "OSHA Safety and Health Standards, General Industry," (29 CFR part 1910), Occupational Safety and Health Administration, OSHA 2206 (Revised, January 1976).
- "Safety in Academic Chemistry Laboratories," American Chemical Society Publication, Committee on Chemical Safety, 3rd Edition, 1979.
- Provost, L.P., and Elder, R.S. "Interpretation of Percent Recovery Data," *American Laboratory*, 15, 58-63 (1983). (The value 2.44 used in the equation in Section 8.3.3 is two times the value 1.22 derived in this report.)
- ASTM Annual Book of Standards, Part 31, D3370-76. "Standard Practices for Sampling Water," American Society for Testing and Materials, Philadelphia.

- "Methods 330.4 (Titrimetric, DPD-FAS) and 330.5 (Spectrophotometric, DPD) for Chlorine, Total Residual," Methods for Chemical Analysis of Water and Wastes, EPA-600/4-79-020, U.S. Environmental Protection Agency, Environmental Monitoring and Support Laboratory, Cincinnati, Ohio 45268, March 1979.

- Eichelberger, J.W., Harris, L.E., and Budde, W.L. "Reference Compound to Calibrate Ion Abundance Measurement in Gas Chromatography-Mass Spectrometry," *Analytical Chemistry*, 47, 995 (1975).

- McNair, N.M. and Bonelli, E.J. "Basic Chromatography," Consolidated Printing, Berkeley, California, p. 52, 1969.

- Burke, J.A. "Gas Chromatography for Pesticide Residue Analysis; Some Practical Aspects," *Journal of the Association of Official Analytical Chemists*, 48, 1037 (1965).

- Olynyk, P., Budde, W.L., and Eichelberger, J.W. "Method Detection Limit for Methods 624 and 625," Unpublished report, May 14, 1980.

- "EPA Method Study 30, Method 625, Base/Neutrals, Acids, and Pesticides," EPA 600/4-84-053, National Technical Information Service, PB84-206572, Springfield, Virginia 22161, June 1984.

TABLE 1—BASE/NEUTRAL EXTRACTABLES

| Parameter | STORET No. | CAS No. |
|---|------------|-----------|
| Acenaphthene | 34205 | 83-32-9 |
| Acenaphthylene | 34200 | 208-96-8 |
| Anthracene | 34220 | 120-12-7 |
| Aldrin | 39330 | 309-00-2 |
| Benzo(a)anthracene | 34526 | 56-55-3 |
| Benzo(b)fluoranthene | 34230 | 205-99-2 |
| Benzo(k)fluoranthene | 34242 | 207-08-9 |
| Benzo(a)pyrene | 34247 | 50-32-8 |
| Benzo(ghi)perylene | 34521 | 191-24-2 |
| Benzyl butyl phthalate | 34292 | 85-68-7 |
| β-BHC | 39338 | 319-85-7 |
| δ-BHC | 34259 | 319-86-8 |
| Bis(2-chloroethyl) ether | 34273 | 111-44-4 |
| Bis(2-chloroethoxy)methane | 34278 | 111-91-1 |
| Bis(2-ethylhexyl) phthalate | 39100 | 117-81-7 |
| Bis(2-chloroisopropyl) ether ^a | 34283 | 108-60-1 |
| 4-Bromophenyl phenyl ether ^a | 34636 | 101-55-3 |
| Chlordane | 39350 | 57-74-9 |
| 2-Chloronaphthalele | 34581 | 91-58-7 |
| 4-Chlorophenyl phenyl ether | 34641 | 7005-72-3 |
| Chrysene | 34320 | 218-01-9 |
| 4,4'-DDD | 39310 | 72-54-8 |
| 4,4'-DDE | 39320 | 72-55-9 |
| 4,4'-DDT | 39300 | 50-29-3 |
| Dibenzo(a,h)anthracene | 34556 | 53-70-3 |
| Di-n-butylphthalate | 39110 | 84-74-2 |
| 1,3-Dichlorobenzene | 34566 | 541-73-1 |
| 1,2-Dichlorobenzene | 34536 | 95-50-1 |
| 1,4-Dichlorobenzene | 34571 | 106-46-7 |
| 3,3'-Dichlorobenzidine | 34631 | 91-94-1 |
| Dieldrin | 39380 | 60-57-1 |
| Diethyl phthalate | 34336 | 84-66-2 |
| Dimethyl phthalate | 34341 | 131-11-3 |
| 2,4-Dinitrotoluene | 34611 | 121-14-2 |
| 2,6-Dinitrotoluene | 34626 | 606-20-2 |
| Di-n-octylphthalate | 34596 | 117-84-0 |
| Endosulfan sulfate | 34351 | 1031-07-8 |

Environmental Protection Agency

Pt. 136, App. A, Meth. 625

TABLE 1—BASE/NEUTRAL EXTRACTABLES—Continued

| Parameter | STORET No. | CAS No. |
|---------------------------------|------------|------------|
| Endrin aldehyde | 34366 | 7421-93-4 |
| Fluoranthene | 34376 | 206-44-0 |
| Fluorene | 34381 | 86-73-7 |
| Heptachlor | 39410 | 76-44-8 |
| Heptachlor epoxide | 39420 | 1024-57-3 |
| Hexachlorobenzene | 39700 | 118-74-1 |
| Hexachlorobutadiene | 34391 | 87-68-3 |
| Hexachloroethane | 34396 | 67-72-1 |
| Indeno(1,2,3-cd)pyrene | 34403 | 193-39-5 |
| Isophorone | 34408 | 78-59-1 |
| Naphthalene | 34696 | 91-20-3 |
| Nitrobenzene | 34447 | 98-95-3 |
| N-Nitrosodi-n-propylamine | 34428 | 621-64-7 |
| PCB-1016 | 34671 | 12674-11-2 |
| PCB-1221 | 39488 | 11104-28-2 |
| PCB-1232 | 39492 | 11141-16-5 |
| PCB-1242 | 39496 | 53469-21-9 |
| PCB-1248 | 39500 | 12672-29-6 |
| PCB-1254 | 39504 | 11097-69-1 |
| PCB-1260 | 39508 | 11096-82-5 |
| Phenanthrene | 34461 | 85-01-8 |
| Pyrene | 34469 | 129-00-0 |
| Toxaphene | 39400 | 8001-35-2 |
| 1,2,4-Trichlorobenzene | 34551 | 120-82-1 |

^aThe proper chemical name is 2,2'-oxybis(1-chloropropane).

TABLE 2—ACID EXTRACTABLES

| Parameter | STORET No. | CAS No. |
|----------------------------------|------------|----------|
| 4-Chloro-3-methylphenol | 34452 | 59-50-7 |
| 2-Chlorophenol | 34586 | 95-57-8 |
| 2,4-Dichlorophenol | 34601 | 120-83-2 |
| 2,4-Dimethylphenol | 34606 | 105-67-9 |
| 2,4-Dinitrophenol | 34616 | 51-28-5 |
| 2-Methyl-4,6-dinitrophenol | 34657 | 534-52-1 |
| 2-Nitrophenol | 34591 | 88-75-5 |
| 4-Nitrophenol | 34646 | 100-02-7 |
| Pentachlorophenol | 39032 | 87-86-5 |
| Phenol | 34694 | 108-95-2 |
| 2,4,6-Trichlorophenol | 34621 | 88-06-2 |

TABLE 3—ADDITIONAL EXTRACTABLE PARAMETERS ^A

| Parameter | STORET No. | CAS No. | Method |
|---------------------------------|------------|------------|--------|
| Benzidine | 39120 | 92-87-5 | 605 |
| β-BHC | 39337 | 319-84-6 | 608 |
| δ-BHC | 39340 | 58-89-8 | 608 |
| Endosulfan I | 34361 | 959-98-8 | 608 |
| Endosulfan II | 34356 | 33213-65-9 | 608 |
| Endrin | 39390 | 72-20-8 | 608 |
| Hexachlorocyclopentadiene | 34386 | 77-47-4 | 612 |
| N-Nitrosodimethylamine | 34438 | 62-75-9 | 607 |
| N-Nitrosodiphenylamine | 34433 | 86-30-6 | 607 |

^aSee Section 1.2.

TABLE 4—CHROMATOGRAPHIC CONDITIONS, METHOD DETECTION LIMITS, AND CHARACTERISTIC MASSES FOR BASE/NEUTRAL EXTRACTABLES

| Parameter | Retention time (min) | Method detection limit (µg/L) | Characteristic masses | | | | | |
|---|----------------------|-------------------------------|-----------------------|-----------|-----------|---------------------|---------|---------|
| | | | Electron impact | | | Chemical ionization | | |
| | | | Primary | Secondary | Secondary | Methane | Methane | Methane |
| 1,3-Dichlorobenzene | 7.4 | 1.9 | 146 | 148 | 113 | 146 | 148 | 150 |
| 1,4-Dichlorobenzene | 7.8 | 4.4 | 146 | 148 | 113 | 146 | 148 | 150 |
| Hexachloroethane | 8.4 | 1.6 | 117 | 201 | 199 | 199 | 201 | 203 |
| Bis(2-chloroethyl) ether ^a | 8.4 | 5.7 | 93 | 63 | 95 | 63 | 107 | 109 |
| 1,2-Dichlorobenzene | 8.4 | 1.9 | 146 | 148 | 113 | 146 | 148 | 150 |
| Bis(2-chloroisopropyl) ether ^a | 9.3 | 5.7 | 45 | 77 | 79 | 77 | 135 | 137 |
| N-Nitrosodi-n-propylamine | | | 130 | 42 | 101 | | | |
| Nitrobenzene | 11.1 | 1.9 | 77 | 123 | 65 | 124 | 152 | 164 |
| Hexachlorobutadiene | 11.4 | 0.9 | 225 | 223 | 227 | 223 | 225 | 227 |
| 1,2,4-Trichlorobenzene | 11.6 | 1.9 | 180 | 182 | 145 | 181 | 183 | 209 |
| Isophorone | 11.9 | 2.2 | 82 | 95 | 138 | 139 | 167 | 178 |
| Naphthalene | 12.1 | 1.6 | 128 | 129 | 127 | 129 | 157 | 169 |
| Bis(2-chloroethoxy) methane | 12.2 | 5.3 | 93 | 95 | 123 | 65 | 107 | 137 |
| Hexachlorocyclopentadiene ^a | 13.9 | | 237 | 235 | 272 | 235 | 237 | 239 |
| 2-Chloronaphthalene | 15.9 | 1.9 | 162 | 164 | 127 | 163 | 191 | 203 |
| Acenaphthylene | 17.4 | 3.5 | 152 | 151 | 153 | 152 | 153 | 181 |
| Acenaphthene | 17.8 | 1.9 | 154 | 153 | 152 | 154 | 155 | 183 |
| Dimethyl phthalate | 18.3 | 1.6 | 163 | 194 | 164 | 151 | 163 | 164 |
| 2,6-Dinitrotoluene | 18.7 | 1.9 | 165 | 89 | 121 | 183 | 211 | 223 |
| Fluorene | 19.5 | 1.9 | 166 | 165 | 167 | 166 | 167 | 195 |
| 4-Chlorophenyl phenyl ether | 19.5 | 4.2 | 204 | 206 | 141 | | | |
| 2,4-Dinitrotoluene | 19.8 | 5.7 | 165 | 63 | 182 | 183 | 211 | 223 |
| Diethyl phthalate | 20.1 | 1.9 | 149 | 177 | 150 | 177 | 223 | 251 |
| N-Nitrosodiphenylamine ^b | 20.5 | 1.9 | 169 | 168 | 167 | 169 | 170 | 198 |
| Hexachlorobenzene | 21.0 | 1.9 | 284 | 142 | 249 | 284 | 286 | 288 |
| β-BHC ^b | 21.1 | | 183 | 181 | 109 | | | |
| 4-Bromophenyl phenyl ether | 21.2 | 1.9 | 248 | 250 | 141 | 249 | 251 | 277 |
| δ-BHC ^b | 22.4 | | 183 | 181 | 109 | | | |
| Phenanthrene | 22.8 | 5.4 | 178 | 179 | 176 | 178 | 179 | 207 |
| Anthracene | 22.8 | 1.9 | 178 | 179 | 176 | 178 | 179 | 207 |
| β-BHC | 23.4 | 4.2 | 181 | 183 | 109 | | | |

TABLE 4—CHROMATOGRAPHIC CONDITIONS, METHOD DETECTION LIMITS, AND CHARACTERISTIC MASSES FOR BASE/NEUTRAL EXTRACTABLES—Continued

| Parameter | Retention time (min) | Method detection limit (µg/L) | Characteristic masses | | | | | |
|-------------------------------------|----------------------|-------------------------------|-----------------------|------------|------------|---------------------|---------|---------|
| | | | Electron impact | | | Chemical ionization | | |
| | | | Primary | Sec-ondary | Sec-ondary | Methane | Methane | Methane |
| Heptachlor | 23.4 | 1.9 | 100 | 272 | 274 | | | |
| δ-BHC | 23.7 | 3.1 | 183 | 109 | 181 | | | |
| Aldrin | 24.0 | 1.9 | 66 | 263 | 220 | | | |
| Dibutyl phthalate | 24.7 | 2.5 | 149 | 150 | 104 | 149 | 205 | 279 |
| Heptachlor epoxide | 25.6 | 2.2 | 353 | 355 | 351 | | | |
| Endosulfan I ^b | 26.4 | | 237 | 339 | 341 | | | |
| Fluoranthene | 26.5 | 2.2 | 202 | 101 | 100 | 203 | 231 | 243 |
| Dieldrin | 27.2 | 2.5 | 79 | 263 | 279 | | | |
| 4,4'-DDE | 27.2 | 5.6 | 246 | 248 | 176 | | | |
| Pyrene | 27.3 | 1.9 | 202 | 101 | 100 | 203 | 231 | 243 |
| Endrin ^b | 27.9 | | 81 | 263 | 82 | | | |
| Endosulfan II ^b | 28.6 | | 237 | 339 | 341 | | | |
| 4,4'-DDD | 28.6 | 2.8 | 235 | 237 | 165 | | | |
| Benzidine ^b | 28.8 | 44 | 184 | 92 | 185 | 185 | 213 | 225 |
| 4,4'-DDT | 29.3 | 4.7 | 235 | 237 | 165 | | | |
| Endosulfan sulfate | 29.8 | 5.6 | 272 | 387 | 422 | | | |
| Endrin aldehyde | | | 67 | 345 | 250 | | | |
| Butyl benzyl phthalate | 29.9 | 2.5 | 149 | 91 | 206 | 149 | 299 | 327 |
| Bis(2-ethylhexyl) phthalate | 30.6 | 2.5 | 149 | 167 | 279 | 149 | | |
| Chrysene | 31.5 | 2.5 | 228 | 226 | 229 | 228 | 229 | 257 |
| Benzo(a)anthracene | 31.5 | 7.8 | 228 | 229 | 226 | 228 | 229 | 257 |
| 3,3'-Dichlorobenzidine | 32.2 | 16.5 | 252 | 254 | 126 | | | |
| Di-n-octyl phthalate | 32.5 | 2.5 | 149 | | | | | |
| Benzo(b)fluoranthene | 34.9 | 4.8 | 252 | 253 | 125 | 252 | 253 | 281 |
| Benzo(k)fluoranthene | 34.9 | 2.5 | 252 | 253 | 125 | 252 | 253 | 281 |
| Benzo(a)pyrene | 36.4 | 2.5 | 252 | 253 | 125 | 252 | 253 | 281 |
| Indeno(1,2,3-cd) pyrene | 42.7 | 3.7 | 276 | 138 | 277 | 276 | 277 | 305 |
| Dibenzo(a,h)anthracene | 43.2 | 2.5 | 278 | 139 | 279 | 278 | 279 | 307 |
| Benzo(ghi)perylene | 45.1 | 4.1 | 276 | 138 | 277 | 276 | 277 | 305 |
| N-Nitrosodimethylamine ^b | | | 42 | 74 | 44 | | | |
| Chlordane ^c | 19-30 | | 373 | 375 | 377 | | | |
| Toxaphene ^c | 25-34 | | 159 | 231 | 233 | | | |
| PCB 1016 ^c | 18-30 | | 224 | 260 | 294 | | | |
| PCB 1221 ^c | 15-30 | 30 | 190 | 224 | 260 | | | |
| PCB 1232 ^c | 15-32 | | 190 | 224 | 260 | | | |
| PCB 1242 ^c | 15-32 | | 224 | 260 | 294 | | | |
| PCB 1248 ^c | 12-34 | | 294 | 330 | 262 | | | |
| PCB 1254 ^c | 22-34 | 36 | 294 | 330 | 362 | | | |
| PCB 1260 ^c | 23-32 | | 330 | 362 | 394 | | | |

^aThe proper chemical name is 2,2'-bisoxy(1-chloropropane).

^bSee Section 1.2.

^cThese compounds are mixtures of various isomers (See Figures 2 through 12). Column conditions: Supelcoport (100/120 mesh) coated with 3% SP-2250 packed in a 1.8 m long × 2 mm ID glass column with helium carrier gas at 30 mL/min. flow rate. Column temperature held isothermal at 50°C for 4 min., then programmed at 8°C/min. to 270°C and held for 30 min.

TABLE 5—CHROMATOGRAPHIC CONDITIONS, METHOD DETECTION LIMITS, AND CHARACTERISTIC MASSES FOR ACID EXTRACTABLES

| Parameter | Retention time (min) | Method detection limit (µg/L) | Characteristic masses | | | | | |
|----------------------------|----------------------|-------------------------------|-----------------------|------------|------------|---------------------|---------|---------|
| | | | Electron Impact | | | Chemical ionization | | |
| | | | Primary | Sec-ondary | Sec-ondary | Methane | Methane | Methane |
| 2-Chlorophenol | 5.9 | 3.3 | 128 | 64 | 130 | 129 | 131 | 157 |
| 2-Nitrophenol | 6.5 | 3.6 | 139 | 65 | 109 | 140 | 168 | 122 |
| Phenol | 8.0 | 1.5 | 94 | 65 | 66 | 95 | 123 | 135 |
| 2,4-Dimethylphenol | 9.4 | 2.7 | 122 | 107 | 121 | 123 | 151 | 163 |
| 2,4-Dichlorophenol | 9.8 | 2.7 | 162 | 164 | 98 | 163 | 165 | 167 |
| 2,4,6-Trichlorophenol | 11.8 | 2.7 | 196 | 198 | 200 | 197 | 199 | 201 |
| 4-Chloro-3-methylphenol | 13.2 | 3.0 | 142 | 107 | 144 | 143 | 171 | 183 |
| 2,4-Dinitrophenol | 15.9 | 42 | 184 | 63 | 154 | 185 | 213 | 225 |
| 2-Methyl-4,6-dinitrophenol | 16.2 | 24 | 198 | 182 | 77 | 199 | 227 | 239 |
| Pentachlorophenol | 17.5 | 3.6 | 266 | 264 | 268 | 267 | 265 | 269 |

TABLE 5—CHROMATOGRAPHIC CONDITIONS, METHOD DETECTION LIMITS, AND CHARACTERISTIC MASSES FOR ACID EXTRACTABLES—Continued

| Parameter | Reten- tion time (min) | Method detection limit (µg/L) | Characteristic masses | | | | | |
|---------------------|------------------------------|--|-----------------------|----------------|----------------|---------------------|---------|---------|
| | | | Electron Impact | | | Chemical ionization | | |
| | | | Primary | Sec- ondary | Sec- ondary | Methane | Methane | Methane |
| 4-Nitrophenol | 20.3 | 2.4 | 65 | 139 | 109 | 140 | 168 | 122 |

Column conditions: Supelcoport (100/120 mesh) coated with 1% SP-1240DA packed in a 1.8 m long × 2mm ID glass column with helium carrier gas at 30 mL/min. flow rate. Column temperature held isothermal at 70 °C for 2 min. then programmed at 8 °C/min. to 200 °C.

TABLE 6—QC ACCEPTANCE CRITERIA—METHOD 625

| Parameter | Test conclu- sion (µg/L) | Limits for s (µg/L) | Range for X(µg/L) | Range for P, P _s (Per- cent) |
|---|-----------------------------|------------------------|----------------------|---|
| Acenaphthene | 100 | 27.6 | 60.1–132.3 | 47–145 |
| Acenaphthylene | 100 | 40.2 | 53.5–126.0 | 33–145 |
| Aldrin | 100 | 39.0 | 7.2–152.2 | D–166 |
| Anthracene | 100 | 32.0 | 43.4–118.0 | 27–133 |
| Benzo(a)anthracene | 100 | 27.6 | 41.8–133.0 | 33–143 |
| Benzo(b)fluoranthene | 100 | 38.8 | 42.0–140.4 | 24–159 |
| Benzo(k)fluoranthene | 100 | 32.3 | 25.2–145.7 | 11–162 |
| Benzo(a)pyrene | 100 | 39.0 | 31.7–148.0 | 17–163 |
| Benzo(ghi)perylene | 100 | 58.9 | D–195.0 | D–219 |
| Benzyl butyl phthalate | 100 | 23.4 | D–139.9 | D–152 |
| β-BHC | 100 | 31.5 | 41.5–130.6 | 24–149 |
| δ-BHC | 100 | 21.6 | D–100.0 | D–110 |
| Bis(2-chloroethyl) ether | 100 | 55.0 | 42.9–126.0 | 12–158 |
| Bis(2-chloroethoxy)methane | 100 | 34.5 | 49.2–164.7 | 33–184 |
| Bis(2-chloroisopropyl) ether ^a | 100 | 46.3 | 62.8–138.6 | 36–166 |
| Bis(2-ethylhexyl) phthalate | 100 | 41.1 | 28.9–136.8 | 8–158 |
| 4-Bromophenyl phenyl ether | 100 | 23.0 | 64.9–114.4 | 53–127 |
| 2-Chloronaphthalene | 100 | 13.0 | 64.5–113.5 | 60–118 |
| 4-Chlorophenyl phenyl ether | 100 | 33.4 | 38.4–144.7 | 25–158 |
| Chrysene | 100 | 48.3 | 44.1–139.9 | 17–168 |
| 4,4'-DDD | 100 | 31.0 | D–134.5 | D–145 |
| 4,4'-DDE | 100 | 32.0 | 19.2–119.7 | 4–136 |
| 4,4'-DDT | 100 | 61.6 | D–170.6 | D–203 |
| Dibenzo(a,h)anthracene | 100 | 70.0 | D–199.7 | D–227 |
| Di-n-butyl phthalate | 100 | 16.7 | 8.4–111.0 | 1–118 |
| 1,2-Dichlorobenzene | 100 | 30.9 | 48.6–112.0 | 32–129 |
| 1,3-Dichlorobenzene | 100 | 41.7 | 16.7–153.9 | D–172 |
| 1,4-Dichlorobenzene | 100 | 32.1 | 37.3–105.7 | 20–124 |
| 3,3'-Dichlorobenzidine | 100 | 71.4 | 8.2–212.5 | D–262 |
| Dieldrin | 100 | 30.7 | 44.3–119.3 | 29–136 |
| Diethyl phthalate | 100 | 26.5 | D–100.0 | D–114 |
| Dimethyl phthalate | 100 | 23.2 | D–100.0 | D–112 |
| 2,4-Dinitrotoluene | 100 | 21.8 | 47.5–126.9 | 39–139 |
| 2,6-Dinitrotoluene | 100 | 29.6 | 68.1–136.7 | 50–158 |
| Di-n-octyl phthalate | 100 | 31.4 | 18.6–131.8 | 4–146 |
| Endosulfan sulfate | 100 | 16.7 | D–103.5 | D–107 |
| Endrin aldehyde | 100 | 32.5 | D–188.8 | D–209 |
| Fluoranthene | 100 | 32.8 | 42.9–121.3 | 26–137 |
| Fluorene | 100 | 20.7 | 71.6–108.4 | 59–121 |
| Heptachlor | 100 | 37.2 | D–172.2 | D–192 |
| Heptachlor epoxide | 100 | 54.7 | 70.9–109.4 | 26–155 |
| Hexachlorobenzene | 100 | 24.9 | 7.8–141.5 | D–152 |
| Hexachlorobutadiene | 100 | 26.3 | 37.8–102.2 | 24–116 |
| Hexachloroethane | 100 | 24.5 | 55.2–100.0 | 40–113 |
| Indeno(1,2,3-cd)pyrene | 100 | 44.6 | D–150.9 | D–171 |
| Isophorone | 100 | 63.3 | 46.6–180.2 | 21–196 |
| Naphthalene | 100 | 30.1 | 35.6–119.6 | 21–133 |
| Nitrobenzene | 100 | 39.3 | 54.3–157.6 | 35–180 |
| N-Nitrosodi-n-propylamine | 100 | 55.4 | 13.6–197.9 | D–230 |
| PCB-1260 | 100 | 54.2 | 19.3–121.0 | D–164 |
| Phenanthrene | 100 | 20.6 | 65.2–108.7 | 54–120 |
| Pyrene | 100 | 25.2 | 69.6–100.0 | 52–115 |
| 1,2,4-Trichlorobenzene | 100 | 28.1 | 57.3–129.2 | 44–142 |
| 4-Chloro-3-methylphenol | 100 | 37.2 | 40.8–127.9 | 22–147 |
| 2-Chlorophenol | 100 | 28.7 | 36.2–120.4 | 23–134 |

TABLE 6—QC ACCEPTANCE CRITERIA—METHOD 625—Continued

| Parameter | Test conclusion (µg/L) | Limits for s (µg/L) | Range for X (µg/L) | Range for P, P _s (Percent) |
|----------------------------------|------------------------|---------------------|--------------------|---------------------------------------|
| 2,4-Dichlorophenol | 100 | 26.4 | 52.5–121.7 | 39–135 |
| 2,4-Dimethylphenol | 100 | 26.1 | 41.8–109.0 | 32–119 |
| 2,4-Dinitrophenol | 100 | 49.8 | D–172.9 | D–191 |
| 2-Methyl-4,6-dinitrophenol | 100 | 93.2 | 53.0–100.0 | D–181 |
| 2-Nitrophenol | 100 | 35.2 | 45.0–166.7 | 29–182 |
| 4-Nitrophenol | 100 | 47.2 | 13.0–106.5 | D–132 |
| Pentachlorophenol | 100 | 48.9 | 38.1–151.8 | 14–176 |
| Phenol | 100 | 22.6 | 16.6–100.0 | 5–112 |
| 2,4,6-Trichlorophenol | 100 | 31.7 | 52.4–129.2 | 37–144 |

s=Standard deviation for four recovery measurements, in µg/L (Section 8.2.4).

X=Average recovery for four recovery measurements, in µg/L (Section 8.2.4).

P, P_s=Percent recovery measured (Section 8.3.2, Section 8.4.2).

D=Detected; result must be greater than zero.

NOTE: These criteria are based directly upon the method performance data in Table 7. Where necessary, the limits for recovery have been broadened to assure applicability of the limits to concentrations below those used to develop Table 7.

^aThe proper chemical name is 2,2'-oxybis(1-chloropropane).

TABLE 7—METHOD ACCURACY AND PRECISION AS FUNCTIONS OF CONCENTRATION—METHOD 625

| Parameter | Accuracy, as recovery, X' (µg/L) | Single analyst precision, s, ^a (µg/L) | Overall precision, S' (µg/L) |
|---|----------------------------------|--|------------------------------|
| Acenaphthene | 0.96C=0.19 | 0.15X̄–0.12 | 0.21X̄–0.67 |
| Acenaphthylene | 0.89C=0.74 | 0.24X̄–1.06 | 0.26X̄–0.54 |
| Aldrin | 0.78C=1.66 | 0.27X̄–1.28 | 0.43X̄=1.13 |
| Anthracene | 0.80C=0.68 | 0.21X̄–0.32 | 0.27X̄–0.64 |
| Benzo(a)anthracene | 0.88C–0.60 | 0.15X̄=0.93 | 0.26X̄–0.28 |
| Benzo(b)fluoranthene | 0.93C–1.80 | 0.22X̄=0.43 | 0.29X̄=0.96 |
| Benzo(k)fluoranthene | 0.87C–1.56 | 0.19X̄=1.03 | 0.35X̄=0.40 |
| Benzo(a)pyrene | 0.90C–0.13 | 0.22X̄=0.48 | 0.32X̄=1.35 |
| Benzo(ghi)perylene | 0.98C–0.86 | 0.29X̄=2.40 | 0.51X̄–0.44 |
| Benzyl butyl phthalate | 0.66C–1.68 | 0.18X̄=0.94 | 0.53X̄=0.92 |
| β-BHC | 0.87C–0.94 | 0.20X̄–0.58 | 0.30X̄–1.94 |
| δ-BHC | 0.29C–1.09 | 0.34X̄=0.86 | 0.93X̄–0.17 |
| Bis(2-chloroethyl) ether | 0.86C–1.54 | 0.35X̄–0.99 | 0.35X̄=0.10 |
| Bis(2-chloroethoxy)methane | 1.12C–5.04 | 0.16X̄=1.34 | 0.26X̄=2.01 |
| Bis(2-chloroisopropyl) ether ^a | 1.03C–2.31 | 0.24X̄=0.28 | 0.25X̄=1.04 |
| Bis(2-ethylhexyl) phthalate | 0.84C–1.18 | 0.26X̄=0.73 | 0.36X̄=0.67 |
| 4-Bromophenyl phenyl ether | 0.91C–1.34 | 0.13X̄=0.66 | 0.16X̄=0.66 |
| 2-Chloronaphthalene | 0.89C=0.01 | 0.07X̄=0.52 | 0.13X̄=0.34 |
| 4-Chlorophenyl phenyl ether | 0.91C=0.53 | 0.20X̄–0.94 | 0.30X̄–0.46 |
| Chrysene | 0.93C–1.00 | 0.28X̄=0.13 | 0.33X̄–0.09 |
| 4,4'-DDD | 0.56C–0.40 | 0.29X̄–0.32 | 0.66X̄–0.96 |
| 4,4'-DDE | 0.70C–0.54 | 0.26X̄–1.17 | 0.39X̄–1.04 |
| 4,4'-DDT | 0.79C–3.28 | 0.42X̄=0.19 | 0.65X̄–0.58 |
| Dibenzo(a,h)anthracene | 0.88C=4.72 | 0.30X̄=8.51 | 0.59X̄=0.25 |
| Di-n-butyl phthalate | 0.59C=0.71 | 0.13X̄=1.16 | 0.39X̄=0.60 |
| 1,2-Dichlorobenzene | 0.80C=0.28 | 0.20X̄=0.47 | 0.24X̄=0.39 |
| 1,3-Dichlorobenzene | 0.86C–0.70 | 0.25X̄=0.68 | 0.41X̄=0.11 |
| 1,4-Dichlorobenzene | 0.73C–1.47 | 0.24X̄=0.23 | 0.29X̄=0.36 |
| 3,3'-Dichlorobenzidine | 1.23C–12.65 | 0.28X̄=7.33 | 0.47X̄=3.45 |
| Dieldrin | 0.82C–0.16 | 0.20X̄–0.16 | 0.26X̄–0.07 |
| Diethyl phthalate | 0.43C=1.00 | 0.28X̄=1.44 | 0.52X̄=0.22 |
| Dimethyl phthalate | 0.20C=1.03 | 0.54X̄=0.19 | 1.05X̄–0.92 |
| 2,4-Dinitrotoluene | 0.92C–4.81 | 0.12X̄=1.06 | 0.21X̄=1.50 |
| 2,6-Dinitrotoluene | 1.06C–3.60 | 0.14X̄=1.26 | 0.19X̄=0.35 |
| Di-n-octyl phthalate | 0.76C–0.79 | 0.21X̄=1.19 | 0.37X̄=1.19 |
| Endosulfan sulfate | 0.39C=0.41 | 0.12X̄=2.47 | 0.63X̄–1.03 |
| Endrin aldehyde | 0.76C–3.86 | 0.18X̄=3.91 | 0.73X̄–0.62 |
| Fluoranthene | 0.81C=1.10 | 0.22X̄–0.73 | 0.28X̄–0.60 |
| Fluorene | 0.90C–0.00 | 0.12X̄=0.26 | 0.13X̄=0.61 |
| Heptachlor | 0.87C–2.97 | 0.24X̄–0.56 | 0.50X̄–0.23 |
| Heptachlor epoxide | 0.92C–1.87 | 0.33X̄–0.46 | 0.28X̄=0.64 |
| Hexachlorobenzene | 0.74C=0.66 | 0.18X̄–0.10 | 0.43X̄–0.52 |
| Hexachlorobutadiene | 0.71C–1.01 | 0.19X̄=0.92 | 0.26X̄=0.49 |
| Hexachloroethane | 0.73C–0.83 | 0.17X̄=0.67 | 0.17X̄=0.80 |
| Indeno(1,2,3-cd)pyrene | 0.78C–3.10 | 0.29X̄=1.46 | 0.50X̄=0.44 |
| Isophorone | 1.12C=1.41 | 0.27X̄=0.77 | 0.33X̄=0.26 |
| Naphthalene | 0.76C=1.58 | 0.21X̄–0.41 | 0.30X̄–0.68 |

TABLE 7—METHOD ACCURACY AND PRECISION AS FUNCTIONS OF CONCENTRATION—METHOD 625—Continued

| Parameter | Accuracy, as recovery, X' (µg/L) | Single analyst precision, s _i ² (µg/L) | Overall precision, S' (µg/L) |
|----------------------------|----------------------------------|--|------------------------------|
| Nitrobenzene | 1.09C – 3.05 | 0.19X̄=0.92 | 0.27X̄=0.21 |
| N-Nitrosodi-n-propylamine | 1.12C – 6.22 | 0.27X̄=0.68 | 0.44X̄=0.47 |
| PCB-1260 | 0.81C – 10.86 | 0.35X̄=3.61 | 0.43X̄=1.82 |
| Phenanthrene | 0.87C – 0.06 | 0.12X̄=0.57 | 0.15X̄=0.25 |
| Pyrene | 0.84C – 0.16 | 0.16X̄=0.06 | 0.15X̄=0.31 |
| 1,2,4-Trichlorobenzene | 0.94C – 0.79 | 0.15X̄=0.85 | 0.21X̄=0.39 |
| 4-Chloro-3-methylphenol | 0.84C=0.35 | 0.23X̄=0.75 | 0.29X̄=1.31 |
| 2-Chlorophenol | 0.78C=0.29 | 0.18X̄=1.46 | 0.28X̄=0.97 |
| 2,4-Dichlorophenol | 0.87C=0.13 | 0.15X̄=1.25 | 0.21X̄=1.28 |
| 2,4-Dimethylphenol | 0.71C=4.41 | 0.16X̄=1.21 | 0.22X̄=1.31 |
| 2,4-Dinitrophenol | 0.81C – 18.04 | 0.38X̄=2.36 | 0.42X̄=26.29 |
| 2-Methyl-4,6-Dinitrophenol | 1.04C – 28.04 | 0.05X̄=42.29 | 0.26X̄=23.10 |
| 2-Nitrophenol | 1.07C – 1.15 | 0.16X̄=1.94 | 0.27X̄=2.60 |
| 4-Nitrophenol | 0.61C – 1.22 | 0.38X̄=2.57 | 0.44X̄=3.24 |
| Pentachlorophenol | 0.93C=1.99 | 0.24X̄=3.03 | 0.30X̄=4.33 |
| Phenol | 0.43C=1.26 | 0.26X̄=0.73 | 0.35X̄=0.58 |
| 2,4,6-Trichlorophenol | 0.91C – 0.18 | 0.16X̄=2.22 | 0.22X̄=1.81 |

X' = Expected recovery for one or more measurements of a sample containing a concentration of C, in µg/L.
 s_i² = Expected single analyst standard deviation of measurements at an average concentration found of X, in µg/L.
 S' = Expected interlaboratory standard deviation of measurements at an average concentration found of X, in µg/L.
 C = True value for the concentration, in µg/L.
 X̄ = Average recovery found for measurements of samples containing a concentration of C, in µg/L.
^a The proper chemical name is 2,2'-oxybis(1-chloropropane).

TABLE 8—SUGGESTED INTERNAL AND SURROGATE STANDARDS

| Base/neutral fraction | Acid fraction |
|------------------------------------|---------------------------|
| Aniline-d ₅ | 2-Fluorophenol. |
| Anthracene-d ₁₀ | Pentafluorophenol. |
| Benzo(a)anthracene-d ₁₂ | Phenol-d ₅ |
| 4,4'-Dibromobiphenyl | 2-Perfluoromethyl phenol. |
| 4,4'-Dibromooctafluorobiphenyl. | |
| Decafluorobiphenyl. | |
| 2,2'-Difluorobiphenyl | |
| 4-Fluoroaniline | |
| 1-Fluoronaphthalene | |
| 2-Fluoronaphthalene | |
| Naphthalene-d ₈ | |
| Nitrobenzene-d ₅ | |
| 2,3,4,5,6-Pentafluorobiphenyl | |
| Phenanthrene-d ₁₀ | |
| Pyridine-d ₅ | |

TABLE 9—DFTPP KEY MASSES AND ABUNDANCE CRITERIA

| Mass | m/z Abundance criteria |
|------|--|
| 51 | 30–60 percent of mass 198. |
| 68 | Less than 2 percent of mass 69. |
| 70 | Less than 2 percent of mass 69. |
| 127 | 40–60 percent of mass 198. |
| 197 | Less than 1 percent of mass 198. |
| 198 | Base peak, 100 percent relative abundance. |
| 199 | 5–9 percent of mass 198. |
| 275 | 10–30 percent of mass 198. |
| 365 | Greater than 1 percent of mass 198. |
| 441 | Present but less than mass 443. |
| 442 | Greater than 40 percent of mass 198. |
| 443 | 17–23 percent of mass 442. |

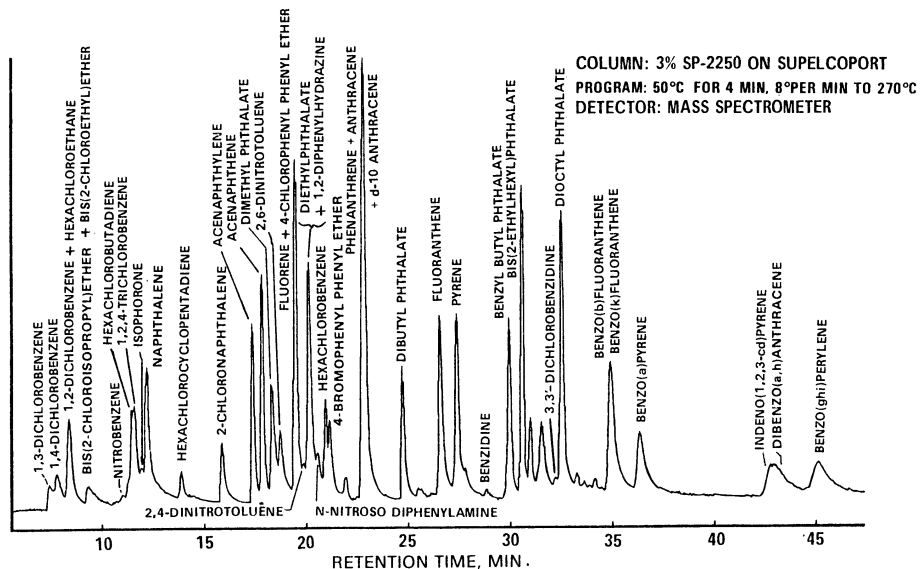

Figure 1. Gas chromatogram of base/neutral fraction .

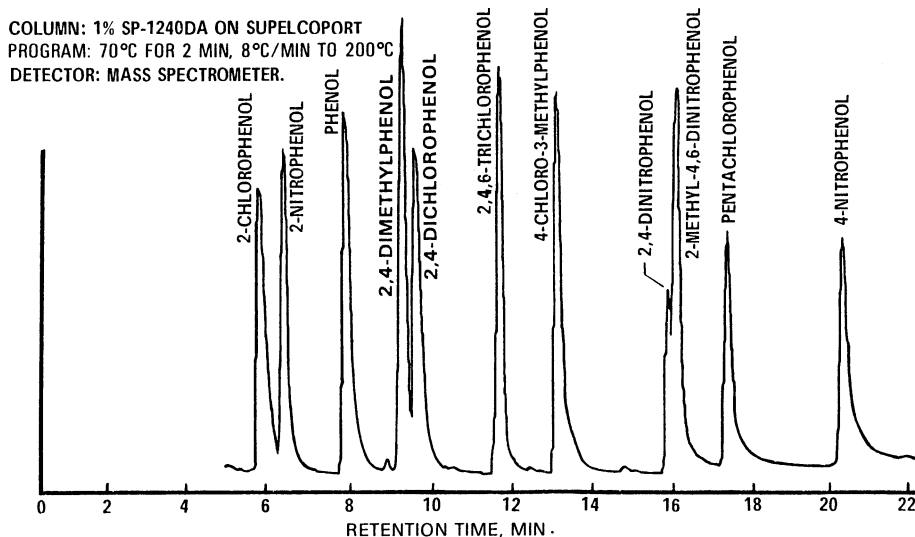

Figure 2. Gas chromatogram of acid fraction .

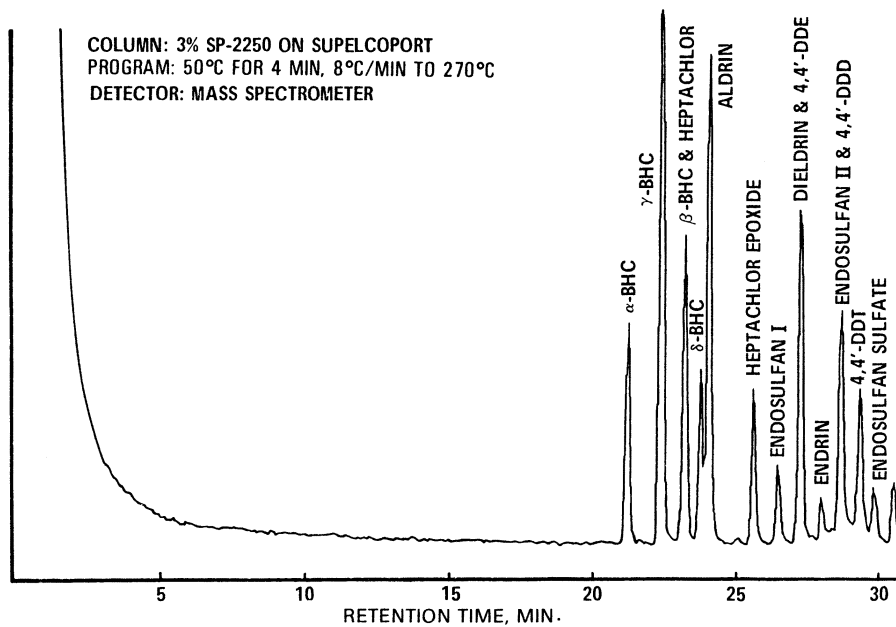

Figure 3. Gas chromatogram of pesticide fraction.

COLUMN: 3% SP-2250 ON SUPELCOPORT
PROGRAM: 50°C FOR 4 MIN, 8°C/MIN TO 270°C
DETECTOR: MASS SPECTROMETER

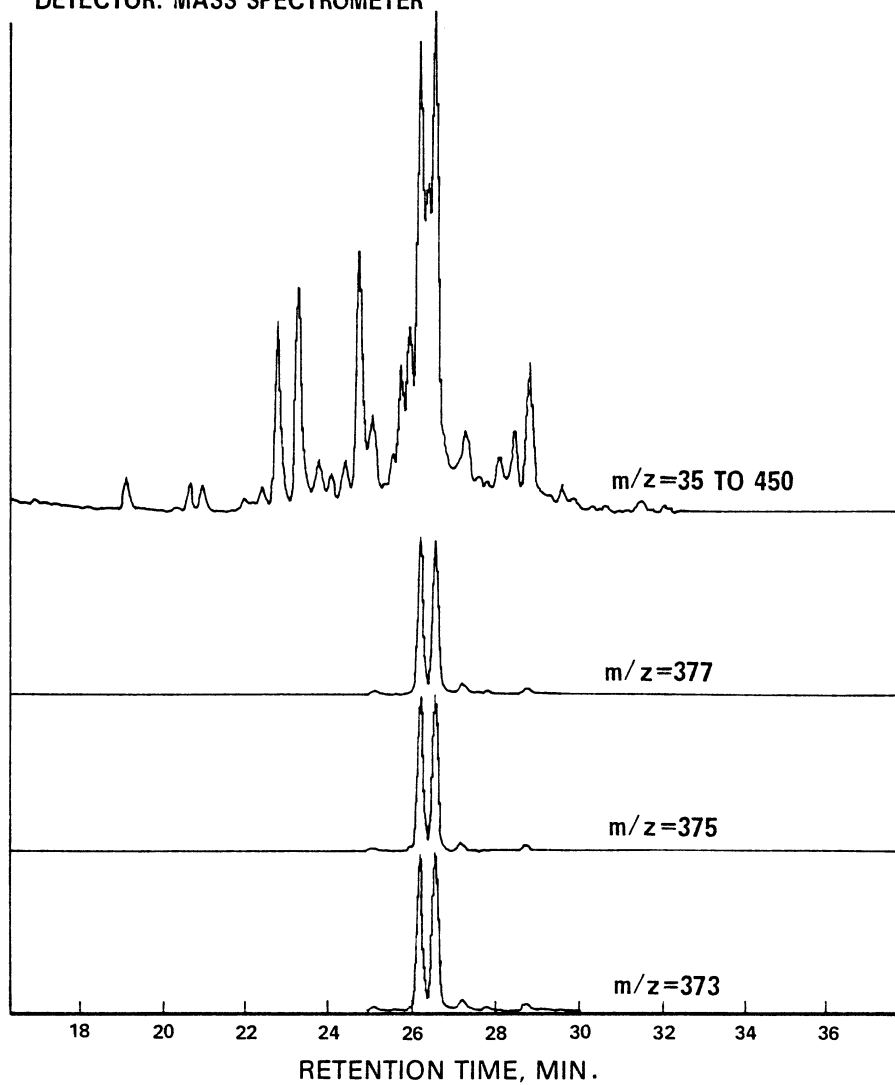

Figure 4. Gas chromatogram of chlordane.

COLUMN: 3% SP-2250 ON SUPELCOPORT
PROGRAM: 50°C FOR 4 MIN, 8°C/MIN TO 270°C
DETECTOR: MASS SPECTROMETER

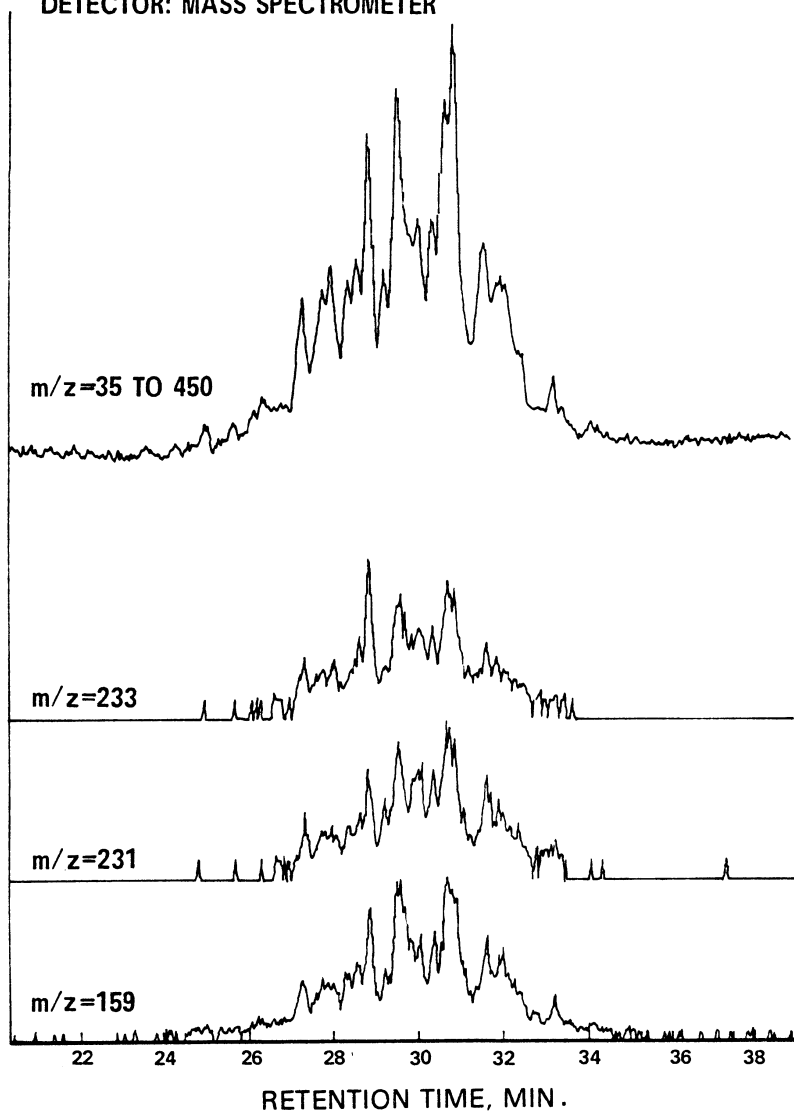

Figure 5. Gas chromatogram of toxaphene.

COLUMN: 3% SP-2250 ON SUPELCOPORT
PROGRAM: 50°C FOR 4 MIN, 8°C/MIN TO 270°C
DETECTOR: MASS SPECTROMETER

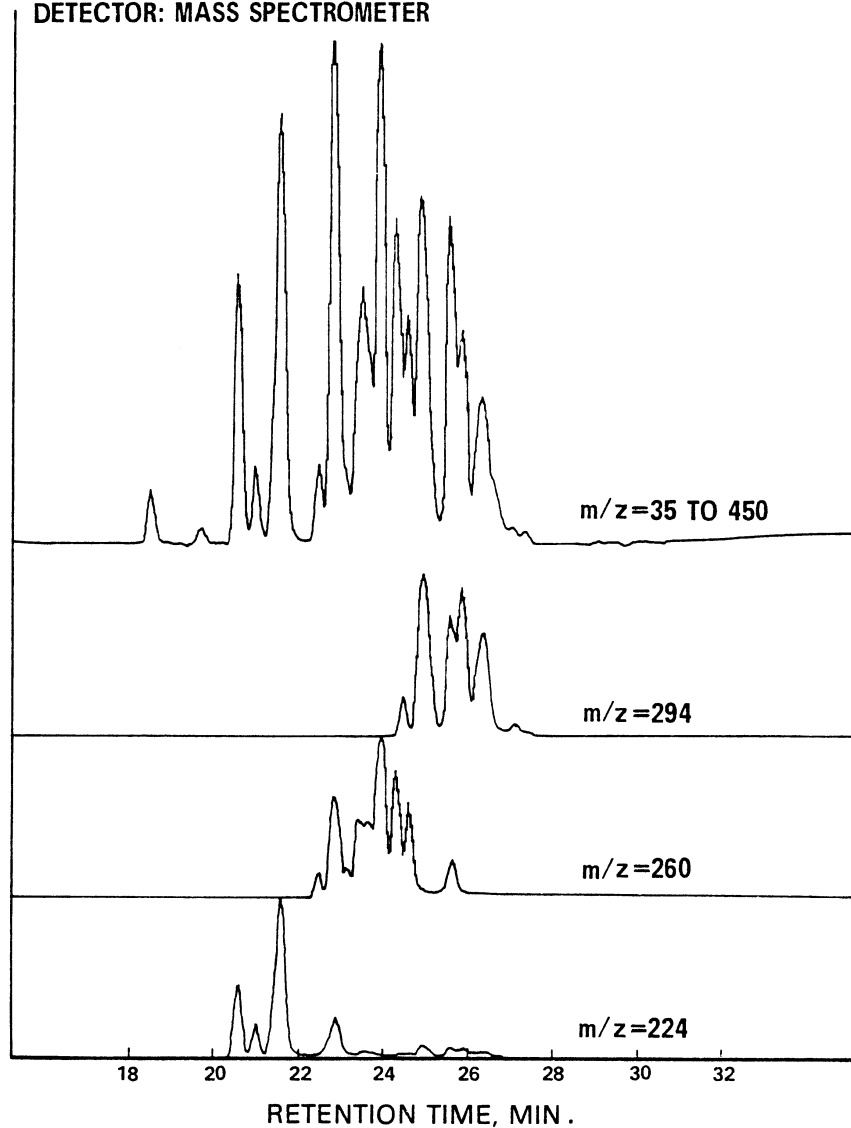

Figure 6. Gas chromatogram of PCB-1016.

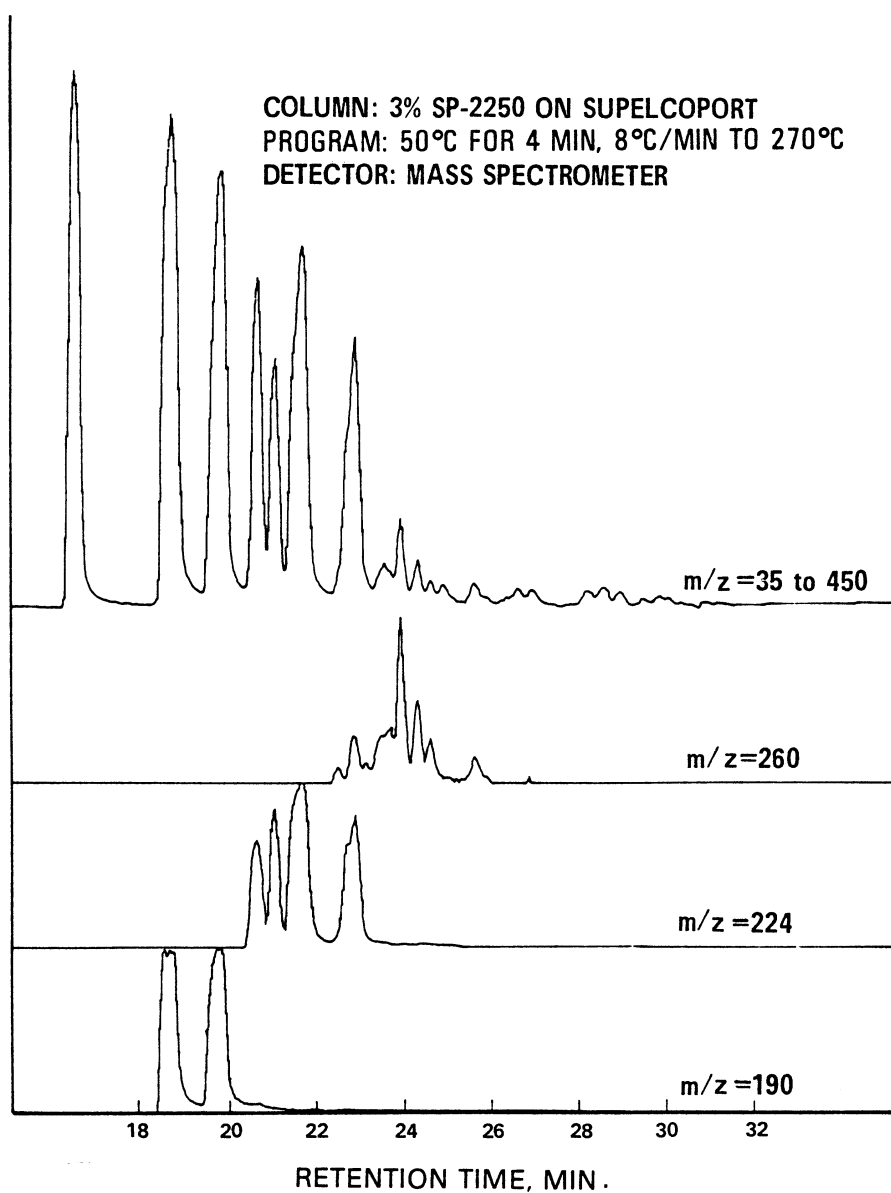

Figure 7. Gas chromatogram of PCB-1221.

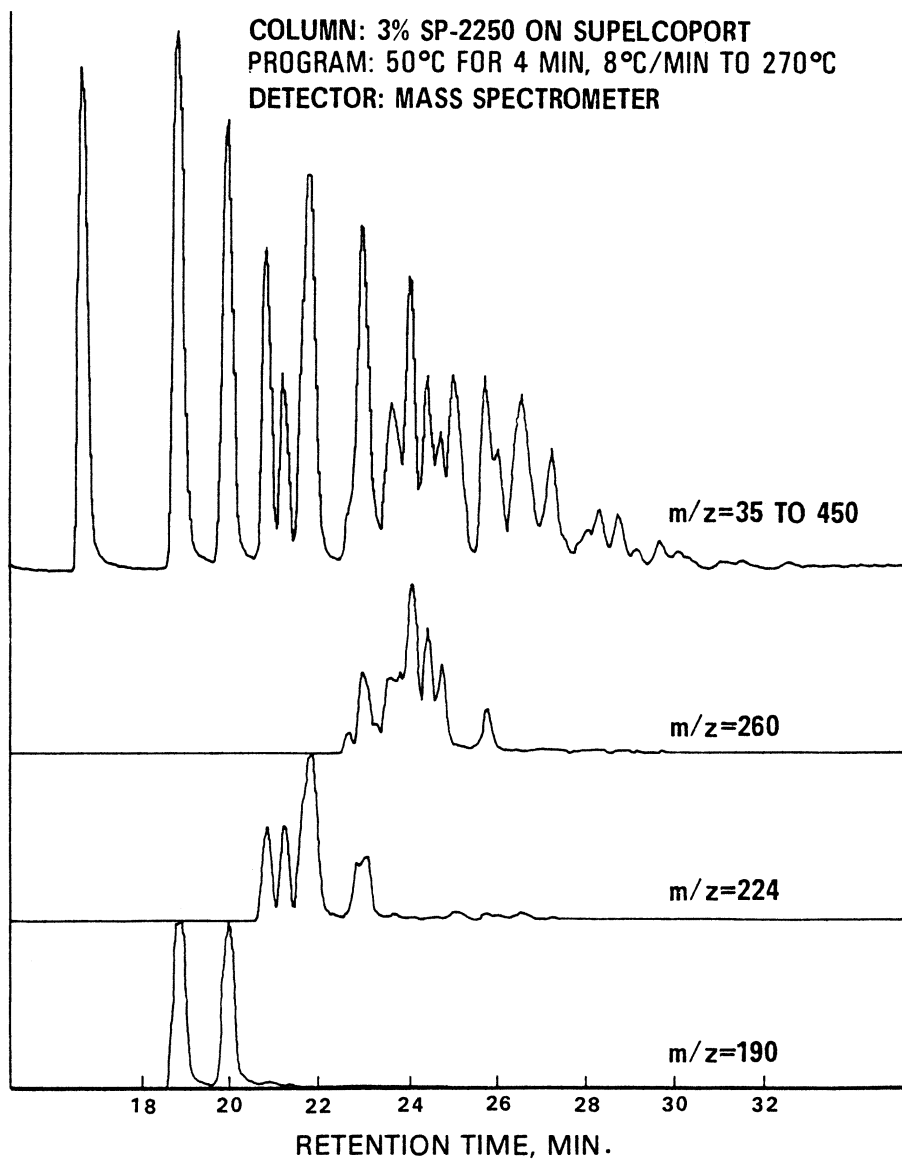

Figure 8. Gas chromatogram of PCB-1232.

COLUMN: 3% SP-2250 ON SUPELCOPORT
PROGRAM: 50°C FOR 4 MIN, 8°C/MIN TO 270°C
DETECTOR: MASS SPECTROMETER

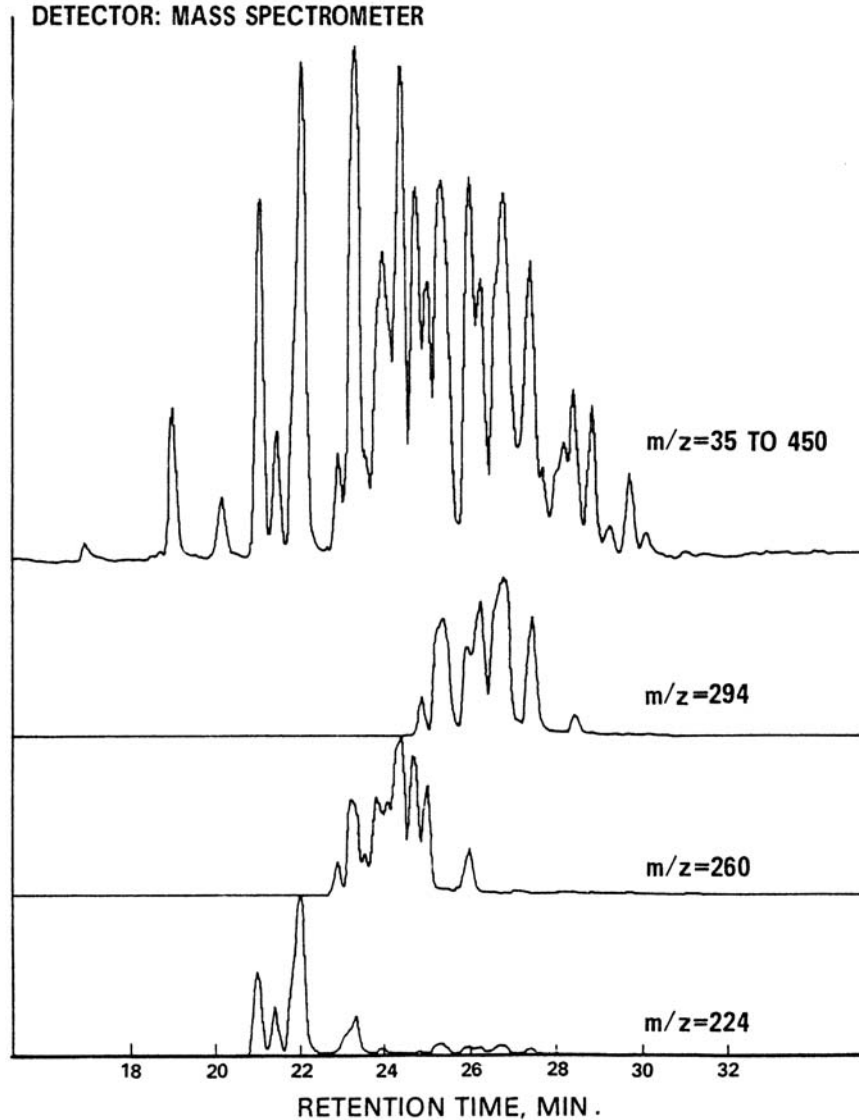

Figure 9. Gas chromatogram of PCB-1242.

COLUMN: 3% SP-2250 ON SUPELCOPORT
PROGRAM: 50°C FOR 4 MIN, 8°C/MIN TO 270°C
DETECTOR: MASS SPECTROMETER

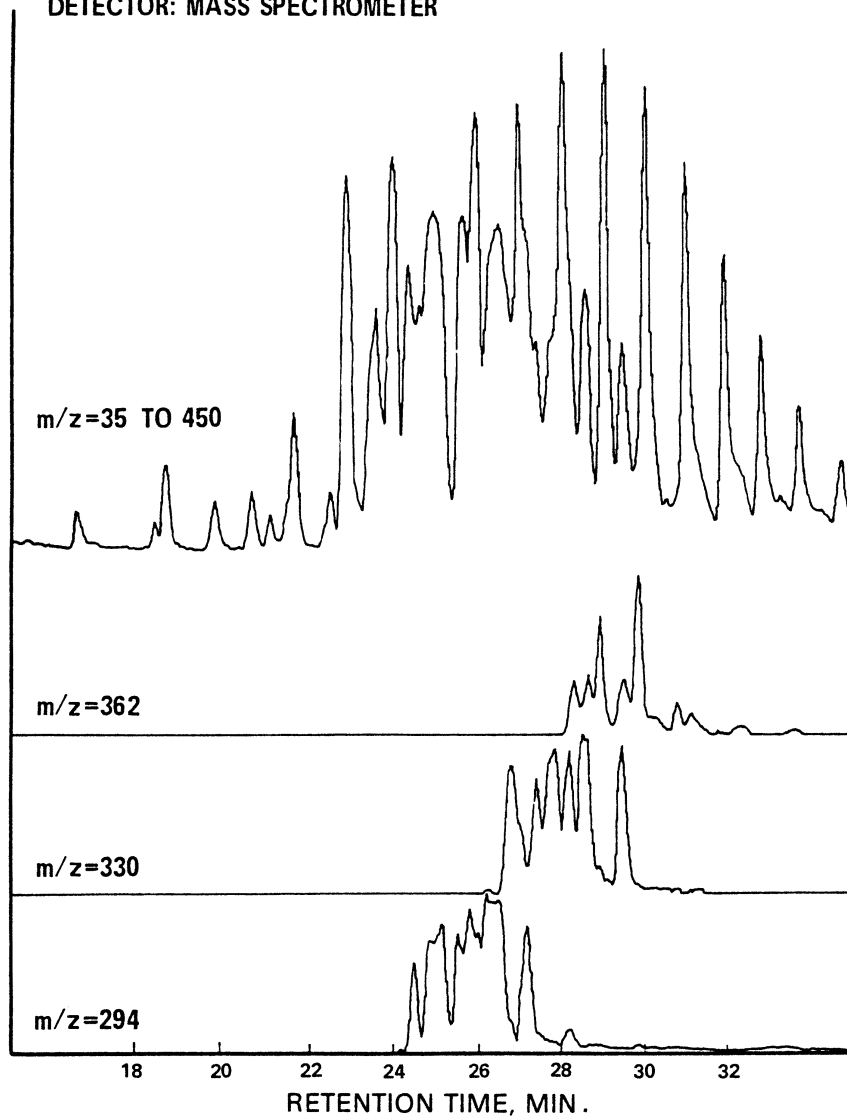

Figure 10. Gas chromatogram of PCB-1248.

COLUMN: 3% SP-2250 ON SUPELCOPORT
PROGRAM: 50°C FOR 4 MIN, 8°C/MIN TO 270°C
DETECTOR: MASS SPECTROMETER

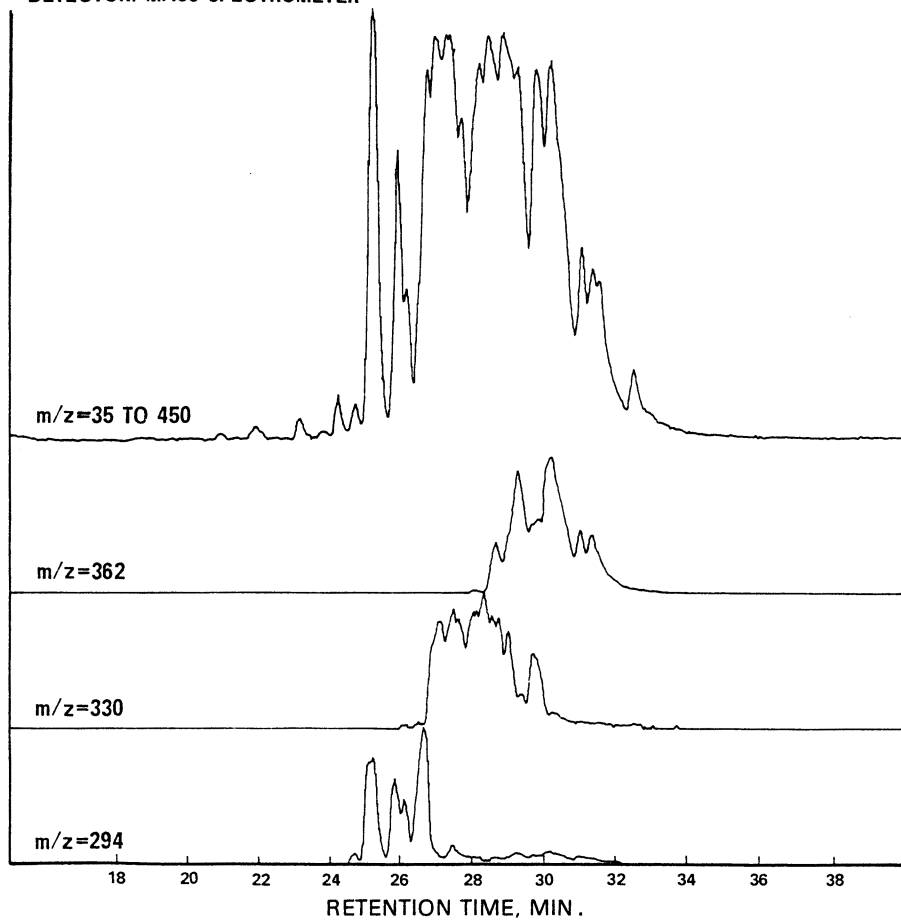

Figure 11. Gas chromatogram of PCB-1254.

COLUMN: 3% SP-2250 ON SUPELCOPORT
PROGRAM: 50°C FOR 4 MIN, 8°C/MIN TO 270°C
DETECTOR: MASS SPECTROMETER

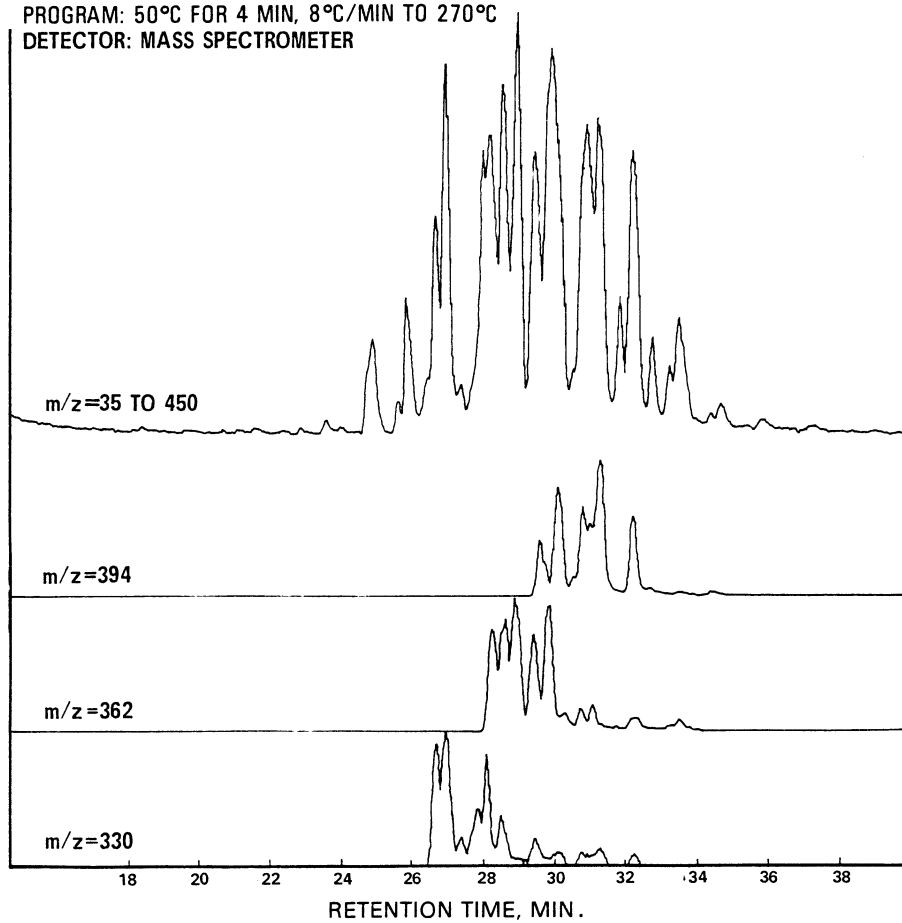
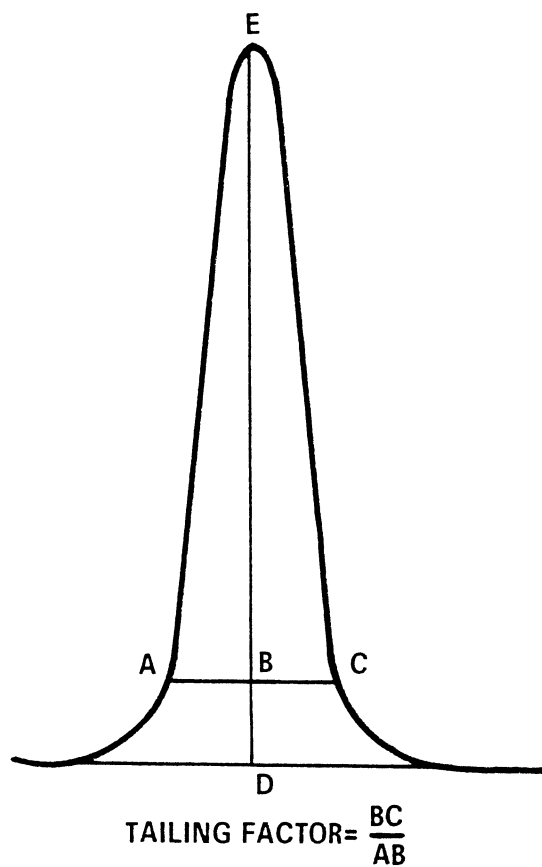

Figure 12. Gas chromatogram of PCB-1260.



Example calculation: Peak Height = DE = 100 mm
10% Peak Height = BD = 10 mm
Peak Width at 10% Peak Height = AC = 23 mm
AB = 11 mm
BC = 12 mm

Therefore: Tailing Factor = $\frac{12}{11} = 1.1$

Figure 13. Tailing factor calculation.

ATTACHMENT 1 TO METHOD 625

INTRODUCTION

To support measurement of several semivolatile pollutants, EPA has developed this attachment to EPA Method 625.¹ The modifications listed in this attachment are approved only for monitoring wastestreams from the Centralized Waste Treatment Point Source Category (40 CFR Part 437) and the Landfills Point Source Category (40 CFR Part 445). EPA Method 625 (the Method) involves sample extraction with methylene chloride followed by analysis of the extract using either packed or capillary column gas chromatography/mass spectrometry (GC/MS). This attachment addresses the addition of the semivolatile pollutants listed in Tables 1 and 2, to all applicable standard, stock, and spiking solutions utilized for the determination of semivolatile organic compounds by EPA Method 625.

1.0 EPA METHOD 625 MODIFICATION SUMMARY

The additional semivolatile organic compounds listed in Tables 1 and 2 are added to all applicable calibration, spiking, and other solutions utilized in the determination of base/neutral and acid compounds by EPA Method 625. The instrument is to be calibrated with these compounds, using a capillary column, and all procedures and quality control tests stated in the Method must be performed.

2.0 SECTION MODIFICATIONS

NOTE: All section and figure numbers in this Attachment reference section and figure numbers in EPA Method 625 unless noted otherwise. Sections not listed here remain unchanged.

Section 6.7 The stock standard solutions described in this section are modified such that the analytes in Tables 1 and 2 of this attachment are required in addition to those specified in the Method.

Section 7.2 The calibration standards described in this section are modified to include the analytes in Tables 1 and 2 of this attachment.

Section 8.2 The precision and accuracy requirements are modified to include the analytes listed in Tables 1 and 2 of this attachment. Additional performance criteria are supplied in Table 5 of this attachment.

Section 8.3 The matrix spike is modified to include the analytes listed in Tables 1 and 2 of this attachment.

Section 8.4 The QC check standard is modified to include the analytes listed in Tables 1 and 2 of this attachment. Additional performance criteria are supplied in Table 5 of this attachment.

Section 16.0 Additional method performance information is supplied with this attachment.

TABLE 1—BASE/NEUTRAL EXTRACTABLES

| Parameter | CAS No. |
|--|----------|
| acetophenone ¹ | 98-86-2 |
| alpha-terpineol ³ | 98-55-5 |
| aniline ² | 62-53-3 |
| carbazole ¹ | 86-74-8 |
| o-cresol ¹ | 95-48-7 |
| n-decane ¹ | 124-18-5 |
| 2,3-dichloroaniline ¹ | 608-27-5 |
| n-octadecane ¹ | 593-45-3 |
| pyridine ² | 110-86-1 |

CAS = Chemical Abstracts Registry.

¹ Analysis of this pollutant is approved only for the Centralized Waste Treatment industry.

² Analysis of this pollutant is approved only for the Centralized Waste Treatment and Landfills industries.

³ Analysis of this pollutant is approved only for the Landfills industry.

TABLE 2—ACID EXTRACTABLES

| Parameter | CAS No. |
|-----------------------------|----------|
| p-cresol ¹ | 106-44-5 |

CAS = Chemical Abstracts Registry.

¹ Analysis of this pollutant is approved only for the Centralized Waste Treatment and Landfills industries.

TABLE 3—CHROMATOGRAPHIC CONDITIONS,¹ METHOD DETECTION LIMITS (MDLS), AND CHARACTERISTIC M/Z'S FOR BASE/NEUTRAL EXTRACTABLES

| Analyte | Retention time (min) ² | MDL (µg/L) | Characteristic m/z's | | |
|-------------------------------|-----------------------------------|------------|----------------------|-----------|-----------|
| | | | Electron impact | | |
| | | | Primary | Secondary | Secondary |
| pyridine ³ | 4.93 | 4.6 | 79 | 52 | 51 |
| N-Nitro sodimethylamine | 4.95 | | 42 | 74 | 44 |
| aniline ³ | 10.82 | 3.3 | 93 | 66 | 65 |
| Bis(2-chloroethyl)ether | 10.94 | | 93 | 63 | 95 |
| n-decane ⁴ | 11.11 | 5.0 | 57 | | |
| 1,3-Dichlorobenzene | 11.47 | | 146 | 148 | 113 |
| 1,4-Dichlorobenzene | 11.62 | | 146 | 148 | 113 |
| 1,2-Dichlorobenzene | 12.17 | | 146 | 148 | 113 |

¹EPA Method 625: Base/Neutrals and Acids, 40 CFR Part 136, Appendix A.

TABLE 3—CHROMATOGRAPHIC CONDITIONS, ¹ METHOD DETECTION LIMITS (MDLs), AND CHARACTERISTIC M/Z'S FOR BASE/NEUTRAL EXTRACTABLES—Continued

| Analyte | Retention time (min) ² | MDL (µg/L) | Characteristic m/z's | | |
|----------------------------------|-----------------------------------|------------|----------------------|-----------|-----------|
| | | | Electron impact | | |
| | | | Primary | Secondary | Secondary |
| o-creso ¹ | 12.48 | 4.7 | 108 | 107 | 79 |
| Bis(2-chloro- isopropyl)ether | 12.51 | | 45 | 77 | 79 |
| acetophenone ⁴ | 12.88 | 3.4 | 105 | 77 | 51 |
| N-Nitrosodi-n-propylamine | 12.97 | | 130 | 42 | 101 |
| Hexachloroethane | 13.08 | | 117 | 201 | 199 |
| Nitrobenzene | 13.40 | | 77 | 123 | 65 |
| Isophorone | 14.11 | | 82 | 95 | 138 |
| Bis (2-chloro ethoxy)methane | 14.82 | | 93 | 95 | 123 |
| 1,2,4-Trichlorobenzene | 15.37 | | 180 | 182 | 145 |
| alpha-terpineol | 15.55 | 5.0 | 59 | | |
| Naphthalene | 15.56 | | 128 | 129 | 127 |
| Hexachlorobutadiene | 16.12 | | 225 | 223 | 227 |
| Hexachlorocyclopentadiene | 18.47 | | 237 | 235 | 272 |
| 2,3-dichloroaniline ⁴ | 18.82 | 2.5 | 161 | 163 | 90 |
| 2-Chloronaphthalene | 19.35 | | 162 | 164 | 127 |
| Dimethyl phthalate | 20.48 | | 163 | 194 | 164 |
| Acenaphthylene | 20.69 | | 152 | 151 | 153 |
| 2,6-Dinitrotoluene | 20.73 | | 165 | 89 | 121 |
| Acenaphthene | 21.30 | | 154 | 153 | 152 |
| 2,4-Dinitrotoluene | 22.00 | | 165 | 63 | 182 |
| Diethylphthalate | 22.74 | | 149 | 177 | 150 |
| 4-Chlorophenyl phenyl ether | 22.90 | | 204 | 206 | 141 |
| Fluorene | 22.92 | | 166 | 165 | 167 |
| N-Nitro sodiphenylamine | 23.35 | | 169 | 168 | 167 |
| 4-Bromophenyl phenyl ether | 24.44 | | 248 | 250 | 141 |
| Hexachlorobenzene | 24.93 | | 284 | 142 | 249 |
| n-octadecane ⁴ | 25.39 | 2.0 | 57 | | |
| Phenanthrene | 25.98 | | 178 | 179 | 176 |
| Anthracene | 26.12 | | 178 | 179 | 176 |
| Carbazole ⁴ | 26.66 | 4.0 | 167 | | |
| Dibutyl phthalate | 27.84 | | 149 | 150 | 104 |
| Fluoranthene | 29.82 | | 202 | 101 | 100 |
| Benzidine | 30.26 | | 184 | 92 | 185 |
| Pyrene | 30.56 | | 202 | 101 | 100 |
| Butyl benzyl phthalate | 32.63 | | 149 | 91 | 206 |
| 3,3'-Dichlorobenzidine | 34.28 | | 252 | 254 | 126 |
| Benzo(a)anthracene | 34.33 | | 228 | 229 | 226 |
| Bis(2-ethyl hexyl)phthalate | 34.36 | | 149 | 167 | 279 |
| Chrysene | 34.44 | | 228 | 226 | 229 |
| Di-n-octyl-phthalate | 36.17 | | 149 | | |
| Benzo(b)fluoranthene | 37.90 | | 252 | 253 | 125 |
| Benzo(k)fluoranthene | 37.97 | | 252 | 253 | 125 |
| Benzo(a)pyrene | 39.17 | | 252 | 253 | 125 |
| Dibenzo(a,h) anthracene | 44.91 | | 278 | 139 | 279 |
| Indeno(1,2,3-c,d)pyrene | 45.01 | | 276 | 138 | 277 |
| Benzo(ghi)perylene | 46.56 | | 276 | 138 | 277 |

¹ The data presented in this table were obtained under the following conditions:
 Column—30 ± 5 meters × 0.25 ± 0.02 mm i.d., 94% methyl, 5% phenyl, 1% vinyl, bonded phase fused silica capillary column (DB-5).
 Temperature program—Five minutes at 30 °C; 30–280 °C at 8 °C per minute; isothermal at 280 °C until benzo(ghi)perylene elutes.
 Gas velocity—30 ± 5 cm/sec at 30 °C.
² Retention times are from Method 1625, Revision C, using a capillary column, and are intended to be consistent for all analytes in Tables 4 and 5 of this attachment.
³ Analysis of this pollutant is approved only for the Centralized Waste Treatment and Landfills industries.
⁴ Analysis of this pollutant is approved only for the Centralized Waste Treatment industry.

TABLE 4—CHROMATOGRAPHIC CONDITIONS, ¹ METHOD DETECTION LIMITS (MDLs), AND CHARACTERISTIC M/Z'S FOR ACID EXTRACTABLES

| Analyte | Retention time ² (min) | MDL (µg/L) | Characteristic m/z's | | |
|----------------|-----------------------------------|------------|----------------------|-----------|-----------|
| | | | Electron impact | | |
| | | | Primary | Secondary | Secondary |
| Phenol | 10.76 | | 94 | 65 | 66 |
| 2-Chlorophenol | 11.08 | | 128 | 64 | 130 |

TABLE 4—CHROMATOGRAPHIC CONDITIONS, ¹ METHOD DETECTION LIMITS (MDLs), AND CHARACTERISTIC M/Z'S FOR ACID EXTRACTABLES—Continued

| Analyte | Retention time ² (min) | MDL (µg/L) | Characteristic m/z's | | |
|----------------------------|-----------------------------------|------------|----------------------|-----------|-----------|
| | | | Electron impact | | |
| | | | Primary | Secondary | Secondary |
| p-cresol ³ | 12.92 | 7.8 | 108 | 107 | 77 |
| 2-Nitrophenol | 14.38 | | 139 | 65 | 109 |
| 2,4-Dimethylphenol | 14.54 | | 122 | 107 | 121 |
| 2,4-Dichlorophenol | 15.12 | | 162 | 164 | 98 |
| 4-Chloro-3-methylphenol | 16.83 | | 142 | 107 | 144 |
| 2,4,6-Trichlorophenol | 18.80 | | 196 | 198 | 200 |
| 2,4-Dinitrophenol | 21.51 | | 184 | 63 | 154 |
| 4-Nitrophenol | 21.77 | | 65 | 139 | 109 |
| 2-Methyl-4,6-dinitrophenol | 22.83 | | 198 | 182 | 77 |
| Pentachlorophenol | 25.52 | | 266 | 264 | 268 |

¹ The data presented in this table were obtained under the following conditions:
 Column—30 ± 5 meters × 0.25 ± 0.02 mm i.d., 94% methyl, 5% phenyl, 1% vinyl silicone bonded phase fused silica capillary column (DB-5).

Temperature program—Five minutes at 30 °C; 30–280 °C at 8 °C per minute; isothermal at 280 °C until benzo(ghi)perylene elutes.

Gas velocity—30 ± 5 cm/sec at 30 °C

² Retention times are from EPA Method 1625, Revision C, using a capillary column, and are intended to be consistent for all analytes in Tables 3 and 4 of this attachment.

³ Analysis of this pollutant is approved only for the Centralized Waste Treatment and Landfills industries.

TABLE 5—QC ACCEPTANCE CRITERIA

| Analyte | Test conclusion (µg/L) | Limits for s (µg/L) | Range for X (µg/L) | Range for P, P _s (%) |
|----------------------------------|------------------------|---------------------|--------------------|---------------------------------|
| acetophenone ¹ | 100 | 51 | 23–254 | 61–144 |
| alpha-terpineol | 100 | 47 | 46–163 | 58–156 |
| aniline ² | 100 | 71 | 15–278 | 46–134 |
| carbazole ¹ | 100 | 17 | 79–111 | 73–131 |
| o-cresol ¹ | 100 | 23 | 30–146 | 55–126 |
| p-cresol ² | 100 | 22 | 11–617 | 76–107 |
| n-decane ¹ | 100 | 70 | D–651 | D-ns |
| 2,3-dichloroaniline ¹ | 100 | 13 | 40–160 | 68–134 |
| n-octadecane ¹ | 100 | 10 | 52–147 | 65–123 |
| pyridine ² | 100 | ns | 7–392 | 33–158 |

s = Standard deviation for four recovery measurements, in µg/L (Section 8.2)

X = Average recovery for four recovery measurements in µg/L (Section 8.2)

P, P_s = Percent recovery measured (Section 8.3, Section 8.4)

D = Detected; result must be greater than zero.

ns = no specification; limit is outside the range that can be measured reliably.

¹ Analysis of this pollutant is approved only for the Centralized Waste Treatment industry.

² Analysis of this pollutant is approved only for the Centralized Waste Treatment and Landfills industries.

METHOD 1613, REVISION B

Tetra- Through Octa-Chlorinated Dioxins and Furans by Isotope Dilution HRGC/HRMS

1.0 Scope and Application

1.1 This method is for determination of tetra- through octa-chlorinated dibenzo-p-dioxins (CDDs) and dibenzofurans (CDFs) in water, soil, sediment, sludge, tissue, and other sample matrices by high resolution gas chromatography/high resolution mass spectrometry (HRGC/HRMS). The method is for use in EPA's data gathering and monitoring programs associated with the Clean Water Act, the Resource Conservation and Recovery Act, the Comprehensive Environmental Response, Compensation and Liability Act, and the Safe Drinking Water Act. The meth-

od is based on a compilation of EPA, industry, commercial laboratory, and academic methods (References 1–6).

1.2 The seventeen 2,3,7,8-substituted CDDs/CDFs listed in Table 1 may be determined by this method. Specifications are also provided for separate determination of 2,3,7,8-tetrachloro-dibenzo-p-dioxin (2,3,7,8-TCDD) and 2,3,7,8-tetrachloro-dibenzofuran (2,3,7,8-TCDF).

1.3 The detection limits and quantitation levels in this method are usually dependent on the level of interferences rather than instrumental limitations. The minimum levels (MLs) in Table 2 are the levels at which the CDDs/CDFs can be determined with no interferences present. The Method Detection

Limit (MDL) for 2,3,7,8-TCDD has been determined as 4.4 pg/L (parts-per-quadrillion) using this method.

1.4 The GC/MS portions of this method are for use only by analysts experienced with HRGC/HRMS or under the close supervision of such qualified persons. Each laboratory that uses this method must demonstrate the ability to generate acceptable results using the procedure in Section 9.2.

1.5 This method is "performance-based". The analyst is permitted to modify the method to overcome interferences or lower the cost of measurements, provided that all performance criteria in this method are met. The requirements for establishing method equivalency are given in Section 9.1.2.

1.6 Any modification of this method, beyond those expressly permitted, shall be considered a major modification subject to application and approval of alternate test procedures under 40 CFR 136.4 and 136.5.

2.0 Summary of Method

Flow charts that summarize procedures for sample preparation, extraction, and analysis are given in Figure 1 for aqueous and solid samples, Figure 2 for multi-phase samples, and Figure 3 for tissue samples.

2.1 Extraction.

2.1.1 Aqueous samples (samples containing less than 1% solids)—Stable isotopically labeled analogs of 15 of the 2,3,7,8-substituted CDDs/CDFs are spiked into a 1 L sample, and the sample is extracted by one of three procedures:

2.1.1.1 Samples containing no visible particles are extracted with methylene chloride in a separatory funnel or by the solid-phase extraction technique summarized in Section 2.1.1.3. The extract is concentrated for cleanup.

2.1.1.2 Samples containing visible particles are vacuum filtered through a glass-fiber filter. The filter is extracted in a Soxhlet/Dean-Stark (SDS) extractor (Reference 7), and the filtrate is extracted with methylene chloride in a separatory funnel. The methylene chloride extract is concentrated and combined with the SDS extract prior to cleanup.

2.1.1.3 The sample is vacuum filtered through a glass-fiber filter on top of a solid-phase extraction (SPE) disk. The filter and disk are extracted in an SDS extractor, and the extract is concentrated for cleanup.

2.1.2 Solid, semi-solid, and multi-phase samples (but not tissue)—The labeled compounds are spiked into a sample containing 10 g (dry weight) of solids. Samples containing multiple phases are pressure filtered and any aqueous liquid is discarded. Coarse solids are ground or homogenized. Any non-aqueous liquid from multi-phase samples is combined with the solids and extracted in an SDS extractor. The extract is concentrated for cleanup.

2.1.3 Fish and other tissue—The sample is extracted by one of two procedures:

2.1.3.1 Soxhlet or SDS extraction—A 20 g aliquot of sample is homogenized, and a 10 g aliquot is spiked with the labeled compounds. The sample is mixed with sodium sulfate, allowed to dry for 12–24 hours, and extracted for 18–24 hours using methylene chloride:hexane (1:1) in a Soxhlet extractor. The extract is evaporated to dryness, and the lipid content is determined.

2.1.3.2 HCl digestion—A 20 g aliquot is homogenized, and a 10 g aliquot is placed in a bottle and spiked with the labeled compounds. After equilibration, 200 mL of hydrochloric acid and 200 mL of methylene chloride:hexane (1:1) are added, and the bottle is agitated for 12–24 hours. The extract is evaporated to dryness, and the lipid content is determined.

2.2 After extraction, $^{37}\text{Cl}_4$ -labeled 2,3,7,8-TCDD is added to each extract to measure the efficiency of the cleanup process. Sample cleanups may include back-extraction with acid and/or base, and gel permeation, alumina, silica gel, Florisil and activated carbon chromatography. High-performance liquid chromatography (HPLC) can be used for further isolation of the 2,3,7,8-isomers or other specific isomers or congeners. Prior to the cleanup procedures cited above, tissue extracts are cleaned up using an anthropogenic isolation column, a batch silica gel adsorption, or sulfuric acid and base back-extraction, depending on the tissue extraction procedure used.

2.3 After cleanup, the extract is concentrated to near dryness. Immediately prior to injection, internal standards are added to each extract, and an aliquot of the extract is injected into the gas chromatograph. The analytes are separated by the GC and detected by a high-resolution ($\geq 10,000$) mass spectrometer. Two exact m/z 's are monitored for each analyte.

2.4 An individual CDD/CDF is identified by comparing the GC retention time and ion-abundance ratio of two exact m/z 's with the corresponding retention time of an authentic standard and the theoretical or acquired ion-abundance ratio of the two exact m/z 's. The non-2,3,7,8 substituted isomers and congeners are identified when retention times and ion-abundance ratios agree within predefined limits. Isomer specificity for 2,3,7,8-TCDD and 2,3,7,8-TCDF is achieved using GC columns that resolve these isomers from the other tetra-isomers.

2.5 Quantitative analysis is performed using selected ion current profile (SICP) areas, in one of three ways:

2.5.1 For the 15 2,3,7,8-substituted CDDs/CDFs with labeled analogs (see Table 1), the GC/MS system is calibrated, and the concentration of each compound is determined using the isotope dilution technique.

2.5.2 For 1,2,3,7,8,9-HxCDD, OCDF, and the labeled compounds, the GC/MS system is calibrated and the concentration of each compound is determined using the internal standard technique.

2.5.3 For non-2,3,7,8-substituted isomers and for all isomers at a given level of chlorination (*i.e.*, total TCDD), concentrations are determined using response factors from calibration of the CDDs/CDFs at the same level of chlorination.

2.6 The quality of the analysis is assured through reproducible calibration and testing of the extraction, cleanup, and GC/MS systems.

3.0 Definitions

Definitions are given in the glossary at the end of this method.

4.0 Contamination and Interferences

4.1 Solvents, reagents, glassware, and other sample processing hardware may yield artifacts and/or elevated baselines causing misinterpretation of chromatograms (References 8-9). Specific selection of reagents and purification of solvents by distillation in all-glass systems may be required. Where possible, reagents are cleaned by extraction or solvent rinse.

4.2 Proper cleaning of glassware is extremely important, because glassware may not only contaminate the samples but may also remove the analytes of interest by adsorption on the glass surface.

4.2.1 Glassware should be rinsed with solvent and washed with a detergent solution as soon after use as is practical. Sonication of glassware containing a detergent solution for approximately 30 seconds may aid in cleaning. Glassware with removable parts, particularly separatory funnels with fluoropolymer stopcocks, must be disassembled prior to detergent washing.

4.2.2 After detergent washing, glassware should be rinsed immediately, first with methanol, then with hot tap water. The tap water rinse is followed by another methanol rinse, then acetone, and then methylene chloride.

4.2.3 Do not bake reusable glassware in an oven as a routine part of cleaning. Baking may be warranted after particularly dirty samples are encountered but should be minimized, as repeated baking of glassware may cause active sites on the glass surface that will irreversibly adsorb CDDs/CDFs.

4.2.4 Immediately prior to use, the Soxhlet apparatus should be pre-extracted with toluene for approximately three hours (see Sections 12.3.1 through 12.3.3). Separatory funnels should be shaken with methylene chloride/toluene (80/20 mixture) for two minutes, drained, and then shaken with pure methylene chloride for two minutes.

4.3 All materials used in the analysis shall be demonstrated to be free from interferences by running reference matrix method blanks initially and with each sample batch (samples started through the extraction process on a given 12-hour shift, to a maximum of 20 samples).

4.3.1 The reference matrix must simulate, as closely as possible, the sample matrix under test. Ideally, the reference matrix should not contain the CDDs/CDFs in detectable amounts, but should contain potential interferents in the concentrations expected to be found in the samples to be analyzed. For example, a reference sample of human adipose tissue containing pentachloronaphthalene can be used to exercise the cleanup systems when samples containing pentachloronaphthalene are expected.

4.3.2 When a reference matrix that simulates the sample matrix under test is not available, reagent water (Section 7.6.1) can be used to simulate water samples; playground sand (Section 7.6.2) or white quartz sand (Section 7.3.2) can be used to simulate soils; filter paper (Section 7.6.3) can be used to simulate papers and similar materials; and corn oil (Section 7.6.4) can be used to simulate tissues.

4.4 Interferences coextracted from samples will vary considerably from source to source, depending on the diversity of the site being sampled. Interfering compounds may be present at concentrations several orders of magnitude higher than the CDDs/CDFs. The most frequently encountered interferences are chlorinated biphenyls, methoxy biphenyls, hydroxydiphenyl ethers, benzylphenyl ethers, polynuclear aromatics, and pesticides. Because very low levels of CDDs/CDFs are measured by this method, the elimination of interferences is essential. The cleanup steps given in Section 13 can be used to reduce or eliminate these interferences and thereby permit reliable determination of the CDDs/CDFs at the levels shown in Table 2.

4.5 Each piece of reusable glassware should be numbered to associate that glassware with the processing of a particular sample. This will assist the laboratory in tracking possible sources of contamination for individual samples, identifying glassware associated with highly contaminated samples that may require extra cleaning, and determining when glassware should be discarded.

4.6 Cleanup of tissue—The natural lipid content of tissue can interfere in the analysis of tissue samples for the CDDs/CDFs. The lipid contents of different species and portions of tissue can vary widely. Lipids are soluble to varying degrees in various organic solvents and may be present in sufficient quantity to overwhelm the column chromatographic cleanup procedures used for cleanup of sample extracts. Lipids must

be removed by the lipid removal procedures in Section 13.7, followed by alumina (Section 13.4) or Florisil (Section 13.8), and carbon (Section 13.5) as minimum additional clean-up steps. If chlorodiphenyl ethers are detected, as indicated by the presence of peaks at the exact m/z 's monitored for these interferences, alumina and/or Florisil cleanup must be employed to eliminate these interferences.

5.0 Safety

5.1 The toxicity or carcinogenicity of each compound or reagent used in this method has not been precisely determined; however, each chemical compound should be treated as a potential health hazard. Exposure to these compounds should be reduced to the lowest possible level.

5.1.1 The 2,3,7,8-TCDD isomer has been found to be acnegenic, carcinogenic, and teratogenic in laboratory animal studies. It is soluble in water to approximately 200 ppt and in organic solvents to 0.14%. On the basis of the available toxicological and physical properties of 2,3,7,8-TCDD, all of the CDDs/CDFs should be handled only by highly trained personnel thoroughly familiar with handling and cautionary procedures and the associated risks.

5.1.2 It is recommended that the laboratory purchase dilute standard solutions of the analytes in this method. However, if primary solutions are prepared, they shall be prepared in a hood, and a NIOSH/MESA approved toxic gas respirator shall be worn when high concentrations are handled.

5.2 The laboratory is responsible for maintaining a current awareness file of OSHA regulations regarding the safe handling of the chemicals specified in this method. A reference file of material safety data sheets (MSDSs) should also be made available to all personnel involved in these analyses. It is also suggested that the laboratory perform personal hygiene monitoring of each analyst who uses this method and that the results of this monitoring be made available to the analyst. Additional information on laboratory safety can be found in References 10-13. The references and bibliography at the end of Reference 13 are particularly comprehensive in dealing with the general subject of laboratory safety.

5.3 The CDDs/CDFs and samples suspected to contain these compounds are handled using essentially the same techniques employed in handling radioactive or infectious materials. Well-ventilated, controlled access laboratories are required. Assistance in evaluating the health hazards of particular laboratory conditions may be obtained from certain consulting laboratories and from State Departments of Health or Labor, many of which have an industrial health service. The CDDs/CDFs are extremely toxic to laboratory animals. Each laboratory must de-

velop a strict safety program for handling these compounds. The practices in References 2 and 14 are highly recommended.

5.3.1 Facility—When finely divided samples (dusts, soils, dry chemicals) are handled, all operations (including removal of samples from sample containers, weighing, transferring, and mixing) should be performed in a glove box demonstrated to be leak tight or in a fume hood demonstrated to have adequate air flow. Gross losses to the laboratory ventilation system must not be allowed. Handling of the dilute solutions normally used in analytical and animal work presents no inhalation hazards except in the case of an accident.

5.3.2 Protective equipment—Disposable plastic gloves, apron or lab coat, safety glasses or mask, and a glove box or fume hood adequate for radioactive work should be used. During analytical operations that may give rise to aerosols or dusts, personnel should wear respirators equipped with activated carbon filters. Eye protection equipment (preferably full face shields) must be worn while working with exposed samples or pure analytical standards. Latex gloves are commonly used to reduce exposure of the hands. When handling samples suspected or known to contain high concentrations of the CDDs/CDFs, an additional set of gloves can also be worn beneath the latex gloves.

5.3.3 Training—Workers must be trained in the proper method of removing contaminated gloves and clothing without contacting the exterior surfaces.

5.3.4 Personal hygiene—Hands and forearms should be washed thoroughly after each manipulation and before breaks (coffee, lunch, and shift).

5.3.5 Confinement—Isolated work areas posted with signs, segregated glassware and tools, and plastic absorbent paper on bench tops will aid in confining contamination.

5.3.6 Effluent vapors—The effluents of sample splitters from the gas chromatograph (GC) and from roughing pumps on the mass spectrometer (MS) should pass through either a column of activated charcoal or be bubbled through a trap containing oil or high-boiling alcohols to condense CDD/CDF vapors.

5.3.7 Waste Handling—Good technique includes minimizing contaminated waste. Plastic bag liners should be used in waste cans. Janitors and other personnel must be trained in the safe handling of waste.

5.3.8 Decontamination

5.3.8.1 Decontamination of personnel—Use any mild soap with plenty of scrubbing action.

5.3.8.2 Glassware, tools, and surfaces—Chlorothene NU Solvent is the least toxic solvent shown to be effective. Satisfactory cleaning may be accomplished by rinsing with Chlorothene, then washing with any detergent and water. If glassware is first rinsed

with solvent, then the dish water may be disposed of in the sewer. Given the cost of disposal, it is prudent to minimize solvent wastes.

5.3.9 Laundry—Clothing known to be contaminated should be collected in plastic bags. Persons who convey the bags and launder the clothing should be advised of the hazard and trained in proper handling. The clothing may be put into a washer without contact if the launderer knows of the potential problem. The washer should be run through a cycle before being used again for other clothing.

5.3.10 Wipe tests—A useful method of determining cleanliness of work surfaces and tools is to wipe the surface with a piece of filter paper. Extraction and analysis by GC with an electron capture detector (ECD) can achieve a limit of detection of 0.1 µg per wipe; analysis using this method can achieve an even lower detection limit. Less than 0.1 µg per wipe indicates acceptable cleanliness; anything higher warrants further cleaning. More than 10 µg on a wipe constitutes an acute hazard and requires prompt cleaning before further use of the equipment or work space, and indicates that unacceptable work practices have been employed.

5.3.11 Table or wrist-action shaker—The use of a table or wrist-action shaker for extraction of tissues presents the possibility of breakage of the extraction bottle and spillage of acid and flammable organic solvent. A secondary containment system around the shaker is suggested to prevent the spread of acid and solvents in the event of such a breakage. The speed and intensity of shaking action should also be adjusted to minimize the possibility of breakage.

6.0 Apparatus and Materials

NOTE: Brand names, suppliers, and part numbers are for illustration purposes only and no endorsement is implied. Equivalent performance may be achieved using apparatus and materials other than those specified here. Meeting the performance requirements of this method is the responsibility of the laboratory.

6.1 Sampling Equipment for Discrete or Composite Sampling

6.1.1 Sample bottles and caps

6.1.1.1 Liquid samples (waters, sludges and similar materials containing 5% solids or less)—Sample bottle, amber glass, 1.1 L minimum, with screw cap.

6.1.1.2 Solid samples (soils, sediments, sludges, paper pulps, filter cake, compost, and similar materials that contain more than 5% solids)—Sample bottle, wide mouth, amber glass, 500 mL minimum.

6.1.1.3 If amber bottles are not available, samples shall be protected from light.

6.1.1.4 Bottle caps—Threaded to fit sample bottles. Caps shall be lined with fluoropolymer.

6.1.1.5 Cleaning

6.1.1.5.1 Bottles are detergent water washed, then solvent rinsed before use.

6.1.1.5.2 Liners are detergent water washed, rinsed with reagent water (Section 7.6.1) followed by solvent, and baked at approximately 200 °C for a minimum of 1 hour prior to use.

6.1.2 Compositing equipment—Automatic or manual compositing system incorporating glass containers cleaned per bottle cleaning procedure above. Only glass or fluoropolymer tubing shall be used. If the sampler uses a peristaltic pump, a minimum length of compressible silicone rubber tubing may be used in the pump only. Before use, the tubing shall be thoroughly rinsed with methanol, followed by repeated rinsing with reagent water to minimize sample contamination. An integrating flow meter is used to collect proportional composite samples.

6.2 Equipment for Glassware Cleaning—Laboratory sink with overhead fume hood.

6.3 Equipment for Sample Preparation

6.3.1 Laboratory fume hood of sufficient size to contain the sample preparation equipment listed below.

6.3.2 Glove box (optional).

6.3.3 Tissue homogenizer—VirTis Model 45 Macro homogenizer (American Scientific Products H-3515, or equivalent) with stainless steel Macro-shaft and Turbo-shear blade.

6.3.4 Meat grinder—Hobart, or equivalent, with 3-5 mm holes in inner plate.

6.3.5 Equipment for determining percent moisture

6.3.5.1 Oven—Capable of maintaining a temperature of 110 ± 5 °C.

6.3.5.2 Dessicator.

6.3.6 Balances

6.3.6.1 Analytical—Capable of weighing 0.1 mg.

6.3.6.2 Top loading—Capable of weighing 10 mg.

6.4 Extraction Apparatus

6.4.1 Water samples

6.4.1.1 pH meter, with combination glass electrode.

6.4.1.2 pH paper, wide range (Hydriion Papers, or equivalent).

6.4.1.3 Graduated cylinder, 1 L capacity.

6.4.1.4 Liquid/liquid extraction—Separatory funnels, 250 mL, 500 mL, and 2000 mL, with fluoropolymer stopcocks.

6.4.1.5 Solid-phase extraction

6.4.1.5.1 One liter filtration apparatus, including glass funnel, glass frit support, clamp, adapter, stopper, filtration flask, and vacuum tubing (Figure 4). For wastewater samples, the apparatus should accept 90 or 144 mm disks. For drinking water or other samples containing low solids, smaller disks may be used.

6.4.1.5.2 Vacuum source capable of maintaining 25 in. Hg, equipped with shutoff valve and vacuum gauge.

6.4.1.5.3 Glass-fiber filter—Whatman GMF 150 (or equivalent), 1 micron pore size, to fit filtration apparatus in Section 6.4.1.5.1.

6.4.1.5.4 Solid-phase extraction disk containing octadecyl (C_{18}) bonded silica uniformly enmeshed in an inert matrix—Fisher Scientific 14-378F (or equivalent), to fit filtration apparatus in Section 6.4.1.5.1.

6.4.2 Soxhlet/Dean-Stark (SDS) extractor (Figure 5)—For filters and solid/sludge samples.

6.4.2.1 Soxhlet—50 mm ID, 200 mL capacity with 500 mL flask (Cal-Glass LG-6900, or equivalent, except substitute 500 mL round-bottom flask for 300 mL flat-bottom flask).

6.4.2.2 Thimble—43 × 123 to fit Soxhlet (Cal-Glass LG-6901-122, or equivalent).

6.4.2.3 Moisture trap—Dean Stark or Barret with fluoropolymer stopcock, to fit Soxhlet.

6.4.2.4 Heating mantle—Hemispherical, to fit 500 mL round-bottom flask (Cal-Glass LG-8801-112, or equivalent).

6.4.2.5 Variable transformer—Powerstat (or equivalent), 110 volt, 10 amp.

6.4.3 Apparatus for extraction of tissue.

6.4.3.1 Bottle for extraction (if digestion/extraction using HCl is used)—500-600 mL wide-mouth clear glass, with fluoropolymer-lined cap.

6.4.3.2 Bottle for back-extraction—100-200 mL narrow-mouth clear glass with fluoropolymer-lined cap.

6.4.3.3 Mechanical shaker—Wrist-action or platform-type rotary shaker that produces vigorous agitation (Sybron Thermolyne Model LE “Big Bill” rotator/shaker, or equivalent).

6.4.3.4 Rack attached to shaker table to permit agitation of four to nine samples simultaneously.

6.4.4 Beakers—400-500 mL.

6.4.5 Spatulas—Stainless steel.

6.5 Filtration Apparatus.

6.5.1 Pyrex glass wool—Solvent-extracted by SDS for three hours minimum.

NOTE: Baking glass wool may cause active sites that will irreversibly adsorb CDDs/CDFs.

6.5.2 Glass funnel—125-250 mL.

6.5.3 Glass-fiber filter paper—Whatman GF/D (or equivalent), to fit glass funnel in Section 6.5.2.

6.5.4 Drying column—15-20 mm ID Pyrex chromatographic column equipped with coarse-glass frit or glass-wool plug.

6.5.5 Buchner funnel—15 cm.

6.5.6 Glass-fiber filter paper—to fit Buchner funnel in Section 6.5.5.

6.5.7 Filtration flasks—1.5-2.0 L, with side arm.

6.5.8 Pressure filtration apparatus—Millipore YT30 142 HW, or equivalent.

6.6 Centrifuge Apparatus.

6.6.1 Centrifuge—Capable of rotating 500 mL centrifuge bottles or 15 mL centrifuge tubes at 5,000 rpm minimum.

6.6.2 Centrifuge bottles—500 mL, with screw-caps, to fit centrifuge.

6.6.3 Centrifuge tubes—12-15 mL, with screw-caps, to fit centrifuge.

6.7 Cleanup Apparatus.

6.7.1 Automated gel permeation chromatograph (Analytical Biochemical Labs, Inc, Columbia, MO, Model GPC Autoprep 1002, or equivalent).

6.7.1.1 Column—600-700 mm long × 25 mm ID, packed with 70 g of SX-3 Bio-beads (Bio-Rad Laboratories, Richmond, CA, or equivalent).

6.7.1.2 Syringe—10 mL, with Luer fitting.

6.7.1.3 Syringe filter holder—stainless steel, and glass-fiber or fluoropolymer filters (Gelman 4310, or equivalent).

6.7.1.4 UV detectors—254 nm, preparative or semi-preparative flow cell (Isco, Inc., Type 6; Schmadzu, 5 mm path length; Beckman-Altex 152W, 8 μ L micro-prep flow cell, 2 mm path; Pharmacia UV-1, 3 mm flow cell; LDC Milton-Roy UV-3, monitor #1203; or equivalent).

6.7.2 Reverse-phase high-performance liquid chromatograph.

6.7.2.1 Column oven and detector—Perkin-Elmer Model LC-65T (or equivalent) operated at 0.02 AUFS at 235 nm.

6.7.2.2 Injector—Rheodyne 7120 (or equivalent) with 50 μ L sample loop.

6.7.2.3 Column—Two 6.2 mm × 250 mm Zorbax-ODS columns in series (DuPont Instruments Division, Wilmington, DE, or equivalent), operated at 50 °C with 2.0 mL/min methanol isocratic effluent.

6.7.2.4 Pump—Altex 110A (or equivalent).

6.7.3 Pipets.

6.7.3.1 Disposable, pasteur—150 mm long × 5-mm ID (Fisher Scientific 13-678-6A, or equivalent).

6.7.3.2 Disposable, serological—10 mL (6 mm ID).

6.7.4 Glass chromatographic columns.

6.7.4.1 150 mm long × 8-mm ID, (Kontes K-420155, or equivalent) with coarse-glass frit or glass-wool plug and 250 mL reservoir.

6.7.4.2 200 mm long × 15 mm ID, with coarse-glass frit or glass-wool plug and 250 mL reservoir.

6.7.4.3 300 mm long × 25 mm ID, with 300 mL reservoir and glass or fluoropolymer stopcock.

6.7.5 Stirring apparatus for batch silica cleanup of tissue extracts.

6.7.5.1 Mechanical stirrer—Corning Model 320, or equivalent.

6.7.5.2 Bottle—500-600 mL wide-mouth clear glass.

6.7.6 Oven—For baking and storage of adsorbents, capable of maintaining a constant temperature (± 5 °C) in the range of 105-250 °C.

6.8 Concentration Apparatus.

6.8.1 Rotary evaporator—Buchi/Brinkman-American Scientific No. E5045-10 or equivalent, equipped with a variable temperature water bath.

6.8.1.1 Vacuum source for rotary evaporator equipped with shutoff valve at the evaporator and vacuum gauge.

6.8.1.2 A recirculating water pump and chiller are recommended, as use of tap water for cooling the evaporator wastes large volumes of water and can lead to inconsistent performance as water temperatures and pressures vary.

6.8.1.3 Round-bottom flask—100 mL and 500 mL or larger, with ground-glass fitting compatible with the rotary evaporator.

6.8.2 Kuderna-Danish (K-D) Concentrator.

6.8.2.1 Concentrator tube—10 mL, graduated (Kontes K-570050-1025, or equivalent) with calibration verified. Ground-glass stopper (size 19/22 joint) is used to prevent evaporation of extracts.

6.8.2.2 Evaporation flask—500 mL (Kontes K-570001-0500, or equivalent), attached to concentrator tube with springs (Kontes K-662750-0012 or equivalent).

6.8.2.3 Snyder column—Three-ball macro (Kontes K-503000-0232, or equivalent).

6.8.2.4 Boiling chips.

6.8.2.4.1 Glass or silicon carbide—Approximately 10/40 mesh, extracted with methylene chloride and baked at 450 °C for one hour minimum.

6.8.2.4.2 Fluoropolymer (optional)—Extracted with methylene chloride.

6.8.2.5 Water bath—Heated, with concentric ring cover, capable of maintaining a temperature within ± 2 °C, installed in a fume hood.

6.8.3 Nitrogen blowdown apparatus—Equipped with water bath controlled in the range of 30–60 °C (N-Evap, Organomation Associates, Inc., South Berlin, MA, or equivalent), installed in a fume hood.

6.8.4 Sample vials.

6.8.4.1 Amber glass—2–5 mL with fluoropolymer-lined screw-cap.

6.8.4.2 Glass—0.3 mL, conical, with fluoropolymer-lined screw or crimp cap.

6.9 Gas Chromatograph—Shall have splitless or on-column injection port for capillary column, temperature program with isothermal hold, and shall meet all of the performance specifications in Section 10.

6.9.1 GC column for CDDs/CDFs and for isomer specificity for 2,3,7,8-TCDD—60 \pm 5 m long \times 0.32 \pm 0.02 mm ID; 0.25 μ m 5% phenyl, 94% methyl, 1% vinyl silicone bonded-phase fused-silica capillary column (J&W DB-5, or equivalent).

6.9.2 GC column for isomer specificity for 2,3,7,8-TCDF—30 \pm 5 m long \times 0.32 \pm 0.02 mm ID; 0.25 μ m bonded-phase fused-silica capillary column (J&W DB-225, or equivalent).

6.10 Mass Spectrometer—28–40 eV electron impact ionization, shall be capable of repetitively selectively monitoring 12 exact m/z's

minimum at high resolution ($\geq 10,000$) during a period of approximately one second, and shall meet all of the performance specifications in Section 10.

6.11 GC/MS Interface—The mass spectrometer (MS) shall be interfaced to the GC such that the end of the capillary column terminates within 1 cm of the ion source but does not intercept the electron or ion beams.

6.12 Data System—Capable of collecting, recording, and storing MS data.

7.0 Reagents and Standards

7.1 pH Adjustment and Back-Extraction.

7.1.1 Potassium hydroxide—Dissolve 20 g reagent grade KOH in 100 mL reagent water.

7.1.2 Sulfuric acid—Reagent grade (specific gravity 1.84).

7.1.3 Hydrochloric acid—Reagent grade, 6N.

7.1.4 Sodium chloride—Reagent grade, prepare at 5% (w/v) solution in reagent water.

7.2 Solution Drying and Evaporation.

7.2.1 Solution drying—Sodium sulfate, reagent grade, granular, anhydrous (Baker 3375, or equivalent), rinsed with methylene chloride (20 mL/g), baked at 400 °C for one hour minimum, cooled in a desiccator, and stored in a pre-cleaned glass bottle with screw-cap that prevents moisture from entering. If, after heating, the sodium sulfate develops a noticeable grayish cast (due to the presence of carbon in the crystal matrix), that batch of reagent is not suitable for use and should be discarded. Extraction with methylene chloride (as opposed to simple rinsing) and baking at a lower temperature may produce sodium sulfate that is suitable for use.

7.2.2 Tissue drying—Sodium sulfate, reagent grade, powdered, treated and stored as above.

7.2.3 Prepurified nitrogen.

7.3 Extraction.

7.3.1 Solvents—Acetone, toluene, cyclohexane, hexane, methanol, methylene chloride, and nonane; distilled in glass, pesticide quality, lot-certified to be free of interferences.

7.3.2 White quartz sand, 60/70 mesh—For Soxhlet/Dean-Stark extraction (Aldrich Chemical, Cat. No. 27-437-9, or equivalent). Bake at 450 °C for four hours minimum.

7.4 GPC Calibration Solution—Prepare a solution containing 300 mg/mL corn oil, 15 mg/mL bis(2-ethylhexyl) phthalate, 1.4 mg/mL pentachlorophenol, 0.1 mg/mL perylene, and 0.5 mg/mL sulfur.

7.5 Adsorbents for Sample Cleanup.

7.5.1 Silica gel.

7.5.1.1 Activated silica gel—100–200 mesh, Supelco 1-3651 (or equivalent), rinsed with methylene chloride, baked at 180 °C for a minimum of one hour, cooled in a desiccator, and stored in a pre-cleaned glass bottle with

screw-cap that prevents moisture from entering.

7.5.1.2 Acid silica gel (30% w/w)—Thoroughly mix 44.0 g of concentrated sulfuric acid with 100.0 g of activated silica gel in a clean container. Break up aggregates with a stirring rod until a uniform mixture is obtained. Store in a bottle with a fluoropolymer-lined screw-cap.

7.5.1.3 Basic silica gel—Thoroughly mix 30 g of 1N sodium hydroxide with 100 g of activated silica gel in a clean container. Break up aggregates with a stirring rod until a uniform mixture is obtained. Store in a bottle with a fluoropolymer-lined screw-cap.

7.5.1.4 Potassium silicate.

7.5.1.4.1 Dissolve 56 g of high purity potassium hydroxide (Aldrich, or equivalent) in 300 mL of methanol in a 750–1000 mL flat-bottom flask.

7.5.1.4.2 Add 100 g of silica gel and a stirring bar, and stir on a hot plate at 60–70 °C for one to two hours.

7.5.1.4.3 Decant the liquid and rinse the potassium silicate twice with 100 mL portions of methanol, followed by a single rinse with 100 mL of methylene chloride.

7.5.1.4.4 Spread the potassium silicate on solvent-rinsed aluminum foil and dry for two to four hours in a hood.

7.5.1.4.5 Activate overnight at 200–250 °C.

7.5.2 Alumina—Either one of two types of alumina, acid or basic, may be used in the cleanup of sample extracts, provided that the laboratory can meet the performance specifications for the recovery of labeled compounds described in Section 9.3. The same type of alumina must be used for all samples, including those used to demonstrate initial precision and recovery (Section 9.2) and ongoing precision and recovery (Section 15.5).

7.5.2.1 Acid alumina—Supelco 19996-6C (or equivalent). Activate by heating to 130 °C for a minimum of 12 hours.

7.5.2.2 Basic alumina—Supelco 19944-6C (or equivalent). Activate by heating to 600 °C for a minimum of 24 hours. Alternatively, activate by heating in a tube furnace at 650–700 °C under an air flow rate of approximately 400 cc/minute. Do not heat over 700 °C, as this can lead to reduced capacity for retaining the analytes. Store at 130 °C in a covered flask. Use within five days of baking.

7.5.3 Carbon.

7.5.3.1 Carbpak C—(Supelco 1-0258, or equivalent).

7.5.3.2 Celite 545—(Supelco 2-0199, or equivalent).

7.5.3.3 Thoroughly mix 9.0 g Carbpak C and 41.0 g Celite 545 to produce an 18% w/w mixture. Activate the mixture at 130 °C for a minimum of six hours. Store in a desiccator.

7.5.4 Anthropogenic isolation column—Pack the column in Section 6.7.4.3 from bottom to top with the following:

7.5.4.1 2 g silica gel (Section 7.5.1.1).

7.5.4.2 2 g potassium silicate (Section 7.5.1.4).

7.5.4.3 2 g granular anhydrous sodium sulfate (Section 7.2.1).

7.5.4.4 10 g acid silica gel (Section 7.5.1.2).

7.5.4.5 2 g granular anhydrous sodium sulfate.

7.5.5 Florisil column.

7.5.5.1 Florisil—60–100 mesh, Floridin Corp (or equivalent). Soxhlet extract in 500 g portions for 24 hours.

7.5.5.2 Insert a glass wool plug into the tapered end of a graduated serological pipet (Section 6.7.3.2). Pack with 1.5 g (approx 2 mL) of Florisil topped with approx 1 mL of sodium sulfate (Section 7.2.1) and a glass wool plug.

7.5.5.3 Activate in an oven at 130–150 °C for a minimum of 24 hours and cool for 30 minutes. Use within 90 minutes of cooling.

7.6 Reference Matrices—Matrices in which the CDDs/CDFs and interfering compounds are not detected by this method.

7.6.1 Reagent water—Bottled water purchased locally, or prepared by passage through activated carbon.

7.6.2 High-solids reference matrix—Playground sand or similar material. Prepared by extraction with methylene chloride and/or baking at 450 °C for a minimum of four hours.

7.6.3 Paper reference matrix—Glass-fiber filter, Gelman Type A, or equivalent. Cut paper to simulate the surface area of the paper sample being tested.

7.6.4 Tissue reference matrix—Corn or other vegetable oil. May be prepared by extraction with methylene chloride.

7.6.5 Other matrices—This method may be verified on any reference matrix by performing the tests given in Section 9.2. Ideally, the matrix should be free of the CDDs/CDFs, but in no case shall the background level of the CDDs/CDFs in the reference matrix exceed three times the minimum levels in Table 2. If low background levels of the CDDs/CDFs are present in the reference matrix, the spike level of the analytes used in Section 9.2 should be increased to provide a spike-to-background ratio in the range of 1:1 to 5:1 (Reference 15).

7.7 Standard Solutions—Purchased as solutions or mixtures with certification to their purity, concentration, and authenticity, or prepared from materials of known purity and composition. If the chemical purity is 98% or greater, the weight may be used without correction to compute the concentration of the standard. When not being used, standards are stored in the dark at room temperature in screw-capped vials with fluoropolymer-lined caps. A mark is placed on the vial at the level of the solution so that solvent loss by evaporation can be detected. If solvent loss has occurred, the solution should be replaced.

7.8 Stock Solutions.

7.8.1 Preparation—Prepare in nonane per the steps below or purchase as dilute solutions (Cambridge Isotope Laboratories (CIL), Woburn, MA, or equivalent). Observe the safety precautions in Section 5, and the recommendation in Section 5.1.2.

7.8.2 Dissolve an appropriate amount of assayed reference material in solvent. For example, weigh 1–2 mg of 2,3,7,8-TCDD to three significant figures in a 10 mL ground-glass-stoppered volumetric flask and fill to the mark with nonane. After the TCDD is completely dissolved, transfer the solution to a clean 15 mL vial with fluoropolymer-lined cap.

7.8.3 Stock standard solutions should be checked for signs of degradation prior to the preparation of calibration or performance test standards. Reference standards that can be used to determine the accuracy of calibration standards are available from CIL and may be available from other vendors.

7.9 PAR Stock Solution

7.9.1 All CDDs/CDFs—Using the solutions in Section 7.8, prepare the PAR stock solution to contain the CDDs/CDFs at the concentrations shown in Table 3. When diluted, the solution will become the PAR (Section 7.14).

7.9.2 If only 2,3,7,8-TCDD and 2,3,7,8-TCDF are to be determined, prepare the PAR stock solution to contain these compounds only.

7.10 Labeled-Compound Spiking Solution.

7.10.1 All CDDs/CDFs—From stock solutions, or from purchased mixtures, prepare this solution to contain the labeled compounds in nonane at the concentrations shown in Table 3. This solution is diluted with acetone prior to use (Section 7.10.3).

7.10.2 If only 2,3,7,8-TCDD and 2,3,7,8-TCDF are to be determined, prepare the labeled-compound solution to contain these compounds only. This solution is diluted with acetone prior to use (Section 7.10.3).

7.10.3 Dilute a sufficient volume of the labeled compound solution (Section 7.10.1 or 7.10.2) by a factor of 50 with acetone to prepare a diluted spiking solution. Each sample requires 1.0 mL of the diluted solution, but no more solution should be prepared than can be used in one day.

7.11 Cleanup Standard—Prepare $^{37}\text{Cl}^{14}$ -2,3,7,8-TCDD in nonane at the concentration shown in Table 3. The cleanup standard is added to all extracts prior to cleanup to measure the efficiency of the cleanup process.

7.12 Internal Standard(s).

7.12.1 All CDDs/CDFs—Prepare the internal standard solution to contain $^{13}\text{C}^{12}$ -1,2,3,4-TCDD and $^{13}\text{C}^{12}$ -1,2,3,7,8,9-HxCDD in nonane at the concentration shown in Table 3.

7.12.2 If only 2,3,7,8-TCDD and 2,3,7,8-TCDF are to be determined, prepare the internal standard solution to contain $^{13}\text{C}^{12}$ -1,2,3,4-TCDD only.

7.13 Calibration Standards (CS1 through CS5)—Combine the solutions in Sections 7.9 through 7.12 to produce the five calibration solutions shown in Table 4 in nonane. These solutions permit the relative response (labeled to native) and response factor to be measured as a function of concentration. The CS3 standard is used for calibration verification (VER). If only 2,3,7,8-TCDD and 2,3,7,8-TCDF are to be determined, combine the solutions appropriate to these compounds.

7.14 Precision and Recovery (PAR) Standard—Used for determination of initial (Section 9.2) and ongoing (Section 15.5) precision and recovery. Dilute 10 μL of the precision and recovery standard (Section 7.9.1 or 7.9.2) to 2.0 mL with acetone for each sample matrix for each sample batch. One mL each are required for the blank and OPR with each matrix in each batch.

7.15 GC Retention Time Window Defining Solution and Isomer Specificity Test Standard—Used to define the beginning and ending retention times for the dioxin and furan isomers and to demonstrate isomer specificity of the GC columns employed for determination of 2,3,7,8-TCDD and 2,3,7,8-TCDF. The standard must contain the compounds listed in Table 5 (CIL EDF-4006, or equivalent), at a minimum. It is not necessary to monitor the window-defining compounds if only 2,3,7,8-TCDD and 2,3,7,8-TCDF are to be determined. In this case, an isomer-specificity test standard containing the most closely eluted isomers listed in Table 5 (CIL EDF-4033, or equivalent) may be used.

7.16 QC Check Sample—A QC Check Sample should be obtained from a source independent of the calibration standards. Ideally, this check sample would be a certified reference material containing the CDDs/CDFs in known concentrations in a sample matrix similar to the matrix under test.

7.17 Stability of Solutions—Standard solutions used for quantitative purposes (Sections 7.9 through 7.15) should be analyzed periodically, and should be assayed against reference standards (Section 7.8.3) before further use.

8.0 Sample Collection, Preservation, Storage, and Holding Times

8.1 Collect samples in amber glass containers following conventional sampling practices (Reference 16). Aqueous samples that flow freely are collected in refrigerated bottles using automatic sampling equipment. Solid samples are collected as grab samples using wide-mouth jars.

8.2 Maintain aqueous samples in the dark at 0–4 °C from the time of collection until receipt at the laboratory. If residual chlorine is present in aqueous samples, add 80 mg sodium thiosulfate per liter of water. EPA

Methods 330.4 and 330.5 may be used to measure residual chlorine (Reference 17). If sample pH is greater than 9, adjust to pH 7-9 with sulfuric acid.

Maintain solid, semi-solid, oily, and mixed-phase samples in the dark at <4 °C from the time of collection until receipt at the laboratory.

Store aqueous samples in the dark at 0-4 °C. Store solid, semi-solid, oily, mixed-phase, and tissue samples in the dark at <-10 °C.

8.3 Fish and Tissue Samples.

8.3.1 Fish may be cleaned, filleted, or processed in other ways in the field, such that the laboratory may expect to receive whole fish, fish fillets, or other tissues for analysis.

8.3.2 Fish collected in the field should be wrapped in aluminum foil, and must be maintained at a temperature less than 4 °C from the time of collection until receipt at the laboratory.

8.3.3 Samples must be frozen upon receipt at the laboratory and maintained in the dark at <-10 °C until prepared. Maintain unused sample in the dark at <-10 °C.

8.4 Holding Times.

8.4.1 There are no demonstrated maximum holding times associated with CDDs/CDFs in aqueous, solid, semi-solid, tissues, or other sample matrices. If stored in the dark at 0-4 °C and preserved as given above (if required), aqueous samples may be stored for up to one year. Similarly, if stored in the dark at <-10 °C, solid, semi-solid, multi-phase, and tissue samples may be stored for up to one year.

8.4.2 Store sample extracts in the dark at <-10 °C until analyzed. If stored in the dark at <-10 °C, sample extracts may be stored for up to one year.

9.0 Quality Assurance/Quality Control

9.1 Each laboratory that uses this method is required to operate a formal quality assurance program (Reference 18). The minimum requirements of this program consist of an initial demonstration of laboratory capability, analysis of samples spiked with labeled compounds to evaluate and document data quality, and analysis of standards and blanks as tests of continued performance. Laboratory performance is compared to established performance criteria to determine if the results of analyses meet the performance characteristics of the method.

If the method is to be applied to sample matrix other than water (e.g., soils, filter cake, compost, tissue) the most appropriate alternate matrix (Sections 7.6.2 through 7.6.5) is substituted for the reagent water matrix (Section 7.6.1) in all performance tests.

9.1.1 The analyst shall make an initial demonstration of the ability to generate acceptable accuracy and precision with this

method. This ability is established as described in Section 9.2.

9.1.2 In recognition of advances that are occurring in analytical technology, and to allow the analyst to overcome sample matrix interferences, the analyst is permitted certain options to improve separations or lower the costs of measurements. These options include alternate extraction, concentration, cleanup procedures, and changes in columns and detectors. Alternate determinative techniques, such as the substitution of spectroscopic or immuno-assay techniques, and changes that degrade method performance, are not allowed. If an analytical technique other than the techniques specified in this method is used, that technique must have a specificity equal to or better than the specificity of the techniques in this method for the analytes of interest.

9.1.2.1 Each time a modification is made to this method, the analyst is required to repeat the procedure in Section 9.2. If the detection limit of the method will be affected by the change, the laboratory is required to demonstrate that the MDL (40 CFR Part 136, Appendix B) is lower than one-third the regulatory compliance level or one-third the ML in this method, whichever is higher. If calibration will be affected by the change, the analyst must recalibrate the instrument per Section 10.

9.1.2.2 The laboratory is required to maintain records of modifications made to this method. These records include the following, at a minimum:

9.1.2.2.1 The names, titles, addresses, and telephone numbers of the analyst(s) who performed the analyses and modification, and of the quality control officer who witnessed and will verify the analyses and modifications.

9.1.2.2.2 A listing of pollutant(s) measured, by name and CAS Registry number.

9.1.2.2.3 A narrative stating reason(s) for the modifications.

9.1.2.2.4 Results from all quality control (QC) tests comparing the modified method to this method, including:

(a) Calibration (Section 10.5 through 10.7).
(b) Calibration verification (Section 15.3).
(c) Initial precision and recovery (Section 9.2).

(d) Labeled compound recovery (Section 9.3).

(e) Analysis of blanks (Section 9.5).
(f) Accuracy assessment (Section 9.4).

9.1.2.2.5 Data that will allow an independent reviewer to validate each determination by tracing the instrument output (peak height, area, or other signal) to the final result. These data are to include:

(a) Sample numbers and other identifiers.
(b) Extraction dates.
(c) Analysis dates and times.
(d) Analysis sequence/run chronology.
(e) Sample weight or volume (Section 11).

(f) Extract volume prior to each cleanup step (Section 13).

(g) Extract volume after each cleanup step (Section 13).

(h) Final extract volume prior to injection (Section 14).

(i) Injection volume (Section 14.3).

(j) Dilution data, differentiating between dilution of a sample or extract (Section 17.5).

(k) Instrument and operating conditions.

(l) Column (dimensions, liquid phase, solid support, film thickness, etc).

(m) Operating conditions (temperatures, temperature program, flow rates).

(n) Detector (type, operating conditions, etc).

(o) Chromatograms, printer tapes, and other recordings of raw data.

(p) Quantitation reports, data system outputs, and other data to link the raw data to the results reported.

9.1.3 Analyses of method blanks are required to demonstrate freedom from contamination (Section 4.3). The procedures and criteria for analysis of a method blank are described in Sections 9.5 and 15.6.

9.1.4 The laboratory shall spike all samples with labeled compounds to monitor method performance. This test is described in Section 9.3. When results of these spikes indicate atypical method performance for samples, the samples are diluted to bring method performance within acceptable limits. Procedures for dilution are given in Section 17.5.

9.1.5 The laboratory shall, on an ongoing basis, demonstrate through calibration verification and the analysis of the ongoing precision and recovery aliquot that the analytical system is in control. These procedures are described in Sections 15.1 through 15.5.

9.1.6 The laboratory shall maintain records to define the quality of data that is generated. Development of accuracy statements is described in Section 9.4.

9.2 Initial Precision and Recovery (IPR)—To establish the ability to generate acceptable precision and recovery, the analyst shall perform the following operations.

9.2.1 For low solids (aqueous) samples, extract, concentrate, and analyze four 1 L aliquots of reagent water spiked with the diluted labeled compound spiking solution (Section 7.10.3) and the precision and recovery standard (Section 7.14) according to the procedures in Sections 11 through 18. For an alternative sample matrix, four aliquots of the alternative reference matrix (Section 7.6) are used. All sample processing steps that are to be used for processing samples, including preparation (Section 11), extraction (Section 12), and cleanup (Section 13), shall be included in this test.

9.2.2 Using results of the set of four analyses, compute the average concentration (X) of the extracts in ng/mL and the standard de-

viation of the concentration (s) in ng/mL for each compound, by isotope dilution for CDDs/CDFs with a labeled analog, and by internal standard for 1,2,3,7,8,9-HxCDD, OCDF, and the labeled compounds.

9.2.3 For each CDD/CDF and labeled compound, compare s and X with the corresponding limits for initial precision and recovery in Table 6. If only 2,3,7,8-TCDD and 2,3,7,8-TCDF are to be determined, compare s and X with the corresponding limits for initial precision and recovery in Table 6a. If s and X for all compounds meet the acceptance criteria, system performance is acceptable and analysis of blanks and samples may begin. If, however, any individual s exceeds the precision limit or any individual X falls outside the range for accuracy, system performance is unacceptable for that compound. Correct the problem and repeat the test (Section 9.2).

9.3 The laboratory shall spike all samples with the diluted labeled compound spiking solution (Section 7.10.3) to assess method performance on the sample matrix.

9.3.1 Analyze each sample according to the procedures in Sections 11 through 18.

9.3.2 Compute the percent recovery of the labeled compounds and the cleanup standard using the internal standard method (Section 17.2).

9.3.3 The recovery of each labeled compound must be within the limits in Table 7 when all 2,3,7,8-substituted CDDs/CDFs are determined, and within the limits in Table 7a when only 2,3,7,8-TCDD and 2,3,7,8-TCDF are determined. If the recovery of any compound falls outside of these limits, method performance is unacceptable for that compound in that sample. To overcome such difficulties, water samples are diluted and smaller amounts of soils, sludges, sediments, and other matrices are reanalyzed per Section 18.4.

9.4 Recovery of labeled compounds from samples should be assessed and records should be maintained.

9.4.1 After the analysis of five samples of a given matrix type (water, soil, sludge, pulp, etc.) for which the labeled compounds pass the tests in Section 9.3, compute the average percent recovery (R) and the standard deviation of the percent recovery (SR) for the labeled compounds only. Express the assessment as a percent recovery interval from $R - 2S_R$ to $R + 2S_R$ for each matrix. For example, if $R = 90\%$ and $S_R = 10\%$ for five analyses of pulp, the recovery interval is expressed as 70-110%.

9.4.2 Update the accuracy assessment for each labeled compound in each matrix on a regular basis (e.g., after each 5-10 new measurements).

9.5 Method Blanks—Reference matrix method blanks are analyzed to demonstrate freedom from contamination (Section 4.3).

9.5.1 Prepare, extract, clean up, and concentrate a method blank with each sample batch (samples of the same matrix started through the extraction process on the same 12-hour shift, to a maximum of 20 samples). The matrix for the method blank shall be similar to sample matrix for the batch, e.g., a 1 L reagent water blank (Section 7.6.1), high-solids reference matrix blank (Section 7.6.2), paper matrix blank (Section 7.6.3); tissue blank (Section 7.6.4) or alternative reference matrix blank (Section 7.6.5). Analyze the blank immediately after analysis of the OPR (Section 15.5) to demonstrate freedom from contamination.

9.5.2 If any 2,3,7,8-substituted CDD/CDF (Table 1) is found in the blank at greater than the minimum level (Table 2) or one-third the regulatory compliance level, whichever is greater; or if any potentially interfering compound is found in the blank at the minimum level for each level of chlorination given in Table 2 (assuming a response factor of 1 relative to the $^{13}\text{C}_{12}$ -1,2,3,4-TCDD internal standard for compounds not listed in Table 1), analysis of samples is halted until the blank associated with the sample batch shows no evidence of contamination at this level. All samples must be associated with an uncontaminated method blank before the results for those samples may be reported for regulatory compliance purposes.

9.6 QC Check Sample—Analyze the QC Check Sample (Section 7.16) periodically to assure the accuracy of calibration standards and the overall reliability of the analytical process. It is suggested that the QC Check Sample be analyzed at least quarterly.

9.7 The specifications contained in this method can be met if the apparatus used is calibrated properly and then maintained in a calibrated state. The standards used for calibration (Section 10), calibration verification (Section 15.3), and for initial (Section 9.2) and ongoing (Section 15.5) precision and recovery should be identical, so that the most precise results will be obtained. A GC/MS instrument will provide the most reproducible results if dedicated to the settings and conditions required for the analyses of CDDs/CDFs by this method.

9.8 Depending on specific program requirements, field replicates may be collected to determine the precision of the sampling technique, and spiked samples may be required to determine the accuracy of the analysis when the internal standard method is used.

10.0 Calibration

10.1 Establish the operating conditions necessary to meet the minimum retention times for the internal standards in Section 10.2.4 and the relative retention times for the CDDs/CDFs in Table 2.

10.1.1 Suggested GC operating conditions:

Injector temperature: 270 °C
Interface temperature: 290 °C
Initial temperature: 200 °C
Initial time: Two minutes
Temperature program:
200–220 °C, at 5 °C/minute
220 °C for 16 minutes
220–235 °C, at 5 °C/minute
235 °C for seven minutes
235–330 °C, at 5 °C/minute

NOTE: All portions of the column that connect the GC to the ion source shall remain at or above the interface temperature specified above during analysis to preclude condensation of less volatile compounds.

Optimize GC conditions for compound separation and sensitivity. Once optimized, the same GC conditions must be used for the analysis of all standards, blanks, IPR and OPR aliquots, and samples.

10.1.2 Mass spectrometer (MS) resolution—Obtain a selected ion current profile (SICP) of each analyte in Table 3 at the two exact m/z 's specified in Table 8 and at $\geq 10,000$ resolving power by injecting an authentic standard of the CDDs/CDFs either singly or as part of a mixture in which there is no interference between closely eluted components.

10.1.2.1 The analysis time for CDDs/CDFs may exceed the long-term mass stability of the mass spectrometer. Because the instrument is operated in the high-resolution mode, mass drifts of a few ppm (e.g., 5 ppm in mass) can have serious adverse effects on instrument performance. Therefore, a mass-drift correction is mandatory and a lock-mass m/z from PFK is used for drift correction. The lock-mass m/z is dependent on the exact m/z 's monitored within each descriptor, as shown in Table 8. The level of PFK metered into the HRMS during analyses should be adjusted so that the amplitude of the most intense selected lock-mass m/z signal (regardless of the descriptor number) does not exceed 10% of the full-scale deflection for a given set of detector parameters. Under those conditions, sensitivity changes that might occur during the analysis can be more effectively monitored.

NOTE: Excessive PFK (or any other reference substance) may cause noise problems and contamination of the ion source necessitating increased frequency of source cleaning.

10.1.2.2 If the HRMS has the capability to monitor resolution during the analysis, it is acceptable to terminate the analysis when the resolution falls below 10,000 to save reanalysis time.

10.1.2.3 Using a PFK molecular leak, tune the instrument to meet the minimum required resolving power of 10,000 (10% valley) at m/z 304.9824 (PFK) or any other reference signal close to m/z 304 (from TCDF). For each

descriptor (Table 8), monitor and record the resolution and exact m/z 's of three to five reference peaks covering the mass range of the descriptor. The resolution must be greater than or equal to 10,000, and the deviation between the exact m/z and the theoretical m/z (Table 8) for each exact m/z monitored must be less than 5 ppm.

10.2 Ion Abundance Ratios, Minimum Levels, Signal-to-Noise Ratios, and Absolute Retention Times—Choose an injection volume of either 1 μL or 2 μL , consistent with the capability of the HRGC/HRMS instrument. Inject a 1 μL or 2 μL aliquot of the CS1 calibration solution (Table 4) using the GC conditions from Section 10.1.1. If only 2,3,7,8-TCDD and 2,3,7,8-TCDF are to be determined, the operating conditions and specifications below apply to analysis of those compounds only.

10.2.1 Measure the SICP areas for each analyte, and compute the ion abundance ratios at the exact m/z 's specified in Table 8. Compare the computed ratio to the theoretical ratio given in Table 9.

10.2.1.1 The exact m/z 's to be monitored in each descriptor are shown in Table 8. Each group or descriptor shall be monitored in succession as a function of GC retention time to ensure that all CDDs/CDFs are detected. Additional m/z 's may be monitored in each descriptor, and the m/z 's may be divided among more than the five descriptors listed in Table 8, provided that the laboratory is able to monitor the m/z 's of all the CDDs/CDFs that may elute from the GC in a given retention-time window. If only 2,3,7,8-TCDD and 2,3,7,8-TCDF are to be determined, the descriptors may be modified to include only the exact m/z 's for the tetra- and penta-isomers, the diphenyl ethers, and the lock m/z 's.

10.2.1.2 The mass spectrometer shall be operated in a mass-drift correction mode, using perfluorokerosene (PFK) to provide lock m/z 's. The lock-mass for each group of m/z 's is shown in Table 8. Each lock mass shall be monitored and shall not vary by more than $\pm 20\%$ throughout its respective retention time window. Variations of the lock mass by more than 20% indicate the presence of coeluting interferences that may significantly reduce the sensitivity of the mass spectrometer. Reinjection of another aliquot of the sample extract will not resolve the problem. Additional cleanup of the extract may be required to remove the interferences.

10.2.2 All CDDs/CDFs and labeled compounds in the CS1 standard shall be within the QC limits in Table 9 for their respective ion abundance ratios; otherwise, the mass spectrometer shall be adjusted and this test repeated until the m/z ratios fall within the limits specified. If the adjustment alters the resolution of the mass spectrometer, resolution shall be verified (Section 10.1.2) prior to repeat of the test.

10.2.3 Verify that the HRGC/HRMS instrument meets the minimum levels in Table 2. The peaks representing the CDDs/CDFs and labeled compounds in the CS1 calibration standard must have signal-to-noise ratios (S/N) greater than or equal to 10.0. Otherwise, the mass spectrometer shall be adjusted and this test repeated until the minimum levels in Table 2 are met.

10.2.4 The absolute retention time of $^{13}\text{C}_{12}$ -1,2,3,4-TCDD (Section 7.12) shall exceed 25.0 minutes on the DB-5 column, and the retention time of $^{13}\text{C}_{12}$ -1,2,3,4-TCDD shall exceed 15.0 minutes on the DB-225 column; otherwise, the GC temperature program shall be adjusted and this test repeated until the above-stated minimum retention time criteria are met.

2010.3 Retention-Time Windows—Analyze the window defining mixtures (Section 7.15) using the optimized temperature program in Section 10.1. Table 5 gives the elution order (first/last) of the window-defining compounds. If 2,3,7,8-TCDD and 2,3,7,8-TCDF only are to be analyzed, this test is not required.

10.4 Isomer Specificity.

10.4.1 Analyze the isomer specificity test standards (Section 7.15) using the procedure in Section 14 and the optimized conditions for sample analysis (Section 10.1.1).

10.4.2 Compute the percent valley between the GC peaks that elute most closely to the 2,3,7,8-TCDD and TCDF isomers, on their respective columns, per Figures 6 and 7.

10.4.3 Verify that the height of the valley between the most closely eluted isomers and the 2,3,7,8-substituted isomers is less than 25% (computed as $100 \times y$ in Figures 6 and 7). If the valley exceeds 25%, adjust the analytical conditions and repeat the test or replace the GC column and recalibrate (Sections 10.1.2 through 10.7).

10.5 Calibration by Isotope Dilution—Isotope dilution calibration is used for the 15 2,3,7,8-substituted CDDs/CDFs for which labeled compounds are added to samples prior to extraction. The reference compound for each CDD/CDF compound is shown in Table 2.

10.5.1 A calibration curve encompassing the concentration range is prepared for each compound to be determined. The relative response (RR) (labeled to native) vs. concentration in standard solutions is plotted or computed using a linear regression. Relative response is determined according to the procedures described below. Five calibration points are employed.

10.5.2 The response of each CDD/CDF relative to its labeled analog is determined using the area responses of both the primary and secondary exact m/z 's specified in Table 8, for each calibration standard, as follows:

$$RR = \frac{(A1_n + A2_n) C_1}{(A1_1 + A2_1) C_n}$$

where:

A1_n and A2_n = The areas of the primary and secondary m/z's for the CDD/CDF.

A1₁ and A2₁ = The areas of the primary and secondary m/z's for the labeled compound.

C₁ = The concentration of the labeled compound in the calibration standard (Table 4).

C_n = The concentration of the native compound in the calibration standard (Table 4).

10.5.3 To calibrate the analytical system by isotope dilution, inject a volume of calibration standards CS1 through CS5 (Section 7.13 and Table 4) identical to the volume chosen in Section 10.2, using the procedure in Section 14 and the conditions in Section 10.1.1 and Table 2. Compute the relative response (RR) at each concentration.

10.5.4 Linearity—If the relative response for any compound is constant (less than 20% coefficient of variation) over the five-point calibration range, an averaged relative response may be used for that compound; otherwise, the complete calibration curve for that compound shall be used over the five-point calibration range.

10.6 Calibration by Internal Standard—The internal standard method is applied to determination of 1,2,3,7,8,9-HxCDD (Section 17.1.2), OCDF (Section 17.1.1), the non 2,3,7,8-substituted compounds, and to the determination of labeled compounds for intralaboratory statistics (Sections 9.4 and 15.5.4).

10.6.1 Response factors—Calibration requires the determination of response factors (RF) defined by the following equation:

$$RF = \frac{(A1_s + A2_s) C_{is}}{(A1_{is} + A2_{is}) C_s}$$

where:

A1_s and A2_s = The areas of the primary and secondary m/z's for the CDD/CDF.

A1_{is} and A2_{is} = The areas of the primary and secondary m/z's for the internal standard.

C_{is} = The concentration of the internal standard (Table 4).

C_s = The concentration of the compound in the calibration standard (Table 4).

NOTE: There is only one m/z for ³⁷Cl₄-2,3,7,8-TCDD. See Table 8.

10.6.2 To calibrate the analytical system by internal standard, inject 1.0 μL or 2.0 μL of calibration standards CS1 through CS5 (Section 7.13 and Table 4) using the procedure in Section 14 and the conditions in Sec-

tion 10.1.1 and Table 2. Compute the response factor (RF) at each concentration.

10.6.3 Linearity—If the response factor (RF) for any compound is constant (less than 35% coefficient of variation) over the five-point calibration range, an averaged response factor may be used for that compound; otherwise, the complete calibration curve for that compound shall be used over the five-point range.

10.7 Combined Calibration—By using calibration solutions (Section 7.13 and Table 4) containing the CDDs/CDFs and labeled compounds and the internal standards, a single set of analyses can be used to produce calibration curves for the isotope dilution and internal standard methods. These curves are verified each shift (Section 15.3) by analyzing the calibration verification standard (VER, Table 4). Recalibration is required if any of the calibration verification criteria (Section 15.3) cannot be met.

10.8 Data Storage—MS data shall be collected, recorded, and stored.

10.8.1 Data acquisition—The signal at each exact m/z shall be collected repetitively throughout the monitoring period and stored on a mass storage device.

10.8.2 Response factors and multipoint calibrations—The data system shall be used to record and maintain lists of response factors (response ratios for isotope dilution) and multipoint calibration curves. Computations of relative standard deviation (coefficient of variation) shall be used to test calibration linearity. Statistics on initial performance (Section 9.2) and ongoing performance (Section 15.5) should be computed and maintained, either on the instrument data system, or on a separate computer system.

11.0 Sample Preparation

11.1 Sample preparation involves modifying the physical form of the sample so that the CDDs/CDFs can be extracted efficiently. In general, the samples must be in a liquid form or in the form of finely divided solids in order for efficient extraction to take place. Table 10 lists the phases and suggested quantities for extraction of various sample matrices.

For samples known or expected to contain high levels of the CDDs/CDFs, the smallest sample size representative of the entire sample should be used (see Section 17.5).

For all samples, the blank and IPR/OPR aliquots must be processed through the same steps as the sample to check for contamination and losses in the preparation processes.

11.1.1 For samples that contain particles, percent solids and particle size are determined using the procedures in Sections 11.2 and 11.3, respectively.

11.1.2 Aqueous samples—Because CDDs/CDFs may be bound to suspended particles, the preparation of aqueous samples is dependent on the solids content of the sample.

11.1.2.1 Aqueous samples visibly absent particles are prepared per Section 11.4 and extracted directly using the separatory funnel or SPE techniques in Sections 12.1 or 12.2, respectively.

11.1.2.2 Aqueous samples containing visible particles and containing one percent suspended solids or less are prepared using the procedure in Section 11.4. After preparation, the sample is extracted directly using the SPE technique in 12.2 or filtered per Section 11.4.3. After filtration, the particles and filter are extracted using the SDS procedure in Section 12.3 and the filtrate is extracted using the separatory funnel procedure in Section 12.1.

11.1.2.3 For aqueous samples containing greater than one percent solids, a sample aliquot sufficient to provide 10 g of dry solids is used, as described in Section 11.5.

11.1.3 Solid samples are prepared using the procedure described in Section 11.5 followed by extraction via the SDS procedure in Section 12.3.

11.1.4 Multiphase samples—The phase(s) containing the CDDs/CDFs is separated from the non-CDD/CDF phase using pressure fil-

tration and centrifugation, as described in Section 11.6. The CDDs/CDFs will be in the organic phase in a multiphase sample in which an organic phase exists.

11.1.5 Procedures for grinding, homogenization, and blending of various sample phases are given in Section 11.7.

11.1.6 Tissue samples—Preparation procedures for fish and other tissues are given in Section 11.8.

11.2 Determination of Percent Suspended Solids.

NOTE: This aliquot is used for determining the solids content of the sample, not for determination of CDDs/CDFs.

11.2.1 Aqueous liquids and multi-phase samples consisting of mainly an aqueous phase.

11.2.1.1 Dessicate and weigh a GF/D filter (Section 6.5.3) to three significant figures.

11.2.1.2 Filter 10.0 ±0.02 mL of well-mixed sample through the filter.

11.2.1.3 Dry the filter a minimum of 12 hours at 110 ±5 °C and cool in a dessicator.

11.2.1.4 Calculate percent solids as follows:

$$\% \text{ solids} = \frac{\text{weight of sample aliquot after drying (g)} - \text{weight of filter (g)}}{10 \text{ g}} \times 100$$

11.2.2 Non-aqueous liquids, solids, semi-solid samples, and multi-phase samples in which the main phase is not aqueous; but not tissues.

11.2.2.1 Weigh 5–10 g of sample to three significant figures in a tared beaker.

11.2.2.2 Dry a minimum of 12 hours at 110 ±5 °C, and cool in a dessicator.

11.2.2.3 Calculate percent solids as follows:

$$\% \text{ solids} = \frac{\text{weight of sample aliquot after drying}}{\text{weight of sample aliquot before drying}} \times 100$$

11.3 Determination of Particle Size.

11.3.1 Spread the dried sample from Section 11.2.2.2 on a piece of filter paper or aluminum foil in a fume hood or glove box.

11.3.2 Estimate the size of the particles in the sample. If the size of the largest particles is greater than 1 mm, the particle size must be reduced to 1 mm or less prior to extraction using the procedures in Section 11.7.

11.4 Preparation of Aqueous Samples Containing 1% Suspended Solids or Less.

11.4.1 Aqueous samples visibly absent particles are prepared per the procedure below and extracted directly using the separatory funnel or SPE techniques in Sections 12.1 or 12.2, respectively. Aqueous samples con-

taining visible particles and one percent suspended solids or less are prepared using the procedure below and extracted using either the SPE technique in Section 12.2 or further prepared using the filtration procedure in Section 11.4.3. The filtration procedure is followed by SDS extraction of the filter and particles (Section 12.3) and separatory funnel extraction of the filtrate (Section 12.1). The SPE procedure is followed by SDS extraction of the filter and disk.

11.4.2 Preparation of sample and QC aliquots.

11.4.2.1 Mark the original level of the sample on the sample bottle for reference. Weigh the sample plus bottle to ±1.

11.4.2.2 Spike 1.0 mL of the diluted labeled-compound spiking solution (Section 7.10.3) into the sample bottle. Cap the bottle and mix the sample by careful shaking. Allow the sample to equilibrate for one to two hours, with occasional shaking.

11.4.2.3 For each sample or sample batch (to a maximum of 20 samples) to be extracted during the same 12-hour shift, place two 1.0 L aliquots of reagent water in clean sample bottles or flasks.

11.4.2.4 Spike 1.0 mL of the diluted labeled-compound spiking solution (Section 7.10.3) into both reagent water aliquots. One of these aliquots will serve as the method blank.

11.4.2.5 Spike 1.0 mL of the PAR standard (Section 7.14) into the remaining reagent water aliquot. This aliquot will serve as the OPR (Section 15.5).

11.4.2.6 If SPE is to be used, add 5 mL of methanol to the sample, cap and shake the sample to mix thoroughly, and proceed to Section 12.2 for extraction. If SPE is not to be used, and the sample is visibly absent particles, proceed to Section 12.1 for extraction. If SPE is not to be used and the sample contains visible particles, proceed to the following section for filtration of particles.

11.4.3 Filtration of particles.

11.4.3.1 Assemble a Buchner funnel (Section 6.5.5) on top of a clean filtration flask. Apply vacuum to the flask, and pour the entire contents of the sample bottle through a glass-fiber filter (Section 6.5.6) in the Buchner funnel, swirling the sample remaining in the bottle to suspend any particles.

11.4.3.2 Rinse the sample bottle twice with approximately 5 mL portions of reagent water to transfer any remaining particles onto the filter.

11.4.3.3 Rinse any particles off the sides of the Buchner funnel with small quantities of reagent water.

11.4.3.4 Weigh the empty sample bottle to ± 1 g. Determine the weight of the sample by difference. Save the bottle for further use.

11.4.3.5 Extract the filtrate using the separatory funnel procedure in Section 12.1.

11.4.3.6 Extract the filter containing the particles using the SDS procedure in Section 12.3.

11.5 Preparation of Samples Containing Greater Than 1% Solids.

11.5.1 Weigh a well-mixed aliquot of each sample (of the same matrix type) sufficient to provide 10 g of dry solids (based on the solids determination in Section 11.2) into a clean beaker or glass jar.

11.5.2 Spike 1.0 mL of the diluted labeled compound spiking solution (Section 7.10.3) into the sample.

11.5.3 For each sample or sample batch (to a maximum of 20 samples) to be extracted during the same 12-hour shift, weigh two 10 g aliquots of the appropriate reference matrix (Section 7.6) into clean beakers or glass jars.

11.5.4 Spike 1.0 mL of the diluted labeled compound spiking solution (Section 7.10.3) into each reference matrix aliquot. One aliquot will serve as the method blank. Spike 1.0 mL of the PAR standard (Section 7.14) into the other reference matrix aliquot. This aliquot will serve as the OPR (Section 15.5).

11.5.5 Stir or tumble and equilibrate the aliquots for one to two hours.

11.5.6 Decant excess water. If necessary to remove water, filter the sample through a glass-fiber filter and discard the aqueous liquid.

11.5.7 If particles >1 mm are present in the sample (as determined in Section 11.3.2), spread the sample on clean aluminum foil in a hood. After the sample is dry, grind to reduce the particle size (Section 11.7).

11.5.8 Extract the sample and QC aliquots using the SDS procedure in Section 12.3.

11.6 Multiphase Samples.

11.6.1 Using the percent solids determined in Section 11.2.1 or 11.2.2, determine the volume of sample that will provide 10 g of solids, up to 1 L of sample.

11.6.2 Pressure filter the amount of sample determined in Section 11.6.1 through Whatman GF/D glass-fiber filter paper (Section 6.5.3). Pressure filter the blank and OPR aliquots through GF/D papers also. If necessary to separate the phases and/or settle the solids, centrifuge these aliquots prior to filtration.

11.6.3 Discard any aqueous phase (if present). Remove any non-aqueous liquid present and reserve the maximum amount filtered from the sample (Section 11.6.1) or 10 g, whichever is less, for combination with the solid phase (Section 12.3.5).

11.6.4 If particles >1 mm are present in the sample (as determined in Section 11.3.2) and the sample is capable of being dried, spread the sample and QC aliquots on clean aluminum foil in a hood. After the aliquots are dry or if the sample cannot be dried, reduce the particle size using the procedures in Section 11.7 and extract the reduced particles using the SDS procedure in Section 12.3. If particles >1 mm are not present, extract the particles and filter in the sample and QC aliquots directly using the SDS procedure in Section 12.3.

11.7 Sample grinding, homogenization, or blending—Samples with particle sizes greater than 1 mm (as determined in Section 11.3.2) are subjected to grinding, homogenization, or blending. The method of reducing particle size to less than 1 mm is matrix-dependent. In general, hard particles can be reduced by grinding with a mortar and pestle. Softer particles can be reduced by grinding in a Wiley mill or meat grinder, by homogenization, or in a blender.

11.7.1 Each size-reducing preparation procedure on each matrix shall be verified by running the tests in Section 9.2 before the procedure is employed routinely.

11.7.2 The grinding, homogenization, or blending procedures shall be carried out in a glove box or fume hood to prevent particles from contaminating the work environment.

11.7.3 Grinding—Certain papers and pulps, slurries, and amorphous solids can be ground in a Wiley mill or heavy duty meat grinder. In some cases, reducing the temperature of the sample to freezing or to dry ice or liquid nitrogen temperatures can aid in the grinding process. Grind the sample aliquots from Section 11.5.7 or 11.6.4 in a clean grinder. Do not allow the sample temperature to exceed 50 °C. Grind the blank and reference matrix aliquots using a clean grinder.

11.7.4 Homogenization or blending—Particles that are not ground effectively, or particles greater than 1 mm in size after grinding, can often be reduced in size by high speed homogenization or blending. Homogenize and/or blend the particles or filter from Section 11.5.7 or 11.6.4 for the sample, blank, and OPR aliquots.

11.7.5 Extract the aliquots using the SDS procedure in Section 12.3.

11.8 Fish and Other Tissues—Prior to processing tissue samples, the laboratory must determine the exact tissue to be analyzed. Common requests for analysis of fish tissue include whole fish—skin on, whole fish—skin removed, edible fish fillets (filleted in the field or by the laboratory), specific organs, and other portions. Once the appropriate tissue has been determined, the sample must be homogenized.

11.8.1 Homogenization.

11.8.1.1 Samples are homogenized while still frozen, where practical. If the laboratory must dissect the whole fish to obtain the appropriate tissue for analysis, the unused tissues may be rapidly refrozen and stored in a clean glass jar for subsequent use.

11.8.1.2 Each analysis requires 10 g of tissue (wet weight). Therefore, the laboratory should homogenize at least 20 g of tissue to allow for re-extraction of a second aliquot of the same homogenized sample, if re-analysis is required. When whole fish analysis is necessary, the entire fish is homogenized.

11.8.1.3 Homogenize the sample in a tissue homogenizer (Section 6.3.3) or grind in a meat grinder (Section 6.3.4). Cut tissue too large to feed into the grinder into smaller pieces. To assure homogeneity, grind three times.

11.8.1.4 Transfer approximately 10 g (wet weight) of homogenized tissue to a clean, tared, 400-500 mL beaker. For the alternate HCl digestion/extraction, transfer the tissue to a clean, tared 500-600 mL wide-mouth bottle. Record the weight to the nearest 10 mg.

11.8.1.5 Transfer the remaining homogenized tissue to a clean jar with a fluoropolymer-lined lid. Seal the jar and store the tissue at <-10 °C. Return any tissue that was not homogenized to its original container and store at <-10 °C.

11.8.2 QC aliquots.

11.8.2.1 Prepare a method blank by adding approximately 10 g of the oily liquid reference matrix (Section 7.6.4) to a 400-500 mL beaker. For the alternate HCl digestion/extraction, add the reference matrix to a 500-600 mL wide-mouth bottle. Record the weight to the nearest 10 mg.

11.8.2.2 Prepare a precision and recovery aliquot by adding approximately 10 g of the oily liquid reference matrix (Section 7.6.4) to a separate 400-500 mL beaker or wide-mouth bottle, depending on the extraction procedure to be used. Record the weight to the nearest 10 mg. If the initial precision and recovery test is to be performed, use four aliquots; if the ongoing precision and recovery test is to be performed, use a single aliquot.

11.8.3 Spiking

11.8.3.1 Spike 1.0 mL of the labeled compound spiking solution (Section 7.10.3) into the sample, blank, and OPR aliquot.

11.8.3.2 Spike 1.0 mL of the PAR standard (Section 7.14) into the OPR aliquot.

11.8.4 Extract the aliquots using the procedures in Section 12.4.

12.0 Extraction and Concentration

Extraction procedures include separatory funnel (Section 12.1) and solid phase (Section 12.2) for aqueous liquids; Soxhlet/Dean-Stark (Section 12.3) for solids, filters, and SPE disks; and Soxhlet extraction (Section 12.4.1) and HCl digestion (Section 12.4.2) for tissues. Acid/base back-extraction (Section 12.5) is used for initial cleanup of extracts.

Macro-concentration procedures include rotary evaporation (Section 12.6.1), heating mantle (Section 12.6.2), and Kuderna-Danish (K-D) evaporation (Section 12.6.3). Micro-concentration uses nitrogen blowdown (Section 12.7).

12.1 Separatory funnel extraction of filtrates and of aqueous samples visibly absent particles.

12.1.1 Pour the spiked sample (Section 11.4.2.2) or filtrate (Section 11.4.3.5) into a 2 L separatory funnel. Rinse the bottle or flask twice with 5 mL of reagent water and add these rinses to the separatory funnel.

12.1.2 Add 60 mL methylene chloride to the empty sample bottle (Section 12.1.1), seal, and shake 60 seconds to rinse the inner surface. Transfer the solvent to the separatory funnel, and extract the sample by shaking the funnel for two minutes with periodic venting. Allow the organic layer to separate from the aqueous phase for a minimum of 10 minutes. If an emulsion forms and is more than one-third the volume of the solvent layer, employ mechanical techniques to complete the phase separation (see note below). Drain the methylene chloride extract

through a solvent-rinsed glass funnel approximately one-half full of granular anhydrous sodium sulfate (Section 7.2.1) supported on clean glass-fiber paper into a solvent-rinsed concentration device (Section 12.6).

NOTE: If an emulsion forms, the analyst must employ mechanical techniques to complete the phase separation. The optimum technique depends upon the sample, but may include stirring, filtration through glass wool, use of phase separation paper, centrifugation, use of an ultrasonic bath with ice, addition of NaCl, or other physical methods. Alternatively, solid-phase or other extraction techniques may be used to prevent emulsion formation. Any alternative technique is acceptable so long as the requirements in Section 9 are met.

Experience with aqueous samples high in dissolved organic materials (e.g., paper mill effluents) has shown that acidification of the sample prior to extraction may reduce the formation of emulsions. Paper industry methods suggest that the addition of up to 400 mL of ethanol to a 1 L effluent sample may also reduce emulsion formation. However, studies by EPA suggest that the effect may be a result of sample dilution, and that the addition of reagent water may serve the same function. Mechanical techniques may still be necessary to complete the phase separation. If either acidification or addition of ethanol is utilized, the laboratory must perform the startup tests described in Section 9.2 using the same techniques.

12.1.3 Extract the water sample two more times with 60 mL portions of methylene chloride. Drain each portion through the sodium sulfate into the concentrator. After the third extraction, rinse the separatory funnel with at least 20 mL of methylene chloride, and drain this rinse through the sodium sulfate into the concentrator. Repeat this rinse at least twice. Set aside the funnel with sodium sulfate if the extract is to be combined with the extract from the particles.

12.1.4 Concentrate the extract using one of the macro-concentration procedures in Section 12.6.

12.1.4.1 If the extract is from a sample visibly absent particles (Section 11.1.2.1), adjust the final volume of the concentrated extract to approximately 10 mL with hexane, transfer to a 250 mL separatory funnel, and back-extract using the procedure in Section 12.5.

12.1.4.2 If the extract is from the aqueous filtrate (Section 11.4.3.5), set aside the concentration apparatus for addition of the SDS extract from the particles (Section 12.3.9.1.2).

12.2 SPE of Samples Containing Less Than 1% Solids (References 19-20).

12.2.1 Disk preparation.

12.2.1.1 Place an SPE disk on the base of the filter holder (Figure 4) and wet with tol-

uene. While holding a GMF 150 filter above the SPE disk with tweezers, wet the filter with toluene and lay the filter on the SPE disk, making sure that air is not trapped between the filter and disk. Clamp the filter and SPE disk between the 1 L glass reservoir and the vacuum filtration flask.

12.2.1.2 Rinse the sides of the filtration flask with approx 15 mL of toluene using a squeeze bottle or syringe. Apply vacuum momentarily until a few drops appear at the drip tip. Release the vacuum and allow the filter/disk to soak for approx one minute. Apply vacuum and draw all of the toluene through the filter/disk. Repeat the wash step with approx 15 mL of acetone and allow the filter/disk to air dry.

12.2.1.3 Re-wet the filter/disk with approximately 15 mL of methanol, allowing the filter/disk to soak for approximately one minute. Pull the methanol through the filter/disk using the vacuum, but retain a layer of methanol approximately 1 mm thick on the filter. Do not allow the disk to go dry from this point until the end of the extraction.

12.2.1.4 Rinse the filter/disk with two 50-mL portions of reagent water by adding the water to the reservoir and pulling most through, leaving a layer of water on the surface of the filter.

12.2.2 Extraction.

12.2.2.1 Pour the spiked sample (Section 11.4.2.2), blank (Section 11.4.2.4), or IPR/OPR aliquot (Section 11.4.2.5) into the reservoir and turn on the vacuum to begin the extraction. Adjust the vacuum to complete the extraction in no less than 10 minutes. For samples containing a high concentration of particles (suspended solids), filtration times may be eight hours or longer.

12.2.2.2 Before all of the sample has been pulled through the filter/disk, rinse the sample bottle with approximately 50 mL of reagent water to remove any solids, and pour into the reservoir. Pull through the filter/disk. Use additional reagent water rinses until all visible solids are removed.

12.2.2.3 Before all of the sample and rinses have been pulled through the filter/disk, rinse the sides of the reservoir with small portions of reagent water.

12.2.2.4 Allow the filter/disk to dry, then remove the filter and disk and place in a glass Petri dish. Extract the filter and disk per Section 12.3.

12.3 SDS Extraction of Samples Containing Particles, and of Filters and/or Disks.

12.3.1 Charge a clean extraction thimble (Section 6.4.2.2) with 5.0 g of 100/200 mesh silica (Section 7.5.1.1) topped with 100 g of quartz sand (Section 7.3.2).

NOTE: Do not disturb the silica layer throughout the extraction process.

12.3.2 Place the thimble in a clean extractor. Place 30–40 mL of toluene in the receiver and 200–250 mL of toluene in the flask.

12.3.3 Pre-extract the glassware by heating the flask until the toluene is boiling. When properly adjusted, one to two drops of toluene will fall per second from the condenser tip into the receiver. Extract the apparatus for a minimum of three hours.

12.3.4 After pre-extraction, cool and disassemble the apparatus. Rinse the thimble with toluene and allow to air dry.

12.3.5 Load the wet sample, filter, and/or disk from Section 11.4.3.6, 11.5.8, 11.6.4, 11.7.3, 11.7.4, or 12.2.2.4 and any nonaqueous liquid from Section 11.6.3 into the thimble and manually mix into the sand layer with a clean metal spatula, carefully breaking up any large lumps of sample.

12.3.6 Reassemble the pre-extracted SDS apparatus, and add a fresh charge of toluene to the receiver and reflux flask. Apply power to the heating mantle to begin refluxing. Adjust the reflux rate to match the rate of percolation through the sand and silica beds until water removal lessens the restriction to toluene flow. Frequently check the apparatus for foaming during the first two hours of extraction. If foaming occurs, reduce the reflux rate until foaming subsides.

12.3.7 Drain the water from the receiver at one to two hours and eight to nine hours, or sooner if the receiver fills with water. Reflux the sample for a total of 16–24 hours. Cool and disassemble the apparatus. Record the total volume of water collected.

12.3.8 Remove the distilling flask. Drain the water from the Dean-Stark receiver and add any toluene in the receiver to the extract in the flask.

12.3.9 Concentrate the extract using one of the macro-concentration procedures in Section 12.6 per the following:

12.3.9.1 Extracts from the particles in an aqueous sample containing less than 1% solids (Section 11.4.3.6).

12.3.9.1.1 Concentrate the extract to approximately 5 mL using the rotary evaporator or heating mantle procedures in Section 12.6.1 or 12.6.2.

12.3.9.1.2 Quantitatively transfer the extract through the sodium sulfate (Section 12.1.3) into the apparatus that was set aside (Section 12.1.4.2) and reconcentrate to the level of the toluene.

12.3.9.1.3 Adjust to approximately 10 mL with hexane, transfer to a 250 mL separatory funnel, and proceed with back-extraction (Section 12.5).

12.3.9.2 Extracts from particles (Sections 11.5 through 11.6) or from the SPE filter and disk (Section 12.2.2.4)—Concentrate to approximately 10 mL using the rotary evaporator or heating mantle (Section 12.6.1 or 12.6.2), transfer to a 250 mL separatory funnel, and proceed with back-extraction (Section 12.5).

12.4 Extraction of Tissue—Two procedures are provided for tissue extraction.

12.4.1 Soxhlet extraction (Reference 21).

12.4.1.1 Add 30–40 g of powdered anhydrous sodium sulfate to each of the beakers (Section 11.8.4) and mix thoroughly. Cover the beakers with aluminum foil and allow to equilibrate for 12–24 hours. Remix prior to extraction to prevent clumping.

12.4.1.2 Assemble and pre-extract the Soxhlet apparatus per Sections 12.3.1 through 12.3.4, except use the methylene chloride:hexane (1:1) mixture for the pre-extraction and rinsing and omit the quartz sand. The Dean-Stark moisture trap may also be omitted, if desired.

12.4.1.3 Reassemble the pre-extracted Soxhlet apparatus and add a fresh charge of methylene chloride:hexane to the reflux flask.

12.4.1.4 Transfer the sample/sodium sulfate mixture (Section 12.4.1.1) to the Soxhlet thimble, and install the thimble in the Soxhlet apparatus.

12.4.1.5 Rinse the beaker with several portions of solvent mixture and add to the thimble. Fill the thimble/receiver with solvent. Extract for 18–24 hours.

12.4.1.6 After extraction, cool and disassemble the apparatus.

12.4.1.7 Quantitatively transfer the extract to a macro-concentration device (Section 12.6), and concentrate to near dryness. Set aside the concentration apparatus for reuse.

12.4.1.8 Complete the removal of the solvent using the nitrogen blowdown procedure (Section 12.7) and a water bath temperature of 60 °C. Weigh the receiver, record the weight, and return the receiver to the blowdown apparatus, concentrating the residue until a constant weight is obtained.

12.4.1.9 Percent lipid determination—The lipid content is determined by extraction of tissue with the same solvent system (methylene chloride:hexane) that was used in EPA's National Dioxin Study (Reference 22) so that lipid contents are consistent with that study.

12.4.1.9.1 Redissolve the residue in the receiver in hexane and spike 1.0 mL of the cleanup standard (Section 7.11) into the solution.

12.4.1.9.2 Transfer the residue/hexane to the anthropogenic isolation column (Section 13.7.1) or bottle for the acidified silica gel batch cleanup (Section 13.7.2), retaining the boiling chips in the concentration apparatus. Use several rinses to assure that all material is transferred. If necessary, sonicate or heat the receiver slightly to assure that all material is re-dissolved. Allow the receiver to dry. Weigh the receiver and boiling chips.

12.4.1.9.3 Calculate the lipid content to the nearest three significant figures as follows:

$$\text{Percent lipid} = \frac{\text{Weight of residue (g)}}{\text{Weight of tissue (g)}} \times 100$$

12.4.1.9.4 It is not necessary to determine the lipid content of the blank, IPR, or OPR aliquots.

12.4.2 HCl digestion/extraction and concentration (References 23–26).

12.4.2.1 Add 200 mL of 6 N HCl and 200 mL of methylene chloride:hexane (1:1) to the sample and QC aliquots (Section 11.8.4).

12.4.2.2 Cap and shake each bottle one to three times. Loosen the cap in a hood to vent excess pressure. Shake each bottle for 10–30 seconds and vent.

12.4.2.3 Tightly cap and place on shaker. Adjust the shaker action and speed so that the acid, solvent, and tissue are in constant motion. However, take care to avoid such violent action that the bottle may be dislodged from the shaker. Shake for 12–24 hours.

12.4.2.4 After digestion, remove the bottles from the shaker. Allow the bottles to stand so that the solvent and acid layers separate.

12.4.2.5 Decant the solvent through a glass funnel with glass-fiber filter (Sections 6.5.2 through 6.5.3) containing approximately 10 g of granular anhydrous sodium sulfate (Section 7.2.1) into a macro-concentration apparatus (Section 12.6). Rinse the contents of the bottle with two 25 mL portions of hexane and pour through the sodium sulfate into the apparatus.

12.4.2.6 Concentrate the solvent to near dryness using a macro-concentration procedure (Section 12.6).

12.4.2.7 Complete the removal of the solvent using the nitrogen blowdown apparatus (Section 12.7) and a water bath temperature of 60 °C. Weigh the receiver, record the weight, and return the receiver to the blowdown apparatus, concentrating the residue until a constant weight is obtained.

12.4.2.8 Percent lipid determination—The lipid content is determined in the same solvent system [methylene chloride:hexane (1:1)] that was used in EPA's National Dioxin Study (Reference 22) so that lipid contents are consistent with that study.

12.4.2.8.1 Redissolve the residue in the receiver in hexane and spike 1.0 mL of the cleanup standard (Section 7.11) into the solution.

12.4.2.8.2 Transfer the residue/hexane to the narrow-mouth 100–200 mL bottle retaining the boiling chips in the receiver. Use several rinses to assure that all material is transferred, to a maximum hexane volume of approximately 70 mL. Allow the receiver to dry. Weigh the receiver and boiling chips.

12.4.2.8.3 Calculate the percent lipid per Section 12.4.1.9.3. It is not necessary to determine the lipid content of the blank, IPR, or OPR aliquots.

12.4.2.9 Clean up the extract per Section 13.7.3.

12.5 Back-Extraction with Base and Acid.

12.5.1 Spike 1.0 mL of the cleanup standard (Section 7.11) into the separatory funnels containing the sample and QC extracts from Section 12.1.4.1, 12.3.9.1.3, or 12.3.9.2.

12.5.2 Partition the extract against 50 mL of potassium hydroxide solution (Section 7.1.1). Shake for two minutes with periodic venting into a hood. Remove and discard the aqueous layer. Repeat the base washing until no color is visible in the aqueous layer, to a maximum of four washings. Minimize contact time between the extract and the base to prevent degradation of the CDDs/CDFs. Stronger potassium hydroxide solutions may be employed for back-extraction, provided that the laboratory meets the specifications for labeled compound recovery and demonstrates acceptable performance using the procedure in Section 9.2.

12.5.3 Partition the extract against 50 mL of sodium chloride solution (Section 7.1.4) in the same way as with base. Discard the aqueous layer.

12.5.4 Partition the extract against 50 mL of sulfuric acid (Section 7.1.2) in the same way as with base. Repeat the acid washing until no color is visible in the aqueous layer, to a maximum of four washings.

12.5.5 Repeat the partitioning against sodium chloride solution and discard the aqueous layer.

12.5.6 Pour each extract through a drying column containing 7–10 cm of granular anhydrous sodium sulfate (Section 7.2.1). Rinse the separatory funnel with 30–50 mL of solvent, and pour through the drying column. Collect each extract in a round-bottom flask. Re-concentrate the sample and QC aliquots per Sections 12.6 through 12.7, and clean up the samples and QC aliquots per Section 13.

12.6 Macro-Concentration—Extracts in toluene are concentrated using a rotary evaporator or a heating mantle; extracts in methylene chloride or hexane are concentrated using a rotary evaporator, heating mantle, or Kuderna-Danish apparatus.

12.6.1 Rotary evaporation—Concentrate the extracts in separate round-bottom flasks.

12.6.1.1 Assemble the rotary evaporator according to manufacturer's instructions, and warm the water bath to 45 °C. On a daily basis, preclean the rotary evaporator by concentrating 100 mL of clean extraction solvent through the system. Archive both the concentrated solvent and the solvent in the catch flask for a contamination check if necessary. Between samples, three 2–3 mL aliquots of solvent should be rinsed down the feed tube into a waste beaker.

12.6.1.2 Attach the round-bottom flask containing the sample extract to the rotary evaporator. Slowly apply vacuum to the system, and begin rotating the sample flask.

12.6.1.3 Lower the flask into the water bath, and adjust the speed of rotation and the temperature as required to complete concentration in 15–20 minutes. At the proper rate of concentration, the flow of solvent into the receiving flask will be steady, but no bumping or visible boiling of the extract will occur.

NOTE: If the rate of concentration is too fast, analyte loss may occur.

12.6.1.4 When the liquid in the concentration flask has reached an apparent volume of approximately 2 mL, remove the flask from the water bath and stop the rotation. Slowly and carefully admit air into the system. Be sure not to open the valve so quickly that the sample is blown out of the flask. Rinse the feed tube with approximately 2 mL of solvent.

12.6.1.5 Proceed to Section 12.6.4 for preparation for back-extraction or micro-concentration and solvent exchange.

12.6.2 Heating mantle—Concentrate the extracts in separate round-bottom flasks.

12.6.2.1 Add one or two clean boiling chips to the round-bottom flask, and attach a three-ball macro Snyder column. Prewet the column by adding approximately 1 mL of solvent through the top. Place the round-bottom flask in a heating mantle, and apply heat as required to complete the concentration in 15–20 minutes. At the proper rate of distillation, the balls of the column will actively chatter, but the chambers will not flood.

12.6.2.2 When the liquid has reached an apparent volume of approximately 10 mL, remove the round-bottom flask from the heating mantle and allow the solvent to drain and cool for at least 10 minutes. Remove the Snyder column and rinse the glass joint into the receiver with small portions of solvent.

12.6.2.3 Proceed to Section 12.6.4 for preparation for back-extraction or micro-concentration and solvent exchange.

12.6.3 Kuderna-Danish (K-D)—Concentrate the extracts in separate 500 mL K-D flasks equipped with 10 mL concentrator tubes. The K-D technique is used for solvents such as methylene chloride and hexane. Toluene is difficult to concentrate using the K-D technique unless a water bath fed by a steam generator is used.

12.6.3.1 Add one to two clean boiling chips to the receiver. Attach a three-ball macro Snyder column. Prewet the column by adding approximately 1 mL of solvent through the top. Place the K-D apparatus in a hot water bath so that the entire lower rounded surface of the flask is bathed with steam.

12.6.3.2 Adjust the vertical position of the apparatus and the water temperature as required to complete the concentration in 15–20 minutes. At the proper rate of distillation, the balls of the column will actively chatter but the chambers will not flood.

12.6.3.3 When the liquid has reached an apparent volume of 1 mL, remove the K-D apparatus from the bath and allow the solvent to drain and cool for at least 10 minutes. Remove the Snyder column and rinse the flask and its lower joint into the concentrator tube with 1–2 mL of solvent. A 5 mL syringe is recommended for this operation.

12.6.3.4 Remove the three-ball Snyder column, add a fresh boiling chip, and attach a two-ball micro Snyder column to the concentrator tube. Prewet the column by adding approximately 0.5 mL of solvent through the top. Place the apparatus in the hot water bath.

12.6.3.5 Adjust the vertical position and the water temperature as required to complete the concentration in 5–10 minutes. At the proper rate of distillation, the balls of the column will actively chatter but the chambers will not flood.

12.6.3.6 When the liquid reaches an apparent volume of 0.5 mL, remove the apparatus from the water bath and allow to drain and cool for at least 10 minutes.

12.6.3.7 Proceed to 12.6.4 for preparation for back-extraction or micro-concentration and solvent exchange.

12.6.4 Preparation for back-extraction or micro-concentration and solvent exchange.

12.6.4.1 For back-extraction (Section 12.5), transfer the extract to a 250 mL separatory funnel. Rinse the concentration vessel with small portions of hexane, adjust the hexane volume in the separatory funnel to 10–20 mL, and proceed to back-extraction (Section 12.5).

12.6.4.2 For determination of the weight of residue in the extract, or for clean-up procedures other than back-extraction, transfer the extract to a blowdown vial using two to three rinses of solvent. Proceed with micro-concentration and solvent exchange (Section 12.7).

12.7 Micro-Concentration and Solvent Exchange.

12.7.1 Extracts to be subjected to GPC or HPLC cleanup are exchanged into methylene chloride. Extracts to be cleaned up using silica gel, alumina, carbon, and/or Florisil are exchanged into hexane.

12.7.2 Transfer the vial containing the sample extract to a nitrogen blowdown device. Adjust the flow of nitrogen so that the surface of the solvent is just visibly disturbed.

NOTE: A large vortex in the solvent may cause analyte loss.

12.7.3 Lower the vial into a 45 °C water bath and continue concentrating.

12.7.3.1 If the extract is to be concentrated to dryness for weight determination (Sections 12.4.1.8, 12.4.2.7, and 13.7.1.4), blow dry until a constant weight is obtained.

12.7.3.2 If the extract is to be concentrated for injection into the GC/MS or the

solvent is to be exchanged for extract clean-up, proceed as follows:

12.7.4 When the volume of the liquid is approximately 100 L, add 2–3 mL of the desired solvent (methylene chloride for GPC and HPLC, or hexane for the other cleanups) and continue concentration to approximately 100 μ L. Repeat the addition of solvent and concentrate once more.

12.7.5 If the extract is to be cleaned up by GPC, adjust the volume of the extract to 5.0 mL with methylene chloride. If the extract is to be cleaned up by HPLC, further concentrate the extract to 30 μ L. Proceed with GPC or HPLC cleanup (Section 13.2 or 13.6, respectively).

12.7.6 If the extract is to be cleaned up by column chromatography (alumina, silica gel, Caropak/Celite, or Florisil), bring the final volume to 1.0 mL with hexane. Proceed with column cleanups (Sections 13.3 through 13.5 and 13.8).

12.7.7 If the extract is to be concentrated for injection into the GC/MS (Section 14), quantitatively transfer the extract to a 0.3 mL conical vial for final concentration, rinsing the larger vial with hexane and adding the rinse to the conical vial. Reduce the volume to approximately 100 μ L. Add 10 μ L of nonane to the vial, and evaporate the solvent to the level of the nonane. Seal the vial and label with the sample number. Store in the dark at room temperature until ready for GC/MS analysis. If GC/MS analysis will not be performed on the same day, store the vial at < -10 °C.

13.0 Extract Cleanup

13.1 Cleanup may not be necessary for relatively clean samples (e.g., treated effluents, groundwater, drinking water). If particular circumstances require the use of a cleanup procedure, the analyst may use any or all of the procedures below or any other appropriate procedure. Before using a cleanup procedure, the analyst must demonstrate that the requirements of Section 9.2 can be met using the cleanup procedure. If only 2,3,7,8-TCDD and 2,3,7,8-TCDF are to be determined, the cleanup procedures may be optimized for isolation of these two compounds.

13.1.1 Gel permeation chromatography (Section 13.2) removes high molecular weight interferences that cause GC column performance to degrade. It should be used for all soil and sediment extracts and may be used for water extracts that are expected to contain high molecular weight organic compounds (e.g., polymeric materials, humic acids).

13.1.2 Acid, neutral, and basic silica gel (Section 13.3), alumina (Section 13.4), and Florisil (Section 13.8) are used to remove nonpolar and polar interferences. Alumina and Florisil are used to remove chlorodiphenyl ethers.

13.1.3 Caropak/Celite (Section 13.5) is used to remove nonpolar interferences.

13.1.4 HPLC (Section 13.6) is used to provide specificity for the 2,3,7,8-substituted and other CDD and CDF isomers.

13.1.5 The anthropogenic isolation column (Section 13.7.1), acidified silica gel batch adsorption procedure (Section 13.7.2), and sulfuric acid and base back-extraction (Section 13.7.3) are used for removal of lipids from tissue samples.

13.2 Gel Permeation Chromatography (GPC).

13.2.1 Column packing.

13.2.1.1 Place 70–75 g of SX-3 Bio-beads (Section 6.7.1.1) in a 400–500 mL beaker.

13.2.1.2 Cover the beads with methylene chloride and allow to swell overnight (a minimum of 12 hours).

13.2.1.3 Transfer the swelled beads to the column (Section 6.7.1.1) and pump solvent through the column, from bottom to top, at 4.5–5.5 mL/minute prior to connecting the column to the detector.

13.2.1.4 After purging the column with solvent for one to two hours, adjust the column head pressure to 7–10 psig and purge for four to five hours to remove air. Maintain a head pressure of 7–10 psig. Connect the column to the detector (Section 6.7.1.4).

13.2.2 Column calibration.

13.2.2.1 Load 5 mL of the calibration solution (Section 7.4) into the sample loop.

13.2.2.2 Inject the calibration solution and record the signal from the detector. The elution pattern will be corn oil, bis(2-ethyl hexyl)phthalate, pentachlorophenol, perylene, and sulfur.

13.2.2.3 Set the “dump time” to allow >85% removal of the corn oil and >85% collection of the phthalate.

13.2.2.4 Set the “collect time” to the peak minimum between perylene and sulfur.

13.2.2.5 Verify the calibration with the calibration solution after every 20 extracts. Calibration is verified if the recovery of the pentachlorophenol is greater than 85%. If calibration is not verified, the system shall be recalibrated using the calibration solution, and the previous 20 samples shall be re-extracted and cleaned up using the calibrated GPC system.

13.2.3 Extract cleanup—GPC requires that the column not be overloaded. The column specified in this method is designed to handle a maximum of 0.5 g of high molecular weight material in a 5 mL extract. If the extract is known or expected to contain more than 0.5 g, the extract is split into aliquots for GPC, and the aliquots are combined after elution from the column. The residue content of the extract may be obtained gravimetrically by evaporating the solvent from a 50 μ L aliquot.

13.2.3.1 Filter the extract or load through the filter holder (Section 6.7.1.3) to remove the particles. Load the 5.0 mL extract onto the column.

13.2.3.2 Elute the extract using the calibration data determined in Section 13.2.2. Collect the eluate in a clean 400-500 mL beaker.

13.2.3.3 Rinse the sample loading tube thoroughly with methylene chloride between extracts to prepare for the next sample.

13.2.3.4 If a particularly dirty extract is encountered, a 5.0 mL methylene chloride blank shall be run through the system to check for carry-over.

13.2.3.5 Concentrate the eluate per Sections 12.6 and 12.7 for further cleanup or injection into the GC/MS.

13.3 Silica Gel Cleanup.

13.3.1 Place a glass-wool plug in a 15 mm ID chromatography column (Section 6.7.4.2). Pack the column bottom to top with: 1 g silica gel (Section 7.5.1.1), 4 g basic silica gel (Section 7.5.1.3), 1 g silica gel, 8 g acid silica gel (Section 7.5.1.2), 2 g silica gel, and 4 g granular anhydrous sodium sulfate (Section 7.2.1). Tap the column to settle the adsorbents.

13.3.2 Pre-elute the column with 50-100 mL of hexane. Close the stopcock when the hexane is within 1 mm of the sodium sulfate. Discard the eluate. Check the column for channeling. If channeling is present, discard the column and prepare another.

13.3.3 Apply the concentrated extract to the column. Open the stopcock until the extract is within 1 mm of the sodium sulfate.

13.3.4 Rinse the receiver twice with 1 mL portions of hexane, and apply separately to the column. Elute the CDDs/CDFs with 100 mL hexane, and collect the eluate.

13.3.5 Concentrate the eluate per Sections 12.6 and 12.7 for further cleanup or injection into the HPLC or GC/MS.

13.3.6 For extracts of samples known to contain large quantities of other organic compounds (such as paper mill effluents), it may be advisable to increase the capacity of the silica gel column. This may be accomplished by increasing the strengths of the acid and basic silica gels. The acid silica gel (Section 7.5.1.2) may be increased in strength to as much as 44% w/w (7.9 g sulfuric acid added to 10 g silica gel). The basic silica gel (Section 7.5.1.3) may be increased in strength to as much as 33% w/w (50 mL 1N NaOH added to 100 g silica gel), or the potassium silicate (Section 7.5.1.4) may be used.

NOTE: The use of stronger acid silica gel (44% w/w) may lead to charring of organic compounds in some extracts. The charred material may retain some of the analytes and lead to lower recoveries of CDDs/CDFs. Increasing the strengths of the acid and basic silica gel may also require different volumes of hexane than those specified above to elute the analytes off the column. Therefore, the performance of the method after such modifications must be verified by the procedure in Section 9.2.

13.4 Alumina Cleanup.

13.4.1 Place a glass-wool plug in a 15 mm ID chromatography column (Section 6.7.4.2).

13.4.2 If using acid alumina, pack the column by adding 6 g acid alumina (Section 7.5.2.1). If using basic alumina, substitute 6 g basic alumina (Section 7.5.2.2). Tap the column to settle the adsorbents.

13.4.3 Pre-elute the column with 50-100 mL of hexane. Close the stopcock when the hexane is within 1 mm of the alumina.

13.4.4 Discard the eluate. Check the column for channeling. If channeling is present, discard the column and prepare another.

13.4.5 Apply the concentrated extract to the column. Open the stopcock until the extract is within 1 mm of the alumina.

13.4.6 Rinse the receiver twice with 1 mL portions of hexane and apply separately to the column. Elute the interfering compounds with 100 mL hexane and discard the eluate.

13.4.7 The choice of eluting solvents will depend on the choice of alumina (acid or basic) made in Section 13.4.2.

13.4.7.1 If using acid alumina, elute the CDDs/CDFs from the column with 20 mL methylene chloride:hexane (20:80 v/v). Collect the eluate.

13.4.7.2 If using basic alumina, elute the CDDs/CDFs from the column with 20 mL methylene chloride:hexane (50:50 v/v). Collect the eluate.

13.4.8 Concentrate the eluate per Sections 12.6 and 12.7 for further cleanup or injection into the HPLC or GC/MS.

13.5 Carbon Column.

13.5.1 Cut both ends from a 10 mL disposable serological pipet (Section 6.7.3.2) to produce a 10 cm column. Fire-polish both ends and flare both ends if desired. Insert a glass-wool plug at one end, and pack the column with 0.55 g of Carbopak/Celite (Section 7.5.3.3) to form an adsorbent bed approximately 2 cm long. Insert a glass-wool plug on top of the bed to hold the adsorbent in place.

13.5.2 Pre-elute the column with 5 mL of toluene followed by 2 mL of methylene chloride:methanol:toluene (15:4:1 v/v), 1 mL of methylene chloride:cyclohexane (1:1 v/v), and 5 mL of hexane. If the flow rate of eluate exceeds 0.5 mL/minute, discard the column.

13.5.3 When the solvent is within 1 mm of the column packing, apply the sample extract to the column. Rinse the sample container twice with 1 mL portions of hexane and apply separately to the column. Apply 2 mL of hexane to complete the transfer.

13.5.4 Elute the interfering compounds with two 3 mL portions of hexane, 2 mL of methylene chloride:cyclohexane (1:1 v/v), and 2 mL of methylene chloride:methanol:toluene (15:4:1 v/v). Discard the eluate.

13.5.5 Invert the column, and elute the CDDs/CDFs with 20 mL of toluene. If carbon particles are present in the eluate, filter through glass-fiber filter paper.

13.5.6 Concentrate the eluate per Sections 12.6 and 12.7 for further cleanup or injection into the HPLC or GC/MS.

13.6 HPLC (Reference 6).

13.6.1 Column calibration.

13.6.1.1 Prepare a calibration standard containing the 2,3,7,8-substituted isomers and/or other isomers of interest at a concentration of approximately 500 pg/ μ L in methylene chloride.

13.6.1.2 Inject 30 μ L of the calibration solution into the HPLC and record the signal from the detector. Collect the eluant for reuse. The elution order will be the tetra-through octa-isomers.

13.6.1.3 Establish the collection time for the tetra-isomers and for the other isomers of interest. Following calibration, flush the injection system with copious quantities of methylene chloride, including a minimum of five 50 μ L injections while the detector is monitored, to ensure that residual CDDs/CDFs are removed from the system.

13.6.1.4 Verify the calibration with the calibration solution after every 20 extracts. Calibration is verified if the recovery of the CDDs/CDFs from the calibration standard (Section 13.6.1.1) is 75–125% compared to the calibration (Section 13.6.1.2). If calibration is not verified, the system shall be recalibrated using the calibration solution, and the previous 20 samples shall be re-extracted and cleaned up using the calibrated system.

13.6.2 Extract cleanup—HPLC requires that the column not be overloaded. The column specified in this method is designed to handle a maximum of 30 μ L of extract. If the extract cannot be concentrated to less than 30 μ L, it is split into fractions and the fractions are combined after elution from the column.

13.6.2.1 Rinse the sides of the vial twice with 30 μ L of methylene chloride and reduce to 30 μ L with the evaporation apparatus (Section 12.7).

13.6.2.2 Inject the 30 μ L extract into the HPLC.

13.6.2.3 Elute the extract using the calibration data determined in Section 13.6.1. Collect the fraction(s) in a clean 20 mL concentrator tube containing 5 mL of hexane:acetone (1:1 v/v).

13.6.2.4 If an extract containing greater than 100 ng/mL of total CDD or CDF is encountered, a 30 μ L methylene chloride blank shall be run through the system to check for carry-over.

13.6.2.5 Concentrate the eluate per Section 12.7 for injection into the GC/MS.

13.7 Cleanup of Tissue Lipids—Lipids are removed from the Soxhlet extract using either the anthropogenic isolation column (Section 13.7.1) or acidified silica gel (Section 13.7.2), or are removed from the HCl digested extract using sulfuric acid and base back-extraction (Section 13.7.3).

13.7.1 Anthropogenic isolation column (References 22 and 27)—Used for removal of lipids from the Soxhlet/SDS extraction (Section 12.4.1).

13.7.1.1 Prepare the column as given in Section 7.5.4.

13.7.1.2 Pre-elute the column with 100 mL of hexane. Drain the hexane layer to the top of the column, but do not expose the sodium sulfate.

13.7.1.3 Load the sample and rinses (Section 12.4.1.9.2) onto the column by draining each portion to the top of the bed. Elute the CDDs/CDFs from the column into the apparatus used for concentration (Section 12.4.1.7) using 200 mL of hexane.

13.7.1.4 Concentrate the cleaned up extract (Sections 12.6 through 12.7) to constant weight per Section 12.7.3.1. If more than 500 mg of material remains, repeat the cleanup using a fresh anthropogenic isolation column.

13.7.1.5 Redissolve the extract in a solvent suitable for the additional cleanups to be used (Sections 13.2 through 13.6 and 13.8).

13.7.1.6 Spike 1.0 mL of the cleanup standard (Section 7.11) into the residue/solvent.

13.7.1.7 Clean up the extract using the procedures in Sections 13.2 through 13.6 and 13.8. Alumina (Section 13.4) or Florisil (Section 13.8) and carbon (Section 13.5) are recommended as minimum additional cleanup steps.

13.7.1.8 Following cleanup, concentrate the extract to 10 μ L as described in Section 12.7 and proceed with the analysis in Section 14.

13.7.2 Acidified silica gel (Reference 28)—Procedure alternate to the anthropogenic isolation column (Section 13.7.1) that is used for removal of lipids from the Soxhlet/SDS extraction (Section 12.4.1).

13.7.2.1 Adjust the volume of hexane in the bottle (Section 12.4.1.9.2) to approximately 200 mL.

13.7.2.2 Spike 1.0 mL of the cleanup standard (Section 7.11) into the residue/solvent.

13.7.2.3 Drop the stirring bar into the bottle, place the bottle on the stirring plate, and begin stirring.

13.7.2.4 Add 30–100 g of acid silica gel (Section 7.5.1.2) to the bottle while stirring, keeping the silica gel in motion. Stir for two to three hours.

NOTE: 30 grams of silica gel should be adequate for most samples and will minimize contamination from this source.

13.7.2.5 After stirring, pour the extract through approximately 10 g of granular anhydrous sodium sulfate (Section 7.2.1) contained in a funnel with glass-fiber filter into a macro contraction device (Section 12.6). Rinse the bottle and sodium sulfate with hexane to complete the transfer.

13.7.2.6 Concentrate the extract per Sections 12.6 through 12.7 and clean up the extract using the procedures in Sections 13.2 through 13.6 and 13.8. Alumina (Section 13.4) or Florisil (Section 13.8) and carbon (Section 13.5) are recommended as minimum additional cleanup steps.

13.7.3 Sulfuric acid and base back-extraction. Used with HCl digested extracts (Section 12.4.2).

13.7.3.1 Spike 1.0 mL of the cleanup standard (Section 7.11) into the residue/solvent (Section 12.4.2.8.2).

13.7.3.2 Add 10 mL of concentrated sulfuric acid to the bottle. Immediately cap and shake one to three times. Loosen cap in a hood to vent excess pressure. Cap and shake the bottle so that the residue/solvent is exposed to the acid for a total time of approximately 45 seconds.

13.7.3.3 Decant the hexane into a 250 mL separatory funnel making sure that no acid is transferred. Complete the quantitative transfer with several hexane rinses.

13.7.3.4 Back extract the solvent/residue with 50 mL of potassium hydroxide solution per Section 12.5.2, followed by two reagent water rinses.

13.7.3.5 Drain the extract through a filter funnel containing approximately 10 g of granular anhydrous sodium sulfate in a glass-fiber filter into a macro concentration device (Section 12.6).

13.7.3.6 Concentrate the cleaned up extract to a volume suitable for the additional cleanups given in Sections 13.2 through 13.6 and 13.8. Gel permeation chromatography (Section 13.2), alumina (Section 13.4) or Florisil (Section 13.8), and Carbowax/Celite (Section 13.5) are recommended as minimum additional cleanup steps.

13.7.3.7 Following cleanup, concentrate the extract to 10 L as described in Section 12.7 and proceed with analysis per Section 14.

13.8 Florisil Cleanup (Reference 29).

13.8.1 Pre-elute the activated Florisil column (Section 7.5.3) with 10 mL of methylene chloride followed by 10 mL of hexane:methylene chloride (98:2 v/v) and discard the solvents.

13.8.2 When the solvent is within 1 mm of the packing, apply the sample extract (in hexane) to the column. Rinse the sample container twice with 1 mL portions of hexane and apply to the column.

13.8.3 Elute the interfering compounds with 20 mL of hexane:methylene chloride (98:2) and discard the eluate.

13.8.4 Elute the CDDs/CDFs with 35 mL of methylene chloride and collect the eluate. Concentrate the eluate per Sections 12.6 through 12.7 for further cleanup or for injection into the HPLC or GC/MS.

14.0 HRGC/HRMS Analysis

14.1 Establish the operating conditions given in Section 10.1.

14.2 Add 10 μ L of the appropriate internal standard solution (Section 7.12) to the sample extract immediately prior to injection to minimize the possibility of loss by evaporation, adsorption, or reaction. If an extract is to be reanalyzed and evaporation has occurred, do not add more instrument internal standard solution. Rather, bring the extract back to its previous volume (e.g., 19 L) with pure nonane only (18 L if 2 L injections are used).

14.3 Inject 1.0 μ L or 2.0 μ L of the concentrated extract containing the internal standard solution, using on-column or splitless injection. The volume injected must be identical to the volume used for calibration (Section 10). Start the GC column initial isothermal hold upon injection. Start MS data collection after the solvent peak elutes. Stop data collection after the OCDD and OCDF have eluted. If only 2,3,7,8-TCDD and 2,3,7,8-TCDF are to be determined, stop data collection after elution of these compounds. Return the column to the initial temperature for analysis of the next extract or standard.

15.0 System and Laboratory Performance

15.1 At the beginning of each 12-hour shift during which analyses are performed, GC/MS system performance and calibration are verified for all CDDs/CDFs and labeled compounds. For these tests, analysis of the CS3 calibration verification (VER) standard (Section 7.13 and Table 4) and the isomer specificity test standards (Section 7.15 and Table 5) shall be used to verify all performance criteria. Adjustment and/or recalibration (Section 10) shall be performed until all performance criteria are met. Only after all performance criteria are met may samples, blanks, IPRs, and OPRs be analyzed.

15.2 MS Resolution—A static resolving power of at least 10,000 (10% valley definition) must be demonstrated at the appropriate m/z before any analysis is performed. Static resolving power checks must be performed at the beginning and at the end of each 12-hour shift according to procedures in Section 10.1.2. Corrective actions must be implemented whenever the resolving power does not meet the requirement.

15.3 Calibration Verification.

15.3.1 Inject the VER standard using the procedure in Section 14.

15.3.2 The m/z abundance ratios for all CDDs/CDFs shall be within the limits in Table 9; otherwise, the mass spectrometer shall be adjusted until the m/z abundance ratios fall within the limits specified, and the verification test shall be repeated. If the adjustment alters the resolution of the mass spectrometer, resolution shall be verified (Section 10.1.2) prior to repeat of the verification test.

15.3.3 The peaks representing each CDD/CDF and labeled compound in the VER

standard must be present with S/N of at least 10; otherwise, the mass spectrometer shall be adjusted and the verification test repeated.

15.3.4 Compute the concentration of each CDD/CDF compound by isotope dilution (Section 10.5) for those compounds that have labeled analogs (Table 1). Compute the concentration of the labeled compounds by the internal standard method (Section 10.6). These concentrations are computed based on the calibration data in Section 10.

15.3.5 For each compound, compare the concentration with the calibration verification limit in Table 6. If only 2,3,7,8-TCDD and 2,3,7,8-TCDF are to be determined, compare the concentration to the limit in Table 6a. If all compounds meet the acceptance criteria, calibration has been verified and analysis of standards and sample extracts may proceed. If, however, any compound fails its respective limit, the measurement system is not performing properly for that compound. In this event, prepare a fresh calibration standard or correct the problem causing the failure and repeat the resolution (Section 15.2) and verification (Section 15.3) tests, or recalibrate (Section 10).

15.4 Retention Times and GC Resolution.

15.4.1 Retention times.

15.4.1.1 Absolute—The absolute retention times of the $^{13}\text{C}_{12}$ -1,2,3,4-TCDD and $^{13}\text{C}_{12}$ -1,2,3,7,8,9-HxCDD GCMS internal standards in the verification test (Section 15.3) shall be within ± 15 seconds of the retention times obtained during calibration (Sections 10.2.1 and 10.2.4).

15.4.1.2 Relative—The relative retention times of CDDs/CDFs and labeled compounds in the verification test (Section 15.3) shall be within the limits given in Table 2.

15.4.2 GC resolution.

15.4.2.1 Inject the isomer specificity standards (Section 7.15) on their respective columns.

15.4.2.2 The valley height between 2,3,7,8-TCDD and the other tetra-dioxin isomers at m/z 319.8965, and between 2,3,7,8-TCDF and the other tetra-furan isomers at m/z 303.9016 shall not exceed 25% on their respective columns (Figures 6 and 7).

15.4.3 If the absolute retention time of any compound is not within the limits specified or if the 2,3,7,8-isomers are not resolved, the GC is not performing properly. In this event, adjust the GC and repeat the verification test (Section 15.3) or recalibrate (Section 10), or replace the GC column and either verify calibration or recalibrate.

15.5 Ongoing Precision and Recovery.

15.5.1 Analyze the extract of the ongoing precision and recovery (OPR) aliquot (Section 11.4.2.5, 11.5.4, 11.6.2, 11.7.4, or 11.8.3.2) prior to analysis of samples from the same batch.

15.5.2 Compute the concentration of each CDD/CDF by isotope dilution for those compounds that have labeled analogs (Section

10.5). Compute the concentration of 1,2,3,7,8,9-HxCDD, OCDF, and each labeled compound by the internal standard method (Section 10.6).

15.5.3 For each CDD/CDF and labeled compound, compare the concentration to the OPR limits given in Table 6. If only 2,3,7,8-TCDD and 2,3,7,8-TCDF are to be determined, compare the concentration to the limits in Table 6a. If all compounds meet the acceptance criteria, system performance is acceptable and analysis of blanks and samples may proceed. If, however, any individual concentration falls outside of the range given, the extraction/concentration processes are not being performed properly for that compound. In this event, correct the problem, re-prepare, extract, and clean up the sample batch and repeat the ongoing precision and recovery test (Section 15.5).

15.5.4 Add results that pass the specifications in Section 15.5.3 to initial and previous ongoing data for each compound in each matrix. Update QC charts to form a graphic representation of continued laboratory performance. Develop a statement of laboratory accuracy for each CDD/CDF in each matrix type by calculating the average percent recovery (R) and the standard deviation of percent recovery (S_R). Express the accuracy as a recovery interval from $R - 2S_R$ to $R + 2S_R$. For example, if $R = 95\%$ and $S_R = 5\%$, the accuracy is 85–105%.

15.6 Blank—Analyze the method blank extracted with each sample batch immediately following analysis of the OPR aliquot to demonstrate freedom from contamination and freedom from carryover from the OPR analysis. The results of the analysis of the blank must meet the specifications in Section 9.5.2 before sample analyses may proceed.

16.0 Qualitative Determination

A CDD, CDF, or labeled compound is identified in a standard, blank, or sample when all of the criteria in Sections 16.1 through 16.4 are met.

16.1 The signals for the two exact m/z 's in Table 8 must be present and must maximize within the same two seconds.

16.2 The signal-to-noise ratio (S/N) for the GC peak at each exact m/z must be greater than or equal to 2.5 for each CDD or CDF detected in a sample extract, and greater than or equal to 10 for all CDDs/CDFs in the calibration standard (Sections 10.2.3 and 15.3.3).

16.3 The ratio of the integrated areas of the two exact m/z 's specified in Table 8 must be within the limit in Table 9, or within $\pm 10\%$ of the ratio in the midpoint (CS3) calibration or calibration verification (VER), whichever is most recent.

16.4 The relative retention time of the peak for a 2,3,7,8-substituted CDD or CDF must be within the limit in Table 2. The retention time of peaks representing non-

2,3,7,8-substituted CDDs/CDFs must be within the retention time windows established in Section 10.3.

16.5 Confirmatory Analysis—Isomer specificity for 2,3,7,8-TCDF cannot be achieved on the DB-5 column. Therefore, any sample in which 2,3,7,8-TCDF is identified by analysis on a DB-5 column must have a confirmatory analysis performed on a DB-225, SP-2330, or equivalent GC column. The operating conditions in Section 10.1.1 may be adjusted to optimize the analysis on the second GC column, but the GC/MS must meet the mass resolution and calibration specifications in Section 10.

16.6 If the criteria for identification in Sections 16.1 through 16.5 are not met, the CDD or CDF has not been identified and the results may not be reported for regulatory compliance purposes. If interferences preclude identification, a new aliquot of sample must be extracted, further cleaned up, and analyzed.

17.0 Quantitative Determination

17.1 Isotope Dilution Quantitation—By adding a known amount of a labeled compound to every sample prior to extraction, correction for recovery of the CDD/CDF can be made because the CDD/CDF and its labeled analog exhibit similar effects upon extraction, concentration, and gas chromatography. Relative response (RR) values are used in conjunction with the initial calibration data described in Section 10.5 to determine concentrations directly, so long as labeled compound spiking levels are constant, using the following equation:

$$C_{\text{ex}} \text{ (ng/mL)} = \frac{(A_{1_n} + A_{2_n}) C_1}{(A_{1_1} + A_{2_1}) \text{RR}}$$

where:

C_{ex} = The concentration of the CDD/CDF in the extract, and the other terms are as defined in Section 10.5.2.

17.1.1 Because of a potential interference, the labeled analog of OCDF is not added to the sample. Therefore, OCDF is quantitated against labeled OCDD. As a result, the concentration of OCDF is corrected for the re-

covery of the labeled OCDD. In instances where OCDD and OCDF behave differently during sample extraction, concentration, and cleanup procedures, this may decrease the accuracy of the OCDF results. However, given the low toxicity of this compound relative to the other dioxins and furans, the potential decrease in accuracy is not considered significant.

17.1.2 Because $^{13}\text{C}_{12}$ -1,2,3,7,8,9-HxCDD is used as an instrument internal standard (*i.e.*, not added before extraction of the sample), it cannot be used to quantitate the 1,2,3,7,8,9-HxCDD by strict isotope dilution procedures. Therefore, 1,2,3,7,8,9-HxCDD is quantitated using the averaged response of the labeled analogs of the other two 2,3,7,8-substituted HxCDD's: 1,2,3,4,7,8-HxCDD and 1,2,3,6,7,8-HxCDD. As a result, the concentration of 1,2,3,7,8,9-HxCDD is corrected for the average recovery of the other two HxCDD's.

17.1.3 Any peaks representing non-2,3,7,8-substituted CDDs/CDFs are quantitated using an average of the response factors from all of the labeled 2,3,7,8-isomers at the same level of chlorination.

17.2 Internal Standard Quantitation and Labeled Compound Recovery.

17.2.1 Compute the concentrations of 1,2,3,7,8,9-HxCDD, OCDF, the ^{13}C -labeled analogs and the ^{37}Cl -labeled cleanup standard in the extract using the response factors determined from the initial calibration data (Section 10.6) and the following equation:

$$C_{\text{ex}} \text{ (ng/mL)} = \frac{(A_{1_s} + A_{2_s}) C_{\text{is}}}{(A_{1_{\text{is}}} + A_{2_{\text{is}}}) \text{RF}}$$

where:

C_{ex} = The concentration of the CDD/CDF in the extract, and the other terms are as defined in Section 10.6.1.

NOTE: There is only one m/z for the ^{37}Cl -labeled standard.

17.2.2 Using the concentration in the extract determined above, compute the percent recovery of the ^{13}C -labeled compounds and the ^{37}Cl -labeled cleanup standard using the following equation:

$$\text{Recovery (\%)} = \frac{\text{Concentration found (\mu g/mL)}}{\text{Concentration spiked (\mu g/mL)}} \times 100$$

17.3 The concentration of a CDD/CDF in the solid phase of the sample is computed using the concentration of the compound in

the extract and the weight of the solids (Section 11.5.1), as follows:

$$\text{Concentration in solid (ng/kg)} = \frac{(C_{\text{ex}} \times V_{\text{ex}})}{W_s}$$

where:

C_{ex} = The concentration of the compound in the extract.

V_{ex} = The extract volume in mL.

W_s = The sample weight (dry weight) in kg.

17.4 The concentration of a CDD/CDF in the aqueous phase of the sample is computed using the concentration of the compound in the extract and the volume of water extracted (Section 11.4 or 11.5), as follows:

$$\text{Concentration in aqueous phase (pg/L)} = \frac{(C_{\text{ex}} \times V_{\text{ex}})}{V_s}$$

where:

C_{ex} = The concentration of the compound in the extract.

V_{ex} = The extract volume in mL.

V_s = The sample volume in liters.

17.5 If the SICP area at either quantitation m/z for any compound exceeds the calibration range of the system, a smaller sample aliquot is extracted.

17.5.1 For aqueous samples containing 1% solids or less, dilute 100 mL, 10 mL, etc., of sample to 1 L with reagent water and re-prepare, extract, clean up, and analyze per Sections 11 through 14.

17.5.2 For samples containing greater than 1% solids, extract an amount of sample equal to $1/10$, $1/100$, etc., of the amount used in Section 11.5.1. Re-prepare, extract, clean up, and analyze per Sections 11 through 14.

17.5.3 If a smaller sample size will not be representative of the entire sample, dilute the sample extract by a factor of 10, adjust the concentration of the instrument internal standard to 100 pg/ μ L in the extract, and analyze an aliquot of this diluted extract by the internal standard method.

17.6 Results are reported to three significant figures for the CDDs/CDFs and labeled compounds found in all standards, blanks, and samples.

17.6.1 Reporting units and levels.

17.6.1.1 Aqueous samples—Report results in pg/L (parts-per-quadrillion).

17.6.1.2 Samples containing greater than 1% solids (soils, sediments, filter cake, compost)—Report results in ng/kg based on the dry weight of the sample. Report the percent solids so that the result may be corrected.

17.6.1.3 Tissues—Report results in ng/kg of wet tissue, not on the basis of the lipid content of the sample. Report the percent lipid content, so that the data user can calculate the concentration on a lipid basis if desired.

17.6.1.4 Reporting level.

17.6.1.4.1 Standards (VER, IPR, OPR) and samples—Report results at or above the minimum level (Table 2). Report results below the minimum level as not detected or as required by the regulatory authority.

17.6.1.4.2 Blanks—Report results above one-third the ML.

17.6.2 Results for CDDs/CDFs in samples that have been diluted are reported at the least dilute level at which the areas at the quantitation m/z's are within the calibration range (Section 17.5).

17.6.3 For CDDs/CDFs having a labeled analog, results are reported at the least dilute level at which the area at the quantitation m/z is within the calibration range (Section 17.5) and the labeled compound recovery is within the normal range for the method (Section 9.3 and Tables 6, 6a, 7, and 7a).

17.6.4 Additionally, if requested, the total concentration of all isomers in an individual level of chlorination (*i.e.*, total TCDD, total TCDF, total Paced, etc.) may be reported by summing the concentrations of all isomers identified in that level of chlorination, including both 2,3,7,8-substituted and non-2,3,7,8-substituted isomers.

18.0 Analysis of Complex Samples

18.1 Some samples may contain high levels (>10 ng/L; >1000 ng/kg) of the compounds of interest, interfering compounds, and/or polymeric materials. Some extracts will not concentrate to 10 μ L (Section 12.7); others may overload the GC column and/or mass spectrometer.

18.2 Analyze a smaller aliquot of the sample (Section 17.5) when the extract will not concentrate to 10 μ L after all cleanup procedures have been exhausted.

18.3 Chlorodiphenyl Ethers—If chromatographic peaks are detected at the retention time of any CDDs/CDFs in any of the m/z channels being monitored for the

chlorodiphenyl ethers (Table 8), cleanup procedures must be employed until these interferences are removed. Alumina (Section 13.4) and Florisil (Section 13.8) are recommended for removal of chlorodiphenyl ethers.

18.4 Recovery of Labeled Compounds—In most samples, recoveries of the labeled compounds will be similar to those from reagent water or from the alternate matrix (Section 7.6).

18.4.1 If the recovery of any of the labeled compounds is outside of the normal range (Table 7), a diluted sample shall be analyzed (Section 17.5).

18.4.2 If the recovery of any of the labeled compounds in the diluted sample is outside of normal range, the calibration verification standard (Section 7.13) shall be analyzed and calibration verified (Section 15.3).

18.4.3 If the calibration cannot be verified, a new calibration must be performed and the original sample extract reanalyzed.

18.4.4 If the calibration is verified and the diluted sample does not meet the limits for labeled compound recovery, the method does not apply to the sample being analyzed and the result may not be reported for regulatory compliance purposes. In this case, alternate extraction and cleanup procedures in this method must be employed to resolve the interference. If all cleanup procedures in this method have been employed and labeled compound recovery remains outside of the normal range, extraction and/or cleanup procedures that are beyond this scope of this method will be required to analyze these samples.

19.0 Pollution Prevention

19.1 The solvents used in this method pose little threat to the environment when managed properly. The solvent evaporation techniques used in this method are amenable to solvent recovery, and it is recommended that the laboratory recover solvents wherever feasible.

19.2 Standards should be prepared in volumes consistent with laboratory use to minimize disposal of standards.

20.0 Waste Management

20.1 It is the laboratory's responsibility to comply with all federal, state, and local regulations governing waste management, particularly the hazardous waste identification rules and land disposal restrictions, and to protect the air, water, and land by minimizing and controlling all releases from fume hoods and bench operations. Compliance is also required with any sewage discharge permits and regulations.

20.2 Samples containing HCl to pH <2 are hazardous and must be neutralized before being poured down a drain or must be handled as hazardous waste.

20.3 The CDDs/CDFs decompose above 800 °C. Low-level waste such as absorbent paper, tissues, animal remains, and plastic gloves may be burned in an appropriate incinerator. Gross quantities (milligrams) should be packaged securely and disposed of through commercial or governmental channels that are capable of handling extremely toxic wastes.

20.4 Liquid or soluble waste should be dissolved in methanol or ethanol and irradiated with ultraviolet light with a wavelength shorter than 290 nm for several days. Use F40 BL or equivalent lamps. Analyze liquid wastes, and dispose of the solutions when the CDDs/CDFs can no longer be detected.

20.5 For further information on waste management, consult "The Waste Management Manual for Laboratory Personnel" and "Less is Better—Laboratory Chemical Management for Waste Reduction," available from the American Chemical Society's Department of Government Relations and Science Policy, 1155 16th Street N.W., Washington, D.C. 20036.

21.0 Method Performance

Method performance was validated and performance specifications were developed using data from EPA's international inter-laboratory validation study (References 30-31) and the EPA/paper industry Long-Term Variability Study of discharges from the pulp and paper industry (58 FR 66078).

22.0 References

1. Tondeur, Yves. "Method 8290: Analytical Procedures and Quality Assurance for Multimedia Analysis of Polychlorinated Dibenzo-*p*-dioxins and Dibenzofurans by High Resolution Gas Chromatography/High Resolution Mass Spectrometry," USEPA EMSL, Las Vegas, Nevada, June 1987.
2. "Measurement of 2,3,7,8-Tetrachlorinated Dibenzo-*p*-dioxin (TCDD) and 2,3,7,8-Tetrachlorinated Dibenzofuran (TCDF) in Pulp, Sludges, Process Samples and Wastewaters from Pulp and Paper Mills," Wright State University, Dayton, OH 45435, June 1988.
3. "NCASI Procedures for the Preparation and Isomer Specific Analysis of Pulp and Paper Industry Samples for 2,3,7,8-TCDD and 2,3,7,8-TCDF," National Council of the Paper Industry for Air and Stream Improvement Inc., 260 Madison Avenue, New York, NY 10016, Technical Bulletin No. 551, Pre-Release Copy, July 1988.
4. "Analytical Procedures and Quality Assurance Plan for the Determination of PCDD/PCDF in Fish," USEPA, Environmental Research Laboratory, 6201 Congdon Boulevard, Duluth, MN 55804, April 1988.
5. Tondeur, Yves. "Proposed GC/MS Methodology for the Analysis of PCDDs and

- PCDFs in Special Analytical Services Samples," Triangle Laboratories, Inc., 801-10 Capitola Dr, Research Triangle Park, NC 27713, January 1988; updated by personal communication September 1988.
6. Lamparski, L.L. and Nestruck, T.J. "Determination of Tetra-, Hexa-, Hepta-, and Octachlorodibenzo-*p*-dioxin Isomers in Particulate Samples at Parts per Trillion Levels," *Analytical Chemistry*, 52: 2045-2054, 1980.
 7. Lamparski, L.L. and Nestruck, T.J. "Novel Extraction Device for the Determination of Chlorinated Dibenzodioxins (PCDDs) and Dibenzofurans (PCDFs) in Matrices Containing Water," *Chemosphere*, 19:27-31, 1989.
 8. Patterson, D.G., et. al. "Control of Interferences in the Analysis of Human Adipose Tissue for 2,3,7,8-Tetrachlorodibenzo-*p*-dioxin," *Environmental Toxicological Chemistry*, 5:355-360, 1986.
 9. Stanley, John S. and Sack, Thomas M. "Protocol for the Analysis of 2,3,7,8-Tetrachlorodibenzo-*p*-dioxin by High Resolution Gas Chromatography/High Resolution Mass Spectrometry," USEPA EMSL, Las Vegas, Nevada 89114, EPA 600/4-86-004, January 1986.
 10. "Working with Carcinogens," Department of Health, Education, & Welfare, Public Health Service, Centers for Disease Control, NIOSH, Publication 77-206, August 1977, NTIS PB-277256.
 11. "OSHA Safety and Health Standards, General Industry," OSHA 2206, 29 CFR 1910.
 12. "Safety in Academic Chemistry Laboratories," ACS Committee on Chemical Safety, 1979.
 13. "Standard Methods for the Examination of Water and Wastewater," 18th edition and later revisions, American Public Health Association, 1015 15th St, N.W., Washington, DC 20005, 1-35: Section 1090 (Safety), 1992.
 14. "Method 613-2,3,7,8-Tetrachlorodibenzo-*p*-dioxin," 40 CFR 136 (49 FR 43234), October 26, 1984, Section 4.1.
 15. Provost, L.P. and Elder, R.S. "Interpretation of Percent Recovery Data," *American Laboratory*, 15: 56-83, 1983.
 16. "Standard Practice for Sampling Water," ASTM Annual Book of Standards, ASTM, 1916 Race Street, Philadelphia, PA 19103-1187, 1980.
 17. "Methods 330.4 and 330.5 for Total Residual Chlorine," USEPA, EMSL, Cincinnati, OH 45268, EPA 600/4-79-020, March 1979.
 18. "Handbook of Analytical Quality Control in Water and Wastewater Laboratories," USEPA EMSL, Cincinnati, OH 45268, EPA-600/4-79-019, March 1979.
 19. Williams, Rick. Letter to Bill Telliard, June 4, 1993, available from the EPA Sample Control Center operated by DynCorp Viar, Inc., 300 N Lee St, Alexandria, VA 22314, 703-519-1140.
 20. Barkowski, Sarah. Fax to Sue Price, August 6, 1992, available from the EPA Sample Control Center operated by DynCorp Viar, Inc., 300 N Lee St, Alexandria VA 22314, 703-519-1140.
 21. "Analysis of Multi-media, Multi-concentration Samples for Dioxins and Furans, PCDD/PCDF Analyses Data Package", Narrative for Episode 4419, MRI Project No. 3091-A, op.cit. February 12, 1993, Available from the EPA Sample Control Center operated by DynCorp Viar Inc, 300 N Lee St, Alexandria, VA 22314 (703-519-1140).
 22. "Analytical Procedures and Quality Assurance Plan for the Determination of PCDD/PCDF in Fish", U.S. Environmental Protection Agency, Environmental Research Laboratory, Duluth, MN 55804, EPA/600/3-90/022, March 1990.
 23. Afghan, B.K., Carron, J., Goulden, P.D., Lawrence, J., Leger, D., Onuska, F., Sherry, J., and Wilkenson, R.J., "Recent Advances in Ultratrace Analysis of Dioxins and Related Halogenated Hydrocarbons", *Can J. Chem.*, 65: 1086-1097, 1987.
 24. Sherry, J.P. and Tse, H. "A Procedure for the Determination of Polychlorinated Dibenzodioxins in Fish", *Chemosphere*, 20: 865-872, 1990.
 25. "Preliminary Fish Tissue Study", Results of Episode 4419, available from the EPA Sample Control Center operated by DynCorp Viar, Inc., 300 N Lee St, Alexandria, VA 22314, 703-519-1140.
 26. Nestruck, Terry L. DOW Chemical Co., personal communication with D.R. Rushneck, April 8, 1993. Details available from the U.S. Environmental Protection Agency Sample Control Center operated by DynCorp Viar Inc, 300 N Lee St, Alexandria, VA 22314, 703-519-1140.
 27. Barnstadt, Michael. "Big Fish Column", Triangle Laboratories of RTP, Inc., SOP 129-90, 27 March 27, 1992.
 28. "Determination of Polychlorinated Dibenzodioxins (PCDD) and Dibenzofurans (PCDF) in Environmental Samples Using EPA Method 1613", Chemical Sciences Department, Midwest Research Institute, 425 Volker Boulevard, Kansas City, MO 44110-2299, Standard Operating Procedure No. CS-153, January 15, 1992.
 29. Ryan, John J. Raymonde Lizotte and William H. Newsome, J. *Chromatog.* 303 (1984) 351-360.
 30. Telliard, William A., McCarty, Harry B., and Riddick, Lynn S. "Results of the Interlaboratory Validation Study of USEPA Method 1613 for the Analysis of Tetra-through Octachlorinated Dioxins and Furans by Isotope Dilution GC/MS," *Chemosphere*, 27, 41-46 (1993).
 31. "Results of the International Interlaboratory Validation Study of USEPA Method 1613", October 1994, available from the EPA Sample Control Center operated by DynCorp

Viar, Inc., 300 N Lee St, Alexandria, VA
22314, 703-519-1140.

23.0 Tables and Figures

TABLE 1—CHLORINATED DIBENZO-P-DIOXINS AND FURANS DETERMINED BY ISOTOPE DILUTION AND INTERNAL STANDARD HIGH RESOLUTION GAS CHROMATOGRAPHY (HRGC)/HIGH RESOLUTION MASS SPECTROMETRY (HRMS)

| CDDs/CDFs ¹ | CAS registry | Labeled analog | CAS registry |
|------------------------|--------------|--|--------------|
| 2,3,7,8-TCDD | 1746-01-6 | ¹³ C ₁₂ -2,3,7,8-TCDD | 76523-40-5 |
| Total TCDD | 41903-57-5 | ³⁷ Cl ₄ -2,3,7,8-TCDD | 85508-50-5 |
| 2,3,7,8-TCDF | 51207-31-9 | ¹³ C ₁₂ -2,3,7,8-TCDF | 89059-46-1 |
| Total-TCDF | 55722-27-5 | | |
| 1,2,3,7,8-PeCDD | 40321-76-4 | ¹³ C ₁₂ -1,2,3,7,8-PeCDD | 109719-79-1 |
| Total-PeCDD | 36088-22-9 | | |
| 1,2,3,7,8-PeCDF | 57117-41-6 | ¹³ C ₁₂ -1,2,3,7,8-PeCDF | 109719-77-9 |
| 2,3,4,7,8-PeCDF | 57117-31-4 | ¹³ C ₁₂ -2,3,4,7,8-PeCDF | 116843-02-8 |
| Total-PeCDF | 30402-15-4 | | |
| 1,2,3,4,7,8-HxCDD | 39227-28-6 | ¹³ C ₁₂ -1,2,3,4,7,8-HxCDD | 109719-80-4 |
| 1,2,3,6,7,8-HxCDD | 57653-85-7 | ¹³ C ₁₂ -1,2,3,6,7,8-HxCDD | 109719-81-5 |
| 1,2,3,7,8,9-HxCDD | 19408-74-3 | ¹³ C ₁₂ -1,2,3,7,8,9-HxCDD | 109719-82-6 |
| Total-HxCDD | 34465-46-8 | | |
| 1,2,3,4,7,8-HxCDF | 70648-26-9 | ¹³ C ₁₂ -1,2,3,4,7,8-HxCDF | 114423-98-2 |
| 1,2,3,6,7,8-HxCDF | 57117-44-9 | ¹³ C ₁₂ -1,2,3,6,7,8-HxCDF | 116843-03-9 |
| 1,2,3,7,8,9-HxCDF | 72918-21-9 | ¹³ C ₁₂ -1,2,3,7,8,9-HxCDF | 116843-04-0 |
| 2,3,4,6,7,8-HxCDF | 60851-34-5 | ¹³ C ₁₂ -2,3,4,6,7,8-HxCDF | 116843-05-1 |
| Total-HxCDF | 55684-94-1 | | |
| 1,2,3,4,6,7,8-HpCDD | 35822-46-9 | ¹³ C ₁₂ -1,2,3,4,6,7,8-HpCDD | 109719-83-7 |
| Total-HpCDD | 37871-00-4 | | |
| 1,2,3,4,6,7,8-HpCDF | 67562-39-4 | ¹³ C ₁₂ -1,2,3,4,6,7,8-HpCDF | 109719-84-8 |
| 1,2,3,4,7,8,9-HpCDF | 55673-89-7 | ¹³ C ₁₂ -1,2,3,4,7,8,9-HpCDF | 109719-94-0 |
| Total-HpCDF | 38998-75-3 | | |
| OCDD | 3268-87-9 | ¹³ C ₁₂ -OCDD | 114423-97-1 |
| OCDF | 39001-02-0 | Not used. | |

¹ Chlorinated dibenzo-p-dioxins and chlorinated dibenzofurans.
TCDD = Tetrachlorodibenzo-p-dioxin.
TCDF = Tetrachlorodibenzofuran.
PeCDD = Pentachlorodibenzo-p-dioxin.
PeCDF = Pentachlorodibenzofuran.
HxCDD = Hexachlorodibenzo-p-dioxin.
HxCDF = Hexachlorodibenzofuran.
HpCDD = Heptachlorodibenzo-p-dioxin.
HpCDF = Heptachlorodibenzofuran.
OCDD = Octachlorodibenzo-p-dioxin.
OCDF = Octachlorodibenzofuran.

TABLE 2—RETENTION TIME REFERENCES, QUANTITATION REFERENCES, RELATIVE RETENTION TIMES, AND MINIMUM LEVELS FOR CDDS AND DCFS

| CDD/CDF | Retention time and quantitation reference | Relative retention time | Minimum level ¹ | | |
|---|--|-------------------------|----------------------------|--------------------|----------------------|
| | | | Water (pg/L; ppq) | Solid (ng/kg; ppt) | Extract (pg/μL; ppb) |
| Compounds using ¹³C₁₂-1,2,3,4-TCDD as the Injection Internal Standard | | | | | |
| 2,3,7,8-TCDF | ¹³ C ₁₂ -2,3,7,8-TCDF | 0.999-1.003 | 10 | 1 | 0.5 |
| 2,3,7,8-TCDD | ¹³ C ₁₂ -2,3,7,8-TCDD | 0.999-1.002 | 10 | 1 | 0.5 |
| 1,2,3,7,8-Pe | ¹³ C ₁₂ -1,2,3,7,8-PeCDF | 0.999-1.002 | 50 | 5 | 2.5 |
| 2,3,4,7,8-PeCDF | ¹³ C ₁₂ -2,3,4,7,8-PeCDF | 0.999-1.002 | 50 | 5 | 2.5 |
| 1,2,3,7,8-PeCDD | ¹³ C ₁₂ -1,2,3,7,8-PeCDD | 0.999-1.002 | 50 | 5 | 2.5 |
| ¹³ C ₁₂ -2,3,7,8-TCDF | ¹³ C ₁₂ -1,2,3,4-TCDD | 0.923-1.103 | | | |
| ¹³ C ₁₂ -2,3,7,8-TCDD | ¹³ C ₁₂ -1,2,3,4-TCDD | 0.976-1.043 | | | |
| ¹³ C ₁₂ -2,3,7,8-TCDD | ¹³ C ₁₂ -1,2,3,4-TCDD | 0.989-1.052 | | | |
| ¹³ C ₁₂ -1,2,3,7,8-PeCDF | ¹³ C ₁₂ -1,2,3,4-TCDD | 1.000-1.425 | | | |
| ¹³ C ₁₂ -2,3,4,7,8-PeCDF | ¹³ C ₁₂ -1,2,3,4-TCDD | 1.001-1.526 | | | |
| ¹³ C ₁₂ -1,2,3,7,8-PeCDF | ¹³ C ₁₂ -1,2,3,4-TCDD | 1.000-1.567 | | | |
| Compounds using ¹³C₁₂-1,2,3,7,8,9-HxCDD as the Injection Internal Standard | | | | | |
| 1,2,3,4,7,8-HxCDF | ¹³ C ₁₂ -1,2,3,4,7,8-HxCDF | 0.999-1.001 | 50 | 5 | 2.5 |
| 1,2,3,6,7,8-HxCDF | ¹³ C ₁₂ -1,2,3,6,7,8-HxCDF | 0.997-1.005 | 50 | 5 | 2.5 |
| 1,2,3,7,8,9-HxCDF | ¹³ C ₁₂ -1,2,3,7,8,9-HxCDF | 0.999-1.001 | 50 | 5 | 2.5 |
| 2,3,4,6,7,8-HxCDF | ¹³ C ₁₂ -2,3,4,6,7,8-HxCDF | 0.999-1.001 | 50 | 5 | 2.5 |
| 1,2,3,4,7,8-HxCDD | ¹³ C ₁₂ -1,2,3,4,7,8-HxCDD | 0.999-1.001 | 50 | 5 | 2.5 |

TABLE 2—RETENTION TIME REFERENCES, QUANTITATION REFERENCES, RELATIVE RETENTION TIMES, AND MINIMUM LEVELS FOR CDDS AND DCFS—Continued

| CDD/CDF | Retention time and quantitation reference | Relative retention time | Minimum level ¹ | | |
|--|--|-------------------------|----------------------------|--------------------|----------------------|
| | | | Water (pg/L; ppq) | Solid (ng/kg; ppt) | Extract (pg/μL; ppb) |
| 1,2,3,6,7,8-HxCDD | ¹³ C ₁₂ -1,2,3,6,7,8-HxCDD | 0.998–1.004 | 50 | 5 | 2.5 |
| 1,2,3,7,8,9-HxCDD | (²) | 1.000–1.019 | 50 | 5 | 2.5 |
| 1,2,3,4,6,7,8-HpCDF | ¹³ C ₁₂ -1,2,3,4,6,7,8-HpCDF | 0.999–1.001 | 50 | 5 | 2.5 |
| 1,2,3,4,7,8,9-HpCDF | ¹³ C ₁₂ -1,2,3,4,7,8,9-HpCDF | 0.999–1.001 | 50 | 5 | 2.5 |
| 1,2,3,4,6,7,8-HpCDD | ¹³ C ₁₂ -1,2,3,4,6,7,8-HpCDD | 0.999–1.001 | 50 | 5 | 2.5 |
| OCDF | ¹³ C ₁₂ -OCDD | 0.999–1.001 | 100 | 10 | 5.0 |
| OCDD | ¹³ C ₁₂ -OCDD | 0.999–1.001 | 100 | 10 | 5.0 |
| 1,2,3,4,6,7,8,-HxCDF | ¹³ C ₁₂ -1,2,3,7,8,9-HpCDD | 0.949–0.975 | | | |
| ¹³ C ₁₂ -1,2,3,7,8,9-HxCDF | ¹³ C ₁₂ -1,2,3,7,8,9-HpCDD | 0.977–1.047 | | | |
| ¹³ C ₁₂ -2,3,4,6,7,8,-HxCDF | ¹³ C ₁₂ -1,2,3,7,8,9-HpCDD | 0.959–1.021 | | | |
| ¹³ C ₁₂ -1,2,3,4,7,8,-HxCDF | ¹³ C ₁₂ -1,2,3,7,8,9-HpCDD | 0.977–1.000 | | | |
| ¹³ C ₁₂ -1,2,3,6,7,8,-HxCDF | ¹³ C ₁₂ -1,2,3,7,8,9-HpCDD | 0.981–1.003 | | | |
| ¹³ C ₁₂ -1,2,3,4,6,7,8-HxCDF | ¹³ C ₁₂ -1,2,3,7,8,9-HpCDD | 1.043–1.085 | | | |
| ¹³ C ₁₂ -1,2,3,4,7,8,9-HxCDF | ¹³ C ₁₂ -1,2,3,7,8,9-HpCDD | 1.057–1.151 | | | |
| ¹³ C ₁₂ -1,2,3,4,6,7,8-HxCDF | ¹³ C ₁₂ -1,2,3,7,8,9-HpCDD | 1.086–1.110 | | | |
| ¹³ C ₁₂ OCDD | ¹³ C ₁₂ -1,2,3,7,8,9-HpCDD | 1.032–1.311 | | | |

¹The Minimum Level (ML) for each analyte is defined as the level at which the entire analytical system must give a recognizable signal and acceptable calibration point. It is equivalent to the concentration of the lowest calibration standard, assuming that all method-specified sample weights, volumes, and cleanup procedures have been employed.

²The retention time reference for 1,2,3,7,8,9-HxCDD is ¹³C₁₂-1,2,3,6,7,8-HxCDD, and 1,2,3,7,8,9-HxCDD is quantified using the averaged responses for ¹³C₁₂-1,2,3,4,7,8-HxCDD and ¹³C₁₂-1,2,3,6,7,8-HxCDD.

TABLE 3—CONCENTRATION OF STOCK AND SPIKING SOLUTIONS CONTAINING CDDS/CDFS AND LABELED COMPOUNDS

| CDD/CDF | Labeled compound stock solution ¹ (ng/mL) | Labeled compound spiking solution ² (ng/mL) | PAR stock solution ³ (ng/mL) | PAR spiking solution ⁴ (ng/mL) |
|--|--|--|---|---|
| 2,3,7,8-TCDD | | | 40 | 0.8 |
| 2,3,7,8-TCDF | | | 40 | 0.8 |
| 1,2,3,7,8-PeCDD | | | 200 | 4 |
| 1,2,3,7,8-PeCDF | | | 200 | 4 |
| 2,3,4,7,8-PeCDF | | | 200 | 4 |
| 1,2,3,4,7,8-HxCDD | | | 200 | 4 |
| 1,2,3,6,7,8-HxCDD | | | 200 | 4 |
| 1,2,3,7,8,9-HxCDD | | | 200 | 4 |
| 1,2,3,4,7,8-HxCDF | | | 200 | 4 |
| 1,2,3,6,7,8-HxCDF | | | 200 | 4 |
| 1,2,3,7,8,9-HxCDF | | | 200 | 4 |
| 2,3,4,6,7,8-HxCDF | | | 200 | 4 |
| 1,2,3,4,6,7,8-HpCDD | | | 200 | 4 |
| 1,2,3,4,6,7,8-HpCDF | | | 200 | 4 |
| 1,2,3,4,7,8,9-HpCDF | | | 200 | 4 |
| OCDD | | | 400 | 8 |
| OCDF | | | 400 | 8 |
| ¹³ C ₁₂ -2,3,7,8-TCDD | 100 | 2 | | |
| ¹³ C ₁₂ -2,3,7,8-TCDF | 100 | 2 | | |
| ¹³ C ₁₂ -1,2,3,7,8-PeCDD | 100 | 2 | | |
| ¹³ C ₁₂ -1,2,3,7,8-PeCDF | 100 | 2 | | |
| ¹³ C ₁₂ -2,3,4,7,8-PeCDF | 100 | 2 | | |
| ¹³ C ₁₂ -1,2,3,4,7,8-HxCDD | 100 | 2 | | |
| ¹³ C ₁₂ -1,2,3,6,7,8-HxCDD | 100 | 2 | | |
| ¹³ C ₁₂ -1,2,3,4,7,8-HxCDF | 100 | 2 | | |
| ¹³ C ₁₂ -1,2,3,6,7,8-HxCDF | 100 | 2 | | |
| ¹³ C ₁₂ -1,2,3,7,8,9-HxCDF | 100 | 2 | | |
| ¹³ C ₁₂ -2,3,4,6,7,8-HxCDF | 100 | 2 | | |
| ¹³ C ₁₂ -1,2,3,4,6,7,8-HpCDD | 100 | 2 | | |
| ¹³ C ₁₂ -1,2,3,4,6,7,8-HpCDF | 100 | 2 | | |
| ¹³ C ₁₂ -1,2,3,4,7,8,9-HpCDF | 100 | 2 | | |
| ¹³ C ₁₂ -OCDD | 200 | 4 | | |
| Cleanup Standard ⁵ | | | | |
| ³⁷ Cl ₁ -2,3,7,8-TCDD | 0.8 | | | |
| Internal Standards ⁶ | | | | |
| ¹³ C ₁₂ -1,2,3,4-TCDD | 200 | | | |

TABLE 3—CONCENTRATION OF STOCK AND SPIKING SOLUTIONS CONTAINING CDDS/CDFS AND LABELED COMPOUNDS—Continued

| CDD/CDF | Labeled compound stock solution ¹ (ng/mL) | Labeled compound spiking solution ² (ng/mL) | PAR stock solution ³ (ng/mL) | PAR spiking solution ⁴ (ng/mL) |
|--|--|--|---|---|
| ¹³ C ₁₂ -1,2,3,7,8,9-HxCDD | 200 | | | |

¹ Section 7.10—prepared in nonane and diluted to prepare spiking solution.
² Section 7.10.3—prepared in acetone from stock solution daily.
³ Section 7.9—prepared in nonane and diluted to prepare spiking solution.
⁴ Section 7.14—prepared in acetone from stock solution daily.
⁵ Section 7.11—prepared in nonane and added to extract prior to cleanup.
⁶ Section 7.12—prepared in nonane and added to the concentrated extract immediately prior to injection into the GC (Section 14.2).

TABLE 4—CONCENTRATION OF CDDS/CDFS IN CALIBRATION AND CALIBRATION VERIFICATION SOLUTIONS¹ (SECTION 15.3)

| | CDD/CDF | CS2 (ng/mL) | CS3 (ng/mL) | CS4 (ng/mL) | CS5 (ng/mL) |
|--|---------|-------------|-------------|-------------|-------------|
| 2,3,7,8-TCDD | 0.5 | 2 | 10 | 40 | 200 |
| 2,3,7,8-TCDF | 0.5 | 2 | 10 | 40 | 200 |
| 1,2,3,7,8-PeCDD | 2.5 | 10 | 50 | 200 | 1000 |
| 1,2,3,7,8-PeCDF | 2.5 | 10 | 50 | 200 | 1000 |
| 2,3,4,7,8-PeCDF | 2.5 | 10 | 50 | 200 | 1000 |
| 1,2,3,4,7,8-HxCDD | 2.5 | 10 | 50 | 200 | 1000 |
| 1,2,3,6,7,8-HxCDD | 2.5 | 10 | 50 | 200 | 1000 |
| 1,2,3,7,8,9-HxCDD | 2.5 | 10 | 50 | 200 | 1000 |
| 1,2,3,4,7,8-HxCDF | 2.5 | 10 | 50 | 200 | 1000 |
| 1,2,3,6,7,8-HxCDF | 2.5 | 10 | 50 | 200 | 1000 |
| 1,2,3,7,8,9-HxCDF | 2.5 | 10 | 50 | 200 | 1000 |
| 2,3,4,6,7,8-HxCDF | 2.5 | 10 | 50 | 200 | 1000 |
| 1,2,3,4,6,7,8-HpCDD | 2.5 | 10 | 50 | 200 | 1000 |
| 1,2,3,4,6,7,8-HpCDF | 2.5 | 10 | 50 | 200 | 1000 |
| 1,2,3,4,7,8,9-HpCDF | 2.5 | 10 | 50 | 200 | 1000 |
| OCDD | 5.0 | 20 | 100 | 400 | 2000 |
| OCDF | 5.0 | 20 | 100 | 400 | 2000 |
| ¹³ C ₁₂ -2,3,7,8-TCDD | 100 | 100 | 100 | 100 | 100 |
| ¹³ C ₁₂ -2,3,7,8-TCDF | 100 | 100 | 100 | 100 | 100 |
| ¹³ C ₁₂ -1,2,3,7,8-PeCDD | 100 | 100 | 100 | 100 | 100 |
| ¹³ C ₁₂ -PeCDF | 100 | 100 | 100 | 100 | 100 |
| ¹³ C ₁₂ -2,3,4,7,8-PeCDF | 100 | 100 | 100 | 100 | 100 |
| ¹³ C ₁₂ -1,2,3,4,7,8-HxCDD | 100 | 100 | 100 | 100 | 100 |
| ¹³ C ₁₂ -1,2,3,6,7,8-HxCDD | 100 | 100 | 100 | 100 | 100 |
| ¹³ C ₁₂ -1,2,3,4,7,8-HxCDF | 100 | 100 | 100 | 100 | 100 |
| ¹³ C ₁₂ -1,2,3,6,7,8-HxCDF | 100 | 100 | 100 | 100 | 100 |
| ¹³ C ₁₂ -1,2,3,7,8,9-HxCDF | 100 | 100 | 100 | 100 | 100 |
| ¹³ C ₁₂ -1,2,3,4,6,7,8-HpCDD | 100 | 100 | 100 | 100 | 100 |
| ¹³ C ₁₂ -1,2,3,4,6,7,8-HpCDF | 100 | 100 | 100 | 100 | 100 |
| ¹³ C ₁₂ -1,2,3,4,7,8,9-HpCDF | 100 | 100 | 100 | 100 | 100 |
| ¹³ C ₁₂ -OCDD | 200 | 200 | 200 | 200 | 200 |
| Cleanup Standard: ³⁷ C ₁₄ -2,3,7,8-TCDD | 0.5 | 2 | 10 | 40 | 200 |
| Internal Standards: ¹³ C ₁₂ -1,2,3,4-TCDD | 100 | 100 | 100 | 100 | 100 |
| ¹³ C ₁₂ -1,2,3,7,8,9-HxCDD | 100 | 100 | 100 | 100 | 100 |

TABLE 5—GC RETENTION TIME WINDOW DEFINING SOLUTION AND ISOMER SPECIFICITY TEST STANDARD (SECTION 7.15)

| DB-5 column GC retention-time window defining solution | | |
|--|----------------------|----------------|
| CDD/CDF | First eluted | Last eluted |
| TCDF | 1,3,6,8- | 1,2,8,9- |
| TCDD | 1,3,6,8- | 1,2,8,9- |
| PeCDF | 1,3,4,6,8- | 1,2,3,8,9- |
| PeCDD | 1,2,4,7,9- | 1,2,3,8,9- |
| HxCDF | 1,2,3,4,6,8- | 1,2,3,4,8,9- |
| HxCDD | 1,2,4,6,7,9- | 1,2,3,4,6,7- |
| HpCDF | 1,2,3,4,6,7,8- | 1,2,3,4,7,8,9- |

TABLE 5—GC RETENTION TIME WINDOW DEFINING SOLUTION AND ISOMER SPECIFICITY TEST STANDARD (SECTION 7.15)—Continued

| DB-5 column GC retention-time window defining solution | | |
|--|----------------|----------------|
| CDD/CDF | First eluted | Last eluted |
| HpCDD | 1,2,3,4,6,7,9- | 1,2,3,4,6,7,8- |

DB-5 Column TCDD Specificity Test Standard

1,2,3,7=1,2,3,8-TCDD
 2,3,7,8-TCDD
 1,2,3,9-TCDD

DB-225 Column TCDF Isomer Specificity Test Standard

2,3,4,7-TCDF
 2,3,7,8-TCDF
 1,2,3,9-TCDF

TABLE 6—ACCEPTANCE CRITERIA FOR PERFORMANCE TESTS WHEN ALL CDDS/CDFS ARE TESTED ¹

| CDD/CDF | Test conc. (ng/mL) | IPR ^{2,3} | | OPR (ng/mL) | VER (ng/mL) |
|--|--------------------|--------------------|-----------|-------------|-------------|
| | | s (ng/mL) | X (ng/mL) | | |
| 2,3,7,8-TCDD | 10 | 2.8 | 8.3–12.9 | 6.7–15.8 | 7.8–12.9 |
| 2,3,7,8-TCDF | 10 | 2.0 | 8.7–13.7 | 7.5–15.8 | 8.4–12.0 |
| 1,2,3,7,8-PeCDD | 50 | 7.5 | 38–66 | 35–71 | 39–65 |
| 1,2,3,7,8-PeCDF | 50 | 7.5 | 43–62 | 40–67 | 41–60 |
| 2,3,4,7,8-PeCDF | 50 | 8.6 | 36–75 | 34–80 | 41–61 |
| 1,2,3,4,7,8-HxCDD | 50 | 9.4 | 39–76 | 35–82 | 39–64 |
| 1,2,3,6,7,8-HxCDD | 50 | 7.7 | 42–62 | 38–67 | 39–64 |
| 1,2,3,7,8,9-HxCDD | 50 | 11.1 | 37–71 | 32–81 | 41–61 |
| 1,2,3,4,7,8-HxCDF | 50 | 8.7 | 41–59 | 36–67 | 45–56 |
| 1,2,3,6,7,8-HxCDF | 50 | 6.7 | 46–60 | 42–65 | 44–57 |
| 1,2,3,7,8,9-HxCDF | 50 | 6.4 | 42–61 | 39–65 | 45–56 |
| 2,3,4,6,7,8-HxCDF | 50 | 7.4 | 37–74 | 35–78 | 44–57 |
| 1,2,3,4,6,7,8-HpCDD | 50 | 7.7 | 38–65 | 35–70 | 43–58 |
| 1,2,3,4,6,7,8-HpCDF | 50 | 6.3 | 45–56 | 41–61 | 45–55 |
| 1,2,3,4,7,8,9-HpCDF | 50 | 8.1 | 43–63 | 39–69 | 43–58 |
| OCDD | 100 | 19 | 89–127 | 78–144 | 79–126 |
| OCDF | 100 | 27 | 74–146 | 63–170 | 63–159 |
| ¹³ C ₁₂ -2,3,7,8-TCDD | 100 | 37 | 28–134 | 20–175 | 82–121 |
| ¹³ C ₁₂ -2,3,7,8-TCDF | 100 | 35 | 31–113 | 22–152 | 71–140 |
| ¹³ C ₁₂ -1,2,3,7,8-PeCDD | 100 | 39 | 27–184 | 21–227 | 62–160 |
| ¹³ C ₁₂ -1,2,3,7,8-PeCDF | 100 | 34 | 27–156 | 21–192 | 76–130 |
| ¹³ C ₁₂ -2,3,4,7,8-PeCDF | 100 | 38 | 16–279 | 13–328 | 77–130 |
| ¹³ C ₁₂ -1,2,3,4,7,8-HxCDD | 100 | 41 | 29–147 | 21–193 | 85–117 |
| ¹³ C ₁₂ -1,2,3,6,7,8-HxCDD | 100 | 38 | 34–122 | 25–163 | 85–118 |
| ¹³ C ₁₂ -1,2,3,4,7,8-HxCDF | 100 | 43 | 27–152 | 19–202 | 76–131 |
| ¹³ C ₁₂ -1,2,3,6,7,8-HxCDF | 100 | 35 | 30–122 | 21–159 | 70–143 |
| ¹³ C ₁₂ -1,2,3,7,8,9-HxCDF | 100 | 40 | 24–157 | 17–205 | 74–135 |
| ¹³ C ₁₂ -2,3,4,6,7,8-HxCDF | 100 | 37 | 29–136 | 22–176 | 73–137 |
| ¹³ C ₁₂ -1,2,3,4,6,7,8-HpCDD | 100 | 35 | 34–129 | 26–166 | 72–138 |
| ¹³ C ₁₂ -1,2,3,4,6,7,8-HpCDF | 100 | 41 | 32–110 | 21–158 | 78–129 |
| ¹³ C ₁₂ -1,2,3,4,7,8,9-HpCDF | 100 | 40 | 28–141 | 20–186 | 77–129 |
| ¹³ C ₁₂ -OCDD | 200 | 95 | 41–276 | 26–397 | 96–415 |
| ³⁷ Cl ₄ -2,3,7,8-TCDD | 10 | 3.6 | 3.9–15.4 | 3.1–19.1 | 7.9–12.7 |

¹ All specifications are given as concentration in the final extract, assuming a 20 µL volume.
² s = standard deviation of the concentration.
³ X = average concentration.

TABLE 6A—ACCEPTANCE CRITERIA FOR PERFORMANCE TESTS WHEN ONLY TETRA COMPOUNDS ARE TESTED ¹

| CDD/CDF | Test Conc. (ng/mL) | IPR ^{2,3} | | OPR (ng/mL) | VER (ng/mL) |
|---|--------------------|--------------------|-----------|-------------|-------------|
| | | s (ng/mL) | X (ng/mL) | | |
| 2,3,7,8-TCDD | 10 | 2.7 | 8.7–12.4 | 7.314.6 | 8.2–12.3 |
| 2,3,7,8-TCDF | 10 | 2.0 | 9.1–13.1 | 8.0–14.7 | 8.6–11.6 |
| ¹³ C ₁₂ -2,3,7,8-TCDD | 100 | 35 | 32–115 | 25–141 | 85–117 |
| ¹³ C ₁₂ -2,3,7,8-TCDF | 100 | 34 | 35–99 | 26–126 | 76–131 |

TABLE 6A—ACCEPTANCE CRITERIA FOR PERFORMANCE TESTS WHEN ONLY TETRA COMPOUNDS ARE TESTED¹—Continued

| CDD/CDF | Test Conc. (ng/mL) | IPR ^{2,3} | | OPR (ng/mL) | VER (ng/mL) |
|---|--------------------|--------------------|-----------|-------------|-------------|
| | | s (ng/mL) | X (ng/mL) | | |
| ³⁷ Cl ₄ -2,3,7,8-TCDD | 10 | 3.4 | 4.5–13.4 | 3.7–15.8 | 8.3–12.1 |

¹ All specifications are given as concentration in the final extract, assuming a 20 µL volume.
² s = standard deviation of the concentration.
³ X = average concentration.

TABLE 7—LABELED COMPOUNDS RECOVERY IN SAMPLES WHEN ALL CDDS/CDFS ARE TESTED

| Compound | Test conc. (ng/mL) | Labeled compound recovery | |
|--|--------------------|---------------------------|--------|
| | | (ng/mL) ¹ | (%) |
| ¹³ C ₁₂ -2,3,7,8-TCDD | 100 | 25–164 | 25–164 |
| ¹³ C ₁₂ -2,3,7,8-TCDF | 100 | 24–169 | 24–169 |
| ¹³ C ₁₂ -1,2,3,7,8-PeCDD | 100 | 25–181 | 25–181 |
| ¹³ C ₁₂ -1,2,3,7,8-PeCDF | 100 | 24–185 | 24–185 |
| ¹³ C ₁₂ -2,3,4,7,8-PeCDF | 100 | 21–178 | 21–178 |
| ¹³ C ₁₂ -1,2,3,4,7,8-HxCDD | 100 | 32–141 | 32–141 |
| ¹³ C ₁₂ -1,2,3,6,7,8-HxCDD | 100 | 28–130 | 28–130 |
| ¹³ C ₁₂ -1,2,3,4,7,8-HxCDF | 100 | 26–152 | 26–152 |
| ¹³ C ₁₂ -1,2,3,6,7,8-HxCDF | 100 | 26–123 | 26–123 |
| ¹³ C ₁₂ -1,2,3,7,8,9-HxCDF | 100 | 29–147 | 29–147 |
| ¹³ C ₁₂ -2,3,4,6,7,8-HxCDF | 100 | 28–136 | 28–136 |
| ¹³ C ₁₂ -1,2,3,4,6,7,8-HpCDD | 100 | 23–140 | 23–140 |
| ¹³ C ₁₂ -1,2,3,4,6,7,8-HpCDF | 100 | 28–143 | 28–143 |
| ¹³ C ₁₂ -1,2,3,4,7,8,9-HpCDF | 100 | 26–138 | 26–138 |
| ¹³ C ₁₂ -OCDD | 200 | 34–313 | 17–157 |
| ³⁷ Cl ₄ -2,3,7,8-TCDD | 10 | 3.5–19.7 | 35–197 |

¹ Specification given as concentration in the final extract, assuming a 20-µL volume.

TABLE 7A—LABELED COMPOUND RECOVERY IN SAMPLES WHEN ONLY TETRA COMPOUNDS ARE TESTED

| Compound | Test conc. (ng/mL) | Labeled compound recovery | |
|---|--------------------|---------------------------|--------|
| | | (ng/mL) ¹ | (%) |
| ¹³ C ₁₂ -2,3,7,8-TCDD | 100 | 31–137 | 31–137 |
| ¹³ C ₁₂ -2,3,7,8-TCDF | 100 | 29–140 | 29–140 |
| ³⁷ Cl ₄ -2,3,7,8-TCDD | 10 | 4.2–16.4 | 42–164 |

¹ Specification given as concentration in the final extract, assuming a 20 µL volume.

TABLE 8—DESCRIPTORS, EXACT M/Z'S, M/Z TYPES, AND ELEMENTAL COMPOSITIONS OF THE CDDS AND CDFS

| Descriptor | Exact M/Z ¹ | M/Z type | Elemental composition | Substance ² | |
|------------|------------------------|----------|---|--|--------------------|
| 1 | 292.9825 | Lock | C ₇ F ₁₁ | PFK | |
| | 303.9016 | M | C ₁₂ H ₄ ³⁵ Cl ₄ O | TCDF | |
| | 305.8987 | M=2 | C ₁₂ H ₄ ³⁵ Cl ₃ ³⁷ ClO | TCDF | |
| | 315.9419 | M | ¹³ C ₁₂ H ₄ ³⁵ Cl ₄ O | TCDF ³ | |
| | 317.9389 | M=2 | ¹³ C ₁₂ H ₄ ³⁵ Cl ₃ ³⁷ ClO | TCDF ³ | |
| | 319.8965 | M | C ₁₂ H ₄ ³⁵ Cl ₄ O ₂ | TCDD | |
| | 321.8936 | M=2 | C ₁₂ H ₄ ³⁵ Cl ₃ ³⁷ ClO ₂ | TCDD | |
| | 327.8847 | M | C ₁₂ H ₄ ³⁷ Cl ₄ O ₂ | TCDD ⁴ | |
| | 330.9792 | QC | C ₇ F ₁₃ | PFK | |
| | 331.9368 | M | ¹³ C ₁₂ H ₄ ³⁵ Cl ₄ O ₂ | TCDD ³ | |
| | 333.9339 | M=2 | ¹³ C ₁₂ H ₄ ³⁵ Cl ₃ ³⁷ ClO ₂ | TCDD ³ | |
| | 375.8364 | M=2 | C ₁₂ H ₄ ³⁵ Cl ₅ ³⁷ ClO | HxCDFE | |
| | 2 | 339.8597 | M=2 | C ₁₂ H ₃ ³⁵ Cl ₄ ³⁷ ClO | PeCDF |
| | | 341.8567 | M=4 | C ₁₂ H ₃ ³⁵ Cl ₃ ³⁷ Cl ₂ O | PeCDF |
| | | 351.9000 | M=2 | ¹³ C ₁₂ H ₃ ³⁵ Cl ₄ ³⁷ ClO | PeCDF |
| | | 353.8970 | M=4 | ¹³ C ₁₂ H ₃ ³⁵ Cl ₃ ³⁷ Cl ₂ O | PeCDF ³ |
| | | 354.9792 | Lock | C ₆ F ₁₃ | PFK |
| 355.8546 | | M=2 | C ₁₂ H ₃ ³⁵ Cl ₄ ³⁷ ClO ₂ | PeCDD | |
| 357.8516 | | M=4 | C ₁₂ H ₃ ³⁵ Cl ₃ ³⁷ Cl ₂ O ₂ | PeCDD | |

TABLE 8—DESCRIPTORS, EXACT M/Z'S, M/Z TYPES, AND ELEMENTAL COMPOSITIONS OF THE CDDs AND CDFs—Continued

| Descriptor | Exact M/Z ¹ | M/Z type | Elemental composition | Substance ² |
|------------|------------------------|----------|---|---|
| 3 | 367.8949 | M=2 | ¹³ C ₁₂ H ₃ ³⁵ Cl ₄ ³⁷ ClO ₂ | PeCDD ³ |
| | 369.8919 | M=4 | ¹³ C ₁₂ H ₃ ³⁵ Cl ₃ ³⁷ Cl ₂ O ₂ | PeCDD ³ |
| | 409.7974 | M=2 | C ₁₂ H ₃ ³⁵ Cl ₆ ³⁷ ClO | HpCDPE |
| | 373.8208 | M=2 | C ₁₂ H ₂ ³⁵ Cl ₅ ³⁷ ClO | HxCDF |
| | 375.8178 | M=4 | C ₁₂ H ₂ ³⁵ Cl ₄ ³⁷ Cl ₂ O | HxCDF |
| | 383.8639 | M | ¹³ C ₁₂ H ₂ ³⁵ Cl ₆ O | HxCDF ³ |
| | 385.8610 | M=2 | ¹³ C ₁₂ H ₂ ³⁵ Cl ₅ ³⁷ ClO | HxCDF ³ |
| | 389.8157 | M=2 | C ₁₂ H ₂ ³⁵ Cl ₅ ³⁷ ClO ₂ | HxCDD |
| | 391.8127 | M=4 | C ₁₂ H ₂ ³⁵ Cl ₄ ³⁷ Cl ₂ O ₂ | HxCDD |
| | 392.9760 | Lock | C ₉ F ₁₅ | PFK |
| | 401.8559 | M=2 | ¹³ C ₁₂ H ₂ ³⁵ Cl ₅ ³⁷ ClO ₂ | HxCDD ³ |
| | 403.8529 | M=4 | ¹³ C ₁₂ H ₂ ³⁵ Cl ₄ ³⁷ Cl ₂ O ₂ | HxCDD ³ |
| 4 | 430.9729 | QC | C ₉ F ₁₇ | PFK |
| | 445.7555 | M=4 | C ₁₂ H ₂ ³⁵ Cl ₆ ³⁷ Cl ₂ O | OCDF |
| | 407.7818 | M=2 | C ₁₂ H ³⁵ Cl ₆ ³⁷ ClO | HpCDF |
| | 409.7789 | M=4 | C ₁₂ H ³⁵ Cl ₅ ³⁷ Cl ₂ O | HpCDF |
| | 417.8253 | M | ¹³ C ₁₂ H ³⁵ Cl ₇ O | HpCDF ³ |
| | 419.8220 | M=2 | ¹³ C ₁₂ H ³⁵ Cl ₆ ³⁷ ClO | HpCDF ³ |
| | 423.7766 | M=2 | C ₁₂ H ³⁵ Cl ₆ ³⁷ ClO ₂ | HpCDD |
| | 425.7737 | M=4 | C ₁₂ H ³⁵ Cl ₅ ³⁷ Cl ₂ O ₂ | HpCDD |
| | 430.9729 | Lock | C ₉ F ₁₇ | PFK |
| | 435.8169 | M=2 | ¹³ C ₁₂ H ³⁵ Cl ₆ ³⁷ ClO ₂ | HpCDD ³ |
| | 437.8140 | M=4 | ¹³ C ₁₂ H ³⁵ Cl ₅ ³⁷ Cl ₂ O ₂ | HpCDD ³ |
| | 5 | 479.7165 | M=4 | C ₁₂ H ³⁵ Cl ₇ ³⁷ Cl ₂ O |
| 441.7428 | | M=2 | C ₁₂ ³⁵ Cl ₇ ³⁷ ClO | OCDF |
| 442.9728 | | Lock | C ₁₀ F ₁₇ | PFK |
| 443.7399 | | M=4 | C ₁₂ ³⁵ Cl ₆ ³⁷ Cl ₂ O | OCDF |
| 457.7377 | | M=2 | C ₁₂ ³⁵ Cl ₇ ³⁷ ClO ₂ | OCDD |
| 459.7348 | | M=4 | C ₁₂ ³⁵ Cl ₆ ³⁷ Cl ₂ O ₂ | OCDD |
| 469.7779 | | M=2 | ¹³ C ₁₂ ³⁵ Cl ₇ ³⁷ ClO ₂ | OCDD ³ |
| 471.7750 | | M=4 | ¹³ C ₁₂ ³⁵ Cl ₆ ³⁷ Cl ₂ O ₂ | OCDD ³ |
| 513.6775 | | M=4 | C ₁₂ ³⁵ Cl ₈ ³⁷ Cl ₂ O | DCDPE |

¹ Nuclidic masses used:

- H = 1.007825.
- O = 15.994915.
- C = 12.00000.
- ³⁵Cl = 34.968853.
- ¹³C = 13.003355.
- ³⁷Cl = 36.965903.
- F = 18.9984.

- ² TCDD = Tetrachlorodibenzo-p-dioxin.
- PeCDD = Pentachlorodibenzo-p-dioxin.
- HxCDD = Hexachlorodibenzo-p-dioxin.
- HpCDD = Heptachlorodibenzo-p-dioxin.
- OCDD = Octachlorodibenzo-p-dioxin.
- HxCDF = Hexachlorodiphenyl ether.
- OCDF = Octachlorodiphenyl ether.
- DCDPE = Decachlorodiphenyl ether.
- TCDF = Tetrachlorodibenzofuran.
- PeCDF = Pentachlorodibenzofuran.
- HxCDF = Hexachlorodibenzofuran.
- HpCDF = Heptachlorodibenzofuran.
- OCDF = Octachlorodibenzofuran.
- HpCDPE = Heptachlorodiphenyl ether.
- NCDPE = Nonachlorodiphenyl ether.
- PFK = Perfluorokerosene.

³ Labeled compound.

⁴ There is only one m/z for ³⁷Cl₄-2,3,7,8,-TCDD (cleanup standard).

TABLE 9—THEORETICAL ION ABUNDANCE RATIOS AND QC LIMITS

| Number of chlorine atoms | M/Z's forming ratio | Theoretical ratio | QC limit ¹ | |
|--------------------------|---------------------|-------------------|-----------------------|-------|
| | | | Lower | Upper |
| 4 ² | M/(M=2) | 0.77 | 0.65 | 0.89 |
| 5 | (M=2)/(M=4) | 1.55 | 1.32 | 1.78 |
| 6 | (M=2)/(M=4) | 1.24 | 1.05 | 1.43 |
| 6 ³ | M/(M=2) | 0.51 | 0.43 | 0.59 |
| 7 | (M=2)/(M=4) | 1.05 | 0.88 | 1.20 |
| 7 ⁴ | M/(M=2) | 0.44 | 0.37 | 0.51 |
| 8 | (M=2)/(M=4) | 0.89 | 0.76 | 1.02 |

¹ QC limits represent ±15% windows around the theoretical ion abundance ratios.

² Does not apply to ³⁷Cl₄-2,3,7,8-TCDD (cleanup standard).

³ Used for ¹³C₁₂-HxCDF only.

⁴ Used for ¹³C₁₂-HpCDF only.

TABLE 10—SUGGESTED SAMPLE QUANTITIES TO BE EXTRACTED FOR VARIOUS MATRICES ¹

| Sample Matrix ² | Example | Percent solids | Phase | Quantity extracted |
|----------------------------|----------------------------|----------------|-------------------------|--------------------|
| Single-phase: | | | | |
| Aqueous | Drinking water | <1 | (³) | 1000 mL. |
| | Groundwater | | | |
| | Treated wastewater | | | |
| Solid | Dry soil | >20 | Solid | 10 g. |
| | Compost | | | |
| | Ash | | | |
| Organic | Waste solvent | <1 | Organic | 10 g. |
| | Waste oil | | | |
| | Organic polymer | | | |
| Tissue | Fish | | Organic | 10 g. |
| | Human adipose | | | |
| Multi-phase: | | | | |
| Liquid/Solid: | | | | |
| Aqueous/Solid | Wet soil | 1-30 | Solid | 10 g. |
| | Untreated effluent. | | | |
| | Digested municipal sludge. | | | |
| | Filter cake. | | | |
| | Paper pulp. | | | |
| Organic/solid | Industrial sludge | 1-100 | Both | 10 g. |
| | Oily waste | | | |
| Liquid/Liquid: | | | | |
| Aqueous/organic | In-process effluent | <1 | Organic | 10 g. |
| | Untreated effluent | | | |
| | Drum waste | | | |
| Aqueous/organic/ solid. | Untreated effluent | >1 | Organic and solid | 10 g. |
| | Drum waste | | | |

¹ The quantity of sample to be extracted is adjusted to provide 10 g of solids (dry weight). One liter of aqueous samples containing 1% solids will contain 10 g of solids. For aqueous samples containing greater than 1% solids, a lesser volume is used so that 10 g of solids (dry weight) will be extracted.

² The sample matrix may be amorphous for some samples. In general, when the CDDs/CDFs are in contact with a multiphase system in which one of the phases is water, they will be preferentially dispersed in or adsorbed on the alternate phase because of their low solubility in water.

³ Aqueous samples are filtered after spiking with the labeled compounds. The filtrate and the materials trapped on the filter are extracted separately, and the extracts are combined for cleanup and analysis.

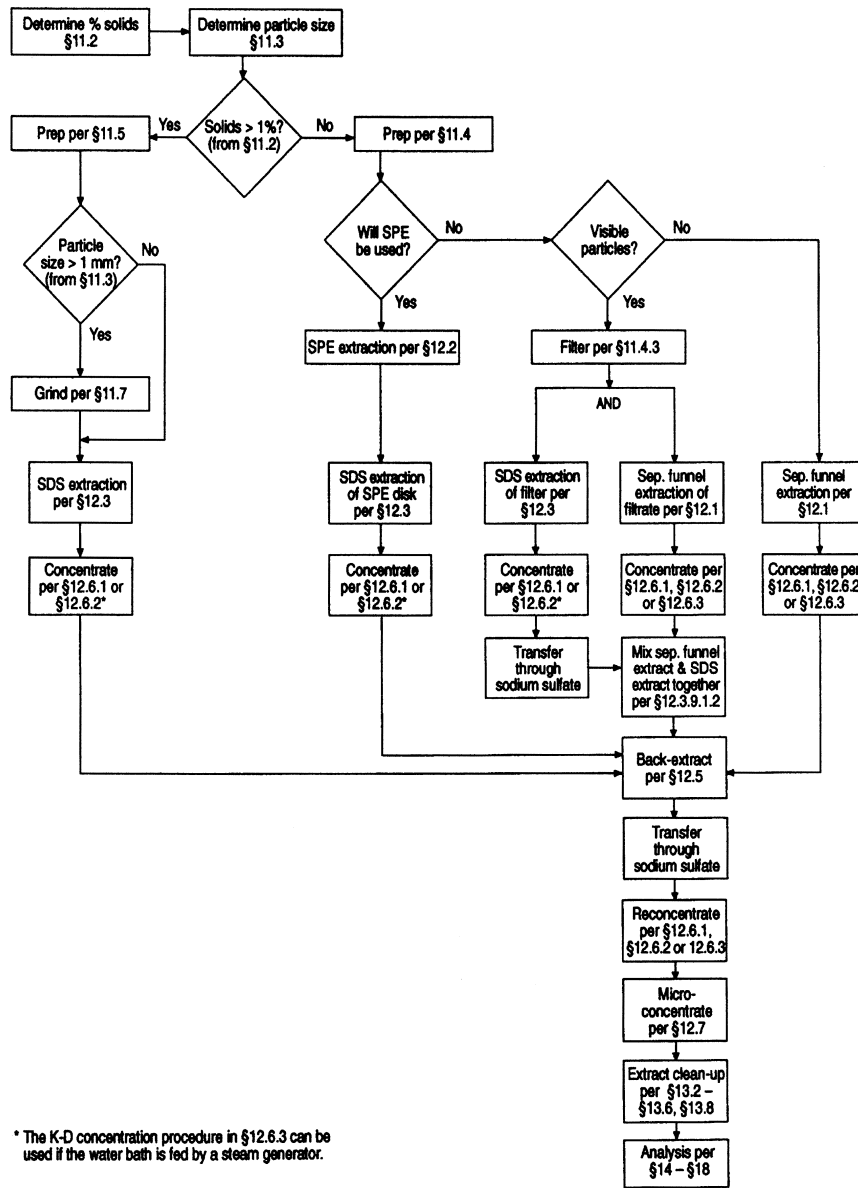

* The K-D concentration procedure in §12.6.3 can be used if the water bath is fed by a steam generator.

52-028-1A

Figure 1. Flow Chart for Analysis of Aqueous and Solid Samples

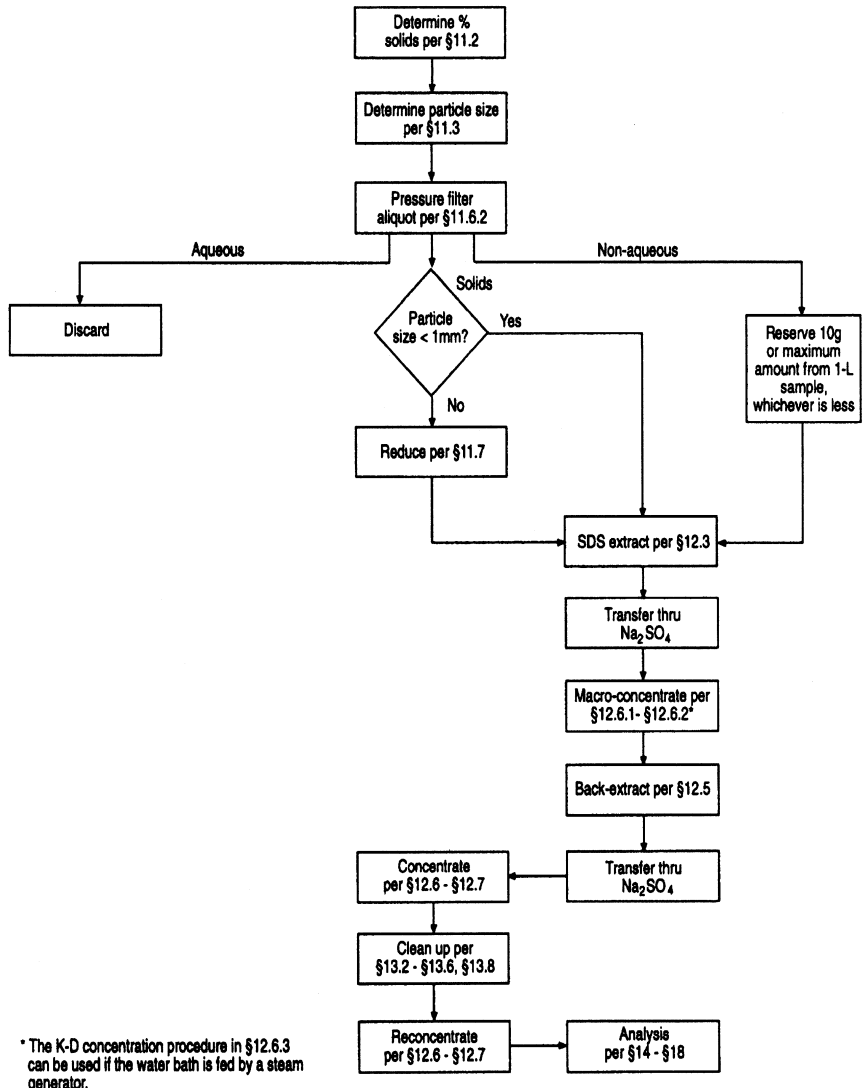
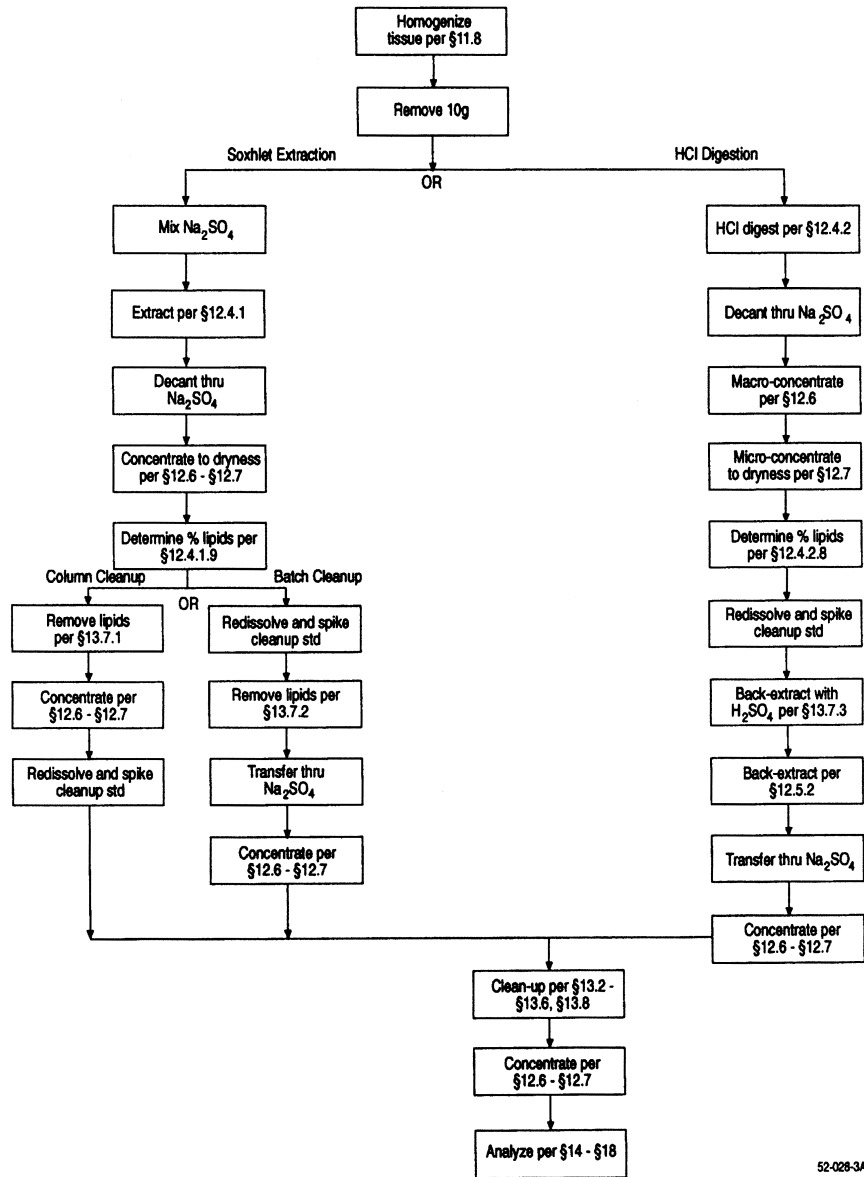

Figure 2. Flow Chart for Analysis of Multi-Phase Samples

52-028-2A



52-028-3A

Figure 3. Flow Chart for Analysis of Tissue Samples

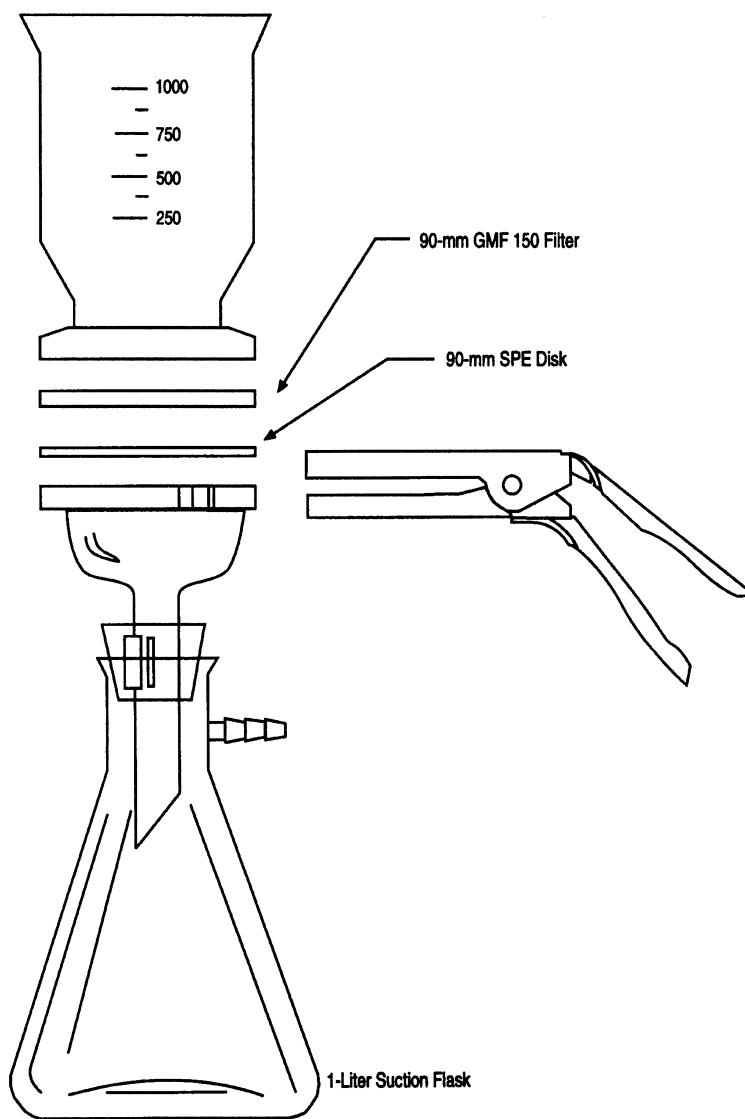
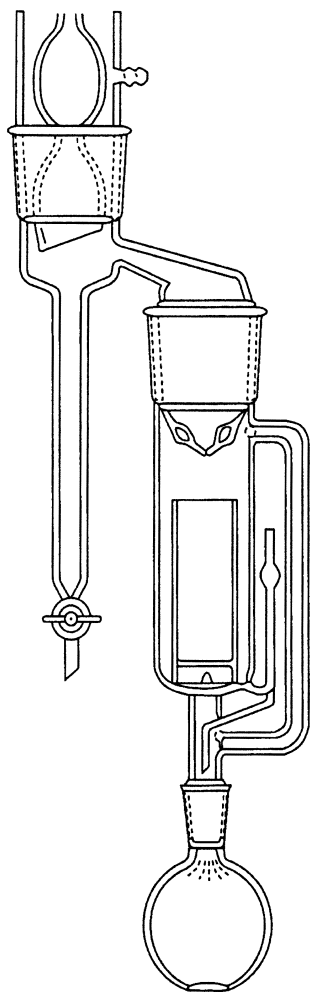

Figure 4. Solid-Phase Extraction Apparatus

52-027-1A



52-027-2A

Figure 5. Soxhlet/Dean-Stark Extractor

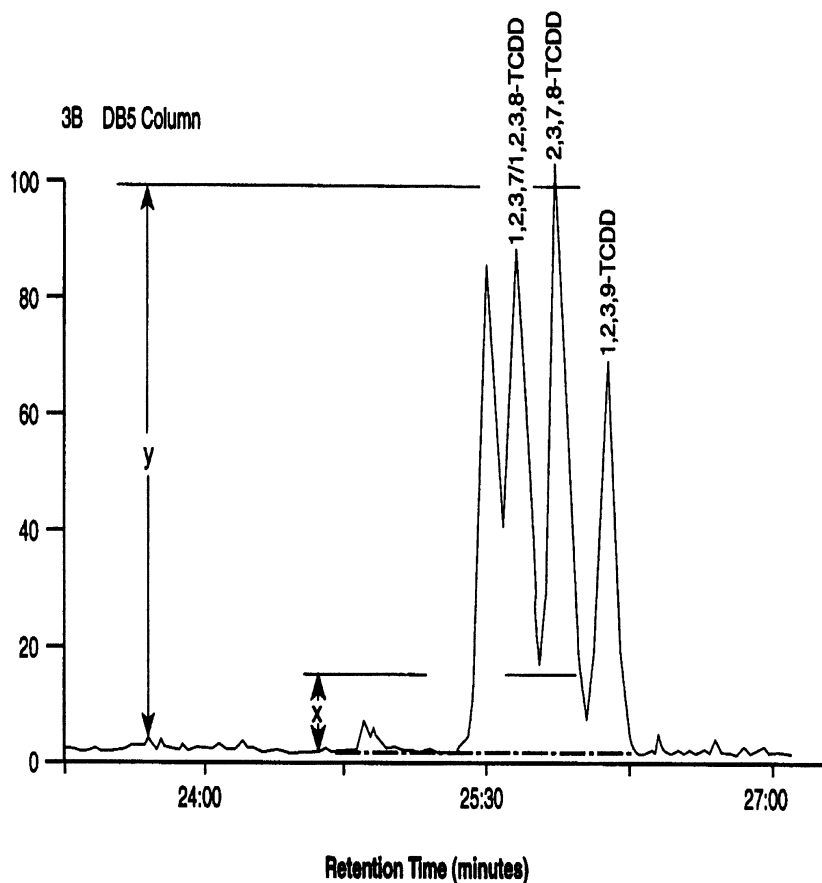

Figure 6. Isomer-Specific Separation of 2,3,7,8-TCDD on DB-5 Column

52-027-03

6-May-88 Sir: Voltage 705 Sys: DB5US
 Sample 1 Injection 1 Group 1 Mass 305.8987
 Text: Column Performance

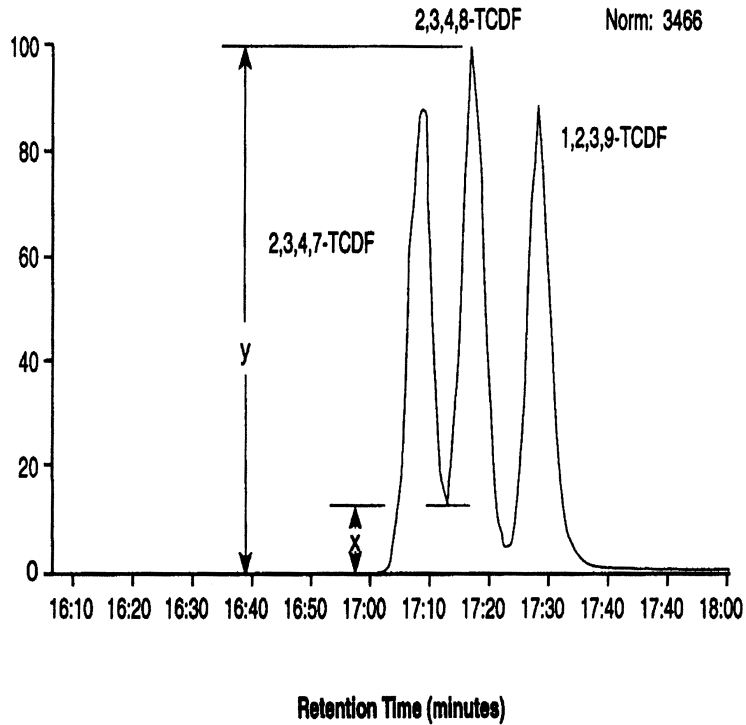

Figure 7. Isomer-Specific Separation of 2,3,7,8-TCDF on DB-5 Column

52-027-4A

24.0 Glossary of Definitions and Purposes

These definitions and purposes are specific to this method but have been conformed to common usage as much as possible.

24.1 Units of weight and Measure and Their Abbreviations.

24.1.1 Symbols:

- °C—degrees Celsius
- μL—microliter
- μm—micrometer
- <—less than
- >—greater than
- %—percent

24.1.2 Alphabetical abbreviations:

- amp—ampere
- cm—centimeter
- g—gram
- h—hour
- D—inside diameter
- in.—inch
- L—liter
- M—Molecular ion
- m—meter
- mg—milligram
- min—minute
- mL—milliliter
- mm—millimeter
- m/z—mass-to-charge ratio

N—normal; gram molecular weight of solute divided by hydrogen equivalent of solute, per liter of solution

OD—outside diameter

pg—picogram

ppb—part-per-billion

ppm—part-per-million

ppq—part-per-quadrillion

ppt—part-per-trillion

psig—pounds-per-square inch gauge

v/v—volume per unit volume

w/v—weight per unit volume

24.2 Definitions and Acronyms (in Alphabetical Order).

Analyte—A CDD or CDF tested for by this method. The analytes are listed in Table 1.

Calibration Standard (CAL)—A solution prepared from a secondary standard and/or stock solutions and used to calibrate the response of the instrument with respect to analyte concentration.

Calibration Verification Standard (VER)—The mid-point calibration standard (CS3) that is used in to verify calibration. See Table 4.

CDD—Chlorinated Dibenzo-p-ioxin—The isomers and congeners of tetra-through octachlorodibenzo-p-dioxin.

CDF—Chlorinated Dibenzofuran—The isomers and congeners of tetra-through octachlorodibenzofuran.

CS1, CS2, CS3, CS4, CS5—See Calibration standards and Table 4.

Field Blank—An aliquot of reagent water or other reference matrix that is placed in a sample container in the laboratory or the field, and treated as a sample in all respects, including exposure to sampling site conditions, storage, preservation, and all analytical procedures. The purpose of the field blank is to determine if the field or sample transporting procedures and environments have contaminated the sample.

GC—Gas chromatograph or gas chromatography.

GPC—Gel permeation chromatograph or gel permeation chromatography.

HPLC—High performance liquid chromatograph or high performance liquid chromatography.

HRGC—High resolution GC.

HRMS—High resolution MS.

IPR—Initial precision and recovery; four aliquots of the diluted PAR standard analyzed to establish the ability to generate acceptable precision and accuracy. An IPR is performed prior to the first time this method is used and any time the method or instrumentation is modified.

K-D—Kuderna-Danish concentrator; a device used to concentrate the analytes in a solvent.

Laboratory Blank—See method blank.

Laboratory Control sample (LCS)—See ongoing precision and recovery standard (OPR).

Laboratory Reagent Blank—See method blank.

May—This action, activity, or procedural step is neither required nor prohibited.

May Not—This action, activity, or procedural step is prohibited.

Method Blank—An aliquot of reagent water that is treated exactly as a sample including exposure to all glassware, equipment, solvents, reagents, internal standards, and surrogates that are used with samples. The method blank is used to determine if analytes or interferences are present in the laboratory environment, the reagents, or the apparatus.

Minimum Level (ML)—The level at which the entire analytical system must give a recognizable signal and acceptable calibration point for the analyte. It is equivalent to the concentration of the lowest calibration standard, assuming that all method-specified sample weights, volumes, and cleanup procedures have been employed.

MS—Mass spectrometer or mass spectrometry.

Must—This action, activity, or procedural step is required.

OPR—Ongoing precision and recovery standard (OPR); a laboratory blank spiked with known quantities of analytes. The OPR is analyzed exactly like a sample. Its purpose is to assure that the results produced by the laboratory remain within the limits specified in this method for precision and recovery.

PAR—Precision and recovery standard; secondary standard that is diluted and spiked to form the IPR and OPR.

PFK—Perfluorokerosene; the mixture of compounds used to calibrate the exact m/z scale in the HRMS.

Preparation Blank—See method blank.

Primary Dilution Standard—A solution containing the specified analytes that is purchased or prepared from stock solutions and diluted as needed to prepare calibration solutions and other solutions.

Quality Control Check Sample (QCS)—A sample containing all or a subset of the analytes at known concentrations. The QCS is obtained from a source external to the laboratory or is prepared from a source of standards different from the source of calibration standards. It is used to check laboratory performance with test materials prepared external to the normal preparation process.

Reagent Water—Water demonstrated to be free from the analytes of interest and potentially interfering substances at the method detection limit for the analyte.

Relative Standard Deviation (RSD)—The standard deviation times 100 divided by the mean. Also termed "coefficient of variation."

RF—Response factor. See Section 10.6.1.

RR—Relative response. See Section 10.5.2.

RSD—See relative standard deviation.

SDS—Soxhlet/Dean-Stark extractor; an extraction device applied to the extraction of solid and semi-solid materials (Reference 7).

Should—This action, activity, or procedural step is suggested but not required.

SICP—Selected ion current profile; the line described by the signal at an exact m/z.

SPE—Solid-phase extraction; an extraction technique in which an analyte is extracted from an aqueous sample by passage over or through a material capable of reversibly adsorbing the analyte. Also termed liquid-solid extraction.

Stock Solution—A solution containing an analyte that is prepared using a reference material traceable to EPA, the National Institute of Science and Technology (NIST), or a source that will attest to the purity and authenticity of the reference material.

TCDD—Tetrachlorodibenzo-p-dioxin.

TCDF—Tetrachlorodibenzofuran.

VER—See calibration verification standard.

METHOD 1624 REVISION B—VOLATILE ORGANIC COMPOUNDS BY ISOTOPE DILUTION GC/MS

1. Scope and Application

1.1 This method is designed to determine the volatile toxic organic pollutants associated with the 1976 Consent Decree and additional compounds amenable to purge and trap gas chromatography-mass spectrometry (GC/MS).

1.2 The chemical compounds listed in table 1 may be determined in municipal and industrial discharges by this method. The method is designed to meet the survey requirements of Effluent Guidelines Division (EGD) and the National Pollutants Discharge Elimination System (NPDES) under 40 CFR 136.1 and 136.5. Any modifications of this method, beyond those expressly permitted, shall be considered as major modifications subject to application and approval of alternate test procedures under 40 CFR 136.4 and 136.5.

1.3 The detection limit of this method is usually dependent on the level of interferences rather than instrumental limitations. The limits in table 2 represent the minimum quantity that can be detected with no interferences present.

1.4 The GC/MS portions of this method are for use only by analysts experienced with GC/MS or under the close supervision of such qualified persons. Laboratories unfamiliar with the analyses of environmental samples by GC/MS should run the performance tests in reference 1 before beginning.

2. Summary of Method

2.1 Stable isotopically labeled analogs of the compounds of interest are added to a 5 mL water sample. The sample is purged at 20–25 °C with an inert gas in a specially designed chamber. The volatile organic com-

pounds are transferred from the aqueous phase into the gaseous phase where they are passed into a sorbent column and trapped. After purging is completed, the trap is backflushed and heated rapidly to desorb the compounds into a gas chromatograph (GC). The compounds are separated by the GC and detected by a mass spectrometer (MS) (references 2 and 3). The labeled compounds serve to correct the variability of the analytical technique.

2.2 Identification of a compound (qualitative analysis) is performed by comparing the GC retention time and the background corrected characteristic spectral masses with those of authentic standards.

2.3 Quantitative analysis is performed by GC/MS using extracted ion current profile (EICP) areas. Isotope dilution is used when labeled compounds are available; otherwise, an internal standard method is used.

2.4 Quality is assured through reproducible calibration and testing of the purge and trap and GC/MS systems.

3. Contamination and Interferences

3.1 Impurities in the purge gas, organic compounds out-gassing from the plumbing upstream of the trap, and solvent vapors in the laboratory account for the majority of contamination problems. The analytical system is demonstrated to be free from interferences under conditions of the analysis by analyzing blanks initially and with each sample lot (samples analyzed on the same 8 hr shift), as described in Section 8.5.

3.2 Samples can be contaminated by diffusion of volatile organic compounds (particularly methylene chloride) through the bottle seal during shipment and storage. A field blank prepared from reagent water and carried through the sampling and handling protocol serves as a check on such contamination.

3.3 Contamination by carry-over can occur when high level and low level samples are analyzed sequentially. To reduce carry-over, the purging device and sample syringe are rinsed between samples with reagent water. When an unusually concentrated sample is encountered, it is followed by analysis of a reagent water blank to check for carry-over. For samples containing large amounts of water soluble materials, suspended solids, high boiling compounds, or high levels of purgeable compounds, the purge device is washed with soap solution, rinsed with tap and distilled water, and dried in an oven at 100–125 °C. The trap and other parts of the system are also subject to contamination; therefore, frequent bakeout and purging of the entire system may be required.

3.4 Interferences resulting from samples will vary considerably from source to source, depending on the diversity of the industrial complex or municipality being sampled.

4. Safety

4.1 The toxicity or carcinogenicity of each compound or reagent used in this method has not been precisely determined; however, each chemical compound should be treated as a potential health hazard. Exposure to these compounds should be reduced to the lowest possible level. The laboratory is responsible for maintaining a current awareness file of OSHA regulations regarding the safe handling of the chemicals specified in this method. A reference file of data handling sheets should also be made available to all personnel involved in these analyses. Additional information on laboratory safety can be found in references 4-6.

4.2 The following compounds covered by this method have been tentatively classified as known or suspected human or mammalian carcinogens: benzene, carbon tetrachloride, chloroform, and vinyl chloride. Primary standards of these toxic compounds should be prepared in a hood, and a NIOSH/MESA approved toxic gas respirator should be worn when high concentrations are handled.

5. Apparatus and Materials

5.1 Sample bottles for discrete sampling.

5.1.1 Bottle—25 to 40 mL with screw cap (Pierce 13075, or equivalent). Detergent wash, rinse with tap and distilled water, and dry at >105 °C for one hr minimum before use.

5.1.2 Septum—Teflon-faced silicone (Pierce 12722, or equivalent), cleaned as above and baked at 100-200 °C, for one hour minimum.

5.2 Purge and trap device—consists of purging device, trap, and desorber. Complete devices are commercially available.

5.2.1 Purging device—designed to accept 5 mL samples with water column at least 3 cm deep. The volume of the gaseous head space between the water and trap shall be less than 15 mL. The purge gas shall be introduced less than 5 mm from the base of the water column and shall pass through the water as bubbles with a diameter less than 3 mm. The purging device shown in Figure 1 meets these criteria.

5.2.2 Trap—25 to 30 cm × 2.5 mm i.d. minimum, containing the following:

5.2.2.1 Methyl silicone packing—one ±0.2 cm, 3 percent OV-1 on 60/80 mesh Chromosorb W, or equivalent.

5.2.2.2 Porous polymer—15 ±1.0 cm, Tenax GC (2,6-diphenylene oxide polymer), 60/80 mesh, chromatographic grade, or equivalent.

5.2.2.3 Silica gel—8 ±1.0 cm, Davison Chemical, 35/60 mesh, grade 15, or equivalent. The trap shown in Figure 2 meets these specifications.

5.2.3 Desorber—shall heat the trap to 175 ±5 °C in 45 seconds or less. The polymer section of the trap shall not exceed 180 °C, and the remaining sections shall not exceed 220

°C. The desorber shown in Figure 2 meets these specifications.

5.2.4 The purge and trap device may be a separate unit or coupled to a GC as shown in Figures 3 and 4.

5.3 Gas chromatograph—shall be linearly temperature programmable with initial and final holds, shall contain a glass jet separator as the MS interface, and shall produce results which meet the calibration (Section 7), quality assurance (Section 8), and performance tests (Section 11) of this method.

5.3.1 Column—2.8 ±0.4 m × 2 ±0.5 mm i. d. glass, packed with one percent SP-1000 on Carbopak B, 60/80 mesh, or equivalent.

5.4 Mass spectrometer—70 eV electron impact ionization; shall repetitively scan from 20 to 250 amu every 2-3 seconds, and produce a unit resolution (valleys between m/z 174-176 less than 10 percent of the height of the m/z 175 peak), background corrected mass spectrum from 50 ng 4-bromo-fluorobenzene (BFB) injected into the GC. The BFB spectrum shall meet the mass-intensity criteria in Table 3. All portions of the GC column, transfer lines, and separator which connect the GC column to the ion source shall remain at or above the column temperature during analysis to preclude condensation of less volatile compounds.

5.5 Data system—shall collect and record MS data, store mass intensity data in spectral libraries, process GC/MS data and generate reports, and shall calculate and record response factors.

5.5.1 Data acquisition—mass spectra shall be collected continuously throughout the analysis and stored on a mass storage device.

5.5.2 Mass spectral libraries—user created libraries containing mass spectra obtained from analysis of authentic standards shall be employed to reverse search GC/MS runs for the compounds of interest (Section 7.2).

5.5.3 Data processing—the data system shall be used to search, locate, identify, and quantify the compounds of interest in each GC/MS analysis. Software routines shall be employed to compute retention times and EICP areas. Displays of spectra, mass chromatograms, and library comparisons are required to verify results.

5.5.4 Response factors and multipoint calibrations—the data system shall be used to record and maintain lists of response factors (response ratios for isotope dilution) and generate multi-point calibration curves (Section 7). Computations of relative standard deviation (coefficient of variation) are useful for testing calibration linearity. Statistics on initial and on-going performance shall be maintained (Sections 8 and 11).

5.6 Syringes—5 mL glass hypodermic, with Luer-lok tips.

5.7 Micro syringes—10, 25, and 100 uL.

5.8 Syringe valves—2-way, with Luer ends (Teflon or Kel-F).

5.9 Syringe—5 mL, gas-tight, with shut-off valve.

5.10 Bottles—15 mL, screw-cap with Teflon liner.

5.11 Balance—analytical, capable of weighing 0.1 mg.

6. Reagents and Standards

6.1 Reagent water—water in which the compounds of interest and interfering compounds are not detected by this method (Section 11.7). It may be generated by any of the following methods:

6.1.1 Activated carbon—pass tap water through a carbon bed (Calgon Filtrasorb-300, or equivalent).

6.1.2 Water purifier—pass tap water through a purifier (Millipore Super Q, or equivalent).

6.1.3 Boil and purge—heat tap water to 90–100 °C and bubble contaminant free inert gas through it for approx one hour. While still hot, transfer the water to screw-cap bottles and seal with a Teflon-lined cap.

6.2 Sodium thiosulfate—ACS granular.

6.3 Methanol—pesticide quality or equivalent.

6.4 Standard solutions—purchased as solution or mixtures with certification to their purity, concentration, and authenticity, or prepared from materials of known purity and composition. If compound purity is 96 percent or greater, the weight may be used without correction to calculate the concentration of the standard.

6.5 Preparation of stock solutions—prepare in methanol using liquid or gaseous standards per the steps below. Observe the safety precautions given in Section 4.

6.5.1 Place approx 9.8 mL of methanol in a 10 mL ground glass stoppered volumetric flask. Allow the flask to stand unstoppered for approximately 10 minutes or until all methanol wetted surfaces have dried. In each case, weigh the flask, immediately add the compound, then immediately reweigh to prevent evaporation losses from affecting the measurement.

6.5.1.1 Liquids—using a 100 μ L syringe, permit 2 drops of liquid to fall into the methanol without contacting the neck of the flask. Alternatively, inject a known volume of the compound into the methanol in the flask using a micro-syringe.

6.5.1.2 Gases (chloromethane, bromomethane, chloroethane, vinyl chloride)—fill a valved 5 mL gas-tight syringe with the compound. Lower the needle to approximately 5 mm above the methanol meniscus. Slowly introduce the compound above the surface of the meniscus. The gas will dissolve rapidly in the methanol.

6.5.2 Fill the flask to volume, stopper, then mix by inverting several times. Calculate the concentration in mg/mL (μ g/ μ L) from the weight gain (or density if a known volume was injected).

6.5.3 Transfer the stock solution to a Teflon sealed screw-cap-bottle. Store, with minimal headspace, in the dark at –10 to –20 °C.

6.5.4 Prepare fresh standards weekly for the gases and 2-chloroethylvinyl ether. All other standards are replaced after one month, or sooner if comparison with check standards indicate a change in concentration. Quality control check standards that can be used to determine the accuracy of calibration standards are available from the US Environmental Protection Agency, Environmental Monitoring and Support Laboratory, Cincinnati, Ohio.

6.6 Labeled compound spiking solution— from stock standard solutions prepared as above, or from mixtures, prepare the spiking solution to contain a concentration such that a 5–10 μ L spike into each 5 mL sample, blank, or aqueous standard analyzed will result in a concentration of 20 μ g/L of each labeled compound. For the gases and for the water soluble compounds (acrolein, acrylonitrile, acetone, diethyl ether, and MEK), a concentration of 100 μ g/L may be used. Include the internal standards (Section 7.5) in this solution so that a concentration of 20 μ g/L in each sample, blank, or aqueous standard will be produced.

6.7 Secondary standards—using stock solutions, prepare a secondary standard in methanol to contain each pollutant at a concentration of 500 μ g/mL. For the gases and water soluble compounds (Section 6.6), a concentration of 2.5 mg/mL may be used.

6.7.1 Aqueous calibration standards—using a 25 μ L syringe, add 20 μ L of the secondary standard (Section 6.7) to 50, 100, 200, 500, and 1000 mL of reagent water to produce concentrations of 200, 100, 50, 20, and 10 μ g/L, respectively. If the higher concentration standard for the gases and water soluble compounds was chosen (Section 6.6), these compounds will be at concentrations of 1000, 500, 250, 100, and 50 μ g/L in the aqueous calibration standards.

6.7.2 Aqueous performance standard—an aqueous standard containing all pollutants, internal standards, labeled compounds, and BFB is prepared daily, and analyzed each shift to demonstrate performance (Section 11). This standard shall contain either 20 or 100 μ g/L of the labeled and pollutant gases and water soluble compounds, 10 μ g/L BFB, and 20 μ g/L of all other pollutants, labeled compounds, and internal standards. It may be the nominal 20 μ g/L aqueous calibration standard (Section 6.7.1).

6.7.3 A methanolic standard containing all pollutants and internal standards is prepared to demonstrate recovery of these compounds when syringe injection and purge and trap analyses are compared. This standard shall contain either 100 μ g/mL or 500 μ g/mL of the gases and water soluble compounds, and 100 μ g/mL of the remaining pollutants

and internal standards (consistent with the amounts in the aqueous performance standard in 6.7.2).

6.7.4 Other standards which may be needed are those for test of BFB performance (Section 7.1) and for collection of mass spectra for storage in spectral libraries (Section 7.2).

7. Calibration

7.1 Assemble the gas chromatographic apparatus and establish operating conditions given in table 2. By injecting standards into the GC, demonstrate that the analytical system meets the detection limits in table 2 and the mass-intensity criteria in table 3 for 50 ng BFB.

7.2 Mass spectral libraries—detection and identification of the compound of interest are dependent upon the spectra stored in user created libraries.

7.2.1 Obtain a mass spectrum of each pollutant and labeled compound and each internal standard by analyzing an authentic standard either singly or as part of a mixture in which there is no interference between closely eluted components. That only a single compound is present is determined by examination of the spectrum. Fragments not attributable to the compound under study indicate the presence of an interfering compound. Adjust the analytical conditions and scan rate (for this test only) to produce an undistorted spectrum at the GC peak maximum. An undistorted spectrum will usually be obtained if five complete spectra are collected across the upper half of the GC peak. Software algorithms designed to “enhance” the spectrum may eliminate distortion, but may also eliminate authentic m/z 's or introduce other distortion.

7.2.3 The authentic reference spectrum is obtained under BFB tuning conditions (Section 7.1 and table 3) to normalize it to spectra from other instruments.

7.2.4 The spectrum is edited by saving the 5 most intense mass spectral peaks and all other mass spectral peaks greater than 10 percent of the base peak. This spectrum is stored for reverse search and for compound confirmation.

7.3 Assemble the purge and trap device. Pack the trap as shown in Figure 2 and condition overnight at 170–180 °C by backflushing with an inert gas at a flow rate of 20–30 mL/min. Condition traps daily for a minimum of 10 minutes prior to use.

7.3.1 Analyze the aqueous performance standard (Section 6.7.2) according to the purge and trap procedure in Section 10. Compute the area at the primary m/z (table 4) for each compound. Compare these areas to those obtained by injecting one μ L of the methanolic standard (Section 6.7.3) to determine compound recovery. The recovery shall be greater than 20 percent for the water soluble compounds, and 60–110 percent for all

other compounds. This recovery is demonstrated initially for each purge and trap GC/MS system. The test is repeated only if the purge and trap or GC/MS systems are modified in any way that might result in a change in recovery.

7.3.2 Demonstrate that 100 ng toluene (or toluene-d8) produces an area at m/z 91 (or 99) approx one-tenth that required to exceed the linear range of the system. The exact value must be determined by experience for each instrument. It is used to match the calibration range of the instrument to the analytical range and detection limits required.

7.4 Calibration by isotope dilution—the isotope dilution approach is used for the purgeable organic compounds when appropriate labeled compounds are available and when interferences do not preclude the analysis. If labeled compounds are not available, or interferences are present, internal standard methods (Section 7.5 or 7.6) are used. A calibration curve encompassing the concentration range of interest is prepared for each compound determined. The relative response (RR) vs concentration (μ g/L) is plotted or computed using a linear regression. An example of a calibration curve for toluene using toluene-d8 is given in figure 5. Also shown are the ± 10 percent error limits (dotted lines). Relative response is determined according to the procedures described below. A minimum of five data points are required for calibration (Section 7.4.4).

7.4.1 The relative response (RR) of pollutant to labeled compound is determined from isotope ratio values calculated from acquired data. Three isotope ratios are used in this process:

R_x = the isotope ratio measured in the pure pollutant (figure 6A).

R_y = the isotope ratio of pure labeled compound (figure 6B).

R_m = the isotope ratio measured in the analytical mixture of the pollutant and labeled compounds (figure 6C).

The correct way to calculate RR is: $RR = (R_y - R_m) / (R_x + 1) / (R_m - R_x) / (R_y + 1)$. If R_m is not between $2R_y$ and $0.5R_x$, the method does not apply and the sample is analyzed by internal or external standard methods (Section 7.5 or 7.6).

7.4.2 In most cases, the retention times of the pollutant and labeled compound are the same and isotope ratios (R 's) can be calculated from the EICP areas, where: $R = (\text{area at } m_1/z) / (\text{area at } m_2/z)$. If either of the areas is zero, it is assigned a value of one in the calculations; that is, if: area of $m_1/z = 50721$, and area of $m_2/z = 0$, then $R = 50721/1 = 50720$. The m/z 's are always selected such that $R_x > R_y$. When there is a difference in retention times (RT) between the pollutant and labeled compounds, special precautions are required to determine the isotope ratios.

R_x , R_y , and R_m are defined as follows:

$$R_x = [\text{area } m_1/z \text{ (at } RT_1)]/1$$

$$R_y = 1/[\text{area } m_2/z \text{ (at } RT_2)]$$

$$R_m = [\text{area } m_1/z \text{ (at } RT_1)]/[\text{area } m_2/z \text{ (at } RT_2)]$$

7.4.3 An example of the above calculations can be taken from the data plotted in figure 6 for toluene and toluene-d8. For these data, $R_x=168920/1=168900$, $R_y=1/60960=0.00001640$, and $R_m=96868/82508=1.174$. The RR for the above data is then calculated using the equation given in Section 7.4.1. For the example, $RR=1.174$.

NOTE: Not all labeled compounds elute before their pollutant analogs.

7.4.4 To calibrate the analytical system by isotope dilution, analyze a 5 mL aliquot of each of the aqueous calibration standards (Section 6.7.1) spiked with an appropriate constant amount of the labeled compound spiking solution (Section 6.6), using the purge and trap procedure in section 10. Compute the RR at each concentration.

7.4.5 Linearity—if the ratio of relative response to concentration for any compound is constant (less than 20 percent coefficient of variation) over the 5 point calibration range, an averaged relative response/concentration ratio may be used for that compound; otherwise, the complete calibration curve for that compound shall be used over the 5 point calibration range.

7.5 Calibration by internal standard—used when criteria for isotope dilution (Section 7.4) cannot be met. The method is applied to pollutants having no labeled analog and to the labeled compounds. The internal standards used for volatiles analyses are bromochloromethane, 2-bromo-1-chloropropane, and 1,4-dichlorobutane. Concentrations of the labeled compounds and pollutants without labeled analogs are computed relative to the nearest eluted internal standard, as shown in table 2.

7.5.1 Response factors—calibration requires the determination of response factors (RF) which are defined by the following equation:

$RF = (A_s \times C_{is}) / (A_{is} \times C_s)$, where A_s is the EICP area at the characteristic m/z for the compound in the daily standard. A_{is} is the EICP area at the characteristic m/z for the internal standard.

C_{is} is the concentration (ug/L) of the internal standard

C_s is the concentration of the pollutant in the daily standard.

7.5.2 The response factor is determined at 10, 20, 50, 100, and 200 ug/L for the pollutants (optionally at five times these concentrations for gases and water soluble pollutants—see Section 6.7), in a way analogous to that for calibration by isotope dilution (Section 7.4.4). The RF is plotted against concentration for each compound in the standard (C_s) to produce a calibration curve.

7.5.3 Linearity—if the response factor (RF) for any compound is constant (less than 35 percent coefficient of variation) over the 5

point calibration range, an averaged response factor may be used for that compound; otherwise, the complete calibration curve for that compound shall be used over the 5 point range.

7.6 Combined calibration—by adding the isotopically labeled compounds and internal standards (Section 6.6) to the aqueous calibration standards (Section 6.7.1), a single set of analyses can be used to produce calibration curves for the isotope dilution and internal standard methods. These curves are verified each shift (Section 11.5) by purging the aqueous performance standard (Section 6.7.2). Recalibration is required only if calibration and on-going performance (Section 11.5) criteria cannot be met.

8. Quality Assurance/Quality Control

8.1 Each laboratory that uses this method is required to operate a formal quality assurance program. The minimum requirements of this program consist of an initial demonstration of laboratory capability, analysis of samples spiked with labeled compounds to evaluate and document data quality, and analysis of standards and blanks as tests of continued performance. Laboratory performance is compared to established performance criteria to determine if the results of analyses meet the performance characteristics of the method.

8.1.1 The analyst shall make an initial demonstration of the ability to generate acceptable accuracy and precision with this method. This ability is established as described in Section 8.2.

8.1.2 The analyst is permitted to modify this method to improve separations or lower the costs of measurements, provided all performance specifications are met. Each time a modification is made to the method, the analyst is required to repeat the procedure in Section 8.2 to demonstrate method performance.

8.1.3 Analyses of blanks are required to demonstrate freedom from contamination and that the compounds of interest and interfering compounds have not been carried over from a previous analysis (Section 3). The procedures and criteria for analysis of a blank are described in Sections 8.5 and 11.7.

8.1.4 The laboratory shall spike all samples with labeled compounds to monitor method performance. This test is described in Section 8.3. When results of these spikes indicate atypical method performance for samples, the samples are diluted to bring method performance within acceptable limits (Section 14.2).

8.1.5 The laboratory shall, on an on-going basis, demonstrate through the analysis of the aqueous performance standard (Section 6.7.2) that the analysis system is in control. This procedure is described in Sections 11.1 and 11.5.

8.1.6 The laboratory shall maintain records to define the quality of data that is generated. Development of accuracy statements is described in Sections 8.4 and 11.5.2.

8.2 Initial precision and accuracy—to establish the ability to generate acceptable precision and accuracy, the analyst shall perform the following operations:

8.2.1 Analyze two sets of four 5-mL aliquots (8 aliquots total) of the aqueous performance standard (Section 6.7.2) according to the method beginning in Section 10.

8.2.2 Using results of the first set of four analyses in Section 8.2.1, compute the average recovery (\bar{X}) in $\mu\text{g/L}$ and the standard deviation of the recovery (s) in $\mu\text{g/L}$ for each compound, by isotope dilution for pollutants with a labeled analog, and by internal standard for labeled compounds and pollutants with no labeled analog.

8.2.3 For each compound, compare s and \bar{X} with the corresponding limits for initial precision and accuracy found in table 5. If s and \bar{X} for all compounds meet the acceptance criteria, system performance is acceptable and analysis of blanks and samples may begin. If individual \bar{X} falls outside the range for accuracy, system performance is unacceptable for that compound.

NOTE: The large number of compounds in table 5 present a substantial probability that one or more will fail one of the acceptance criteria when all compounds are analyzed. To determine if the analytical system is out of control, or if the failure can be attributed to probability, proceed as follows:

8.2.4 Using the results of the second set of four analyses, compute s and \bar{X} for only those compounds which failed the test of the first set of four analyses (Section 8.2.3). If these compounds now pass, system performance is acceptable for all compounds and analysis of blanks and samples may begin. If, however, any of the same compounds fail again, the analysis system is not performing properly for the compound(s) in question. In this event, correct the problem and repeat the entire test (Section 8.2.1).

8.3 The laboratory shall spike all samples with labeled compounds to assess method performance on the sample matrix.

8.3.1 Spike and analyze each sample according to the method beginning in Section 10.

8.3.2 Compute the percent recovery (P) of the labeled compounds using the internal standard method (Section 7.5).

8.3.3 Compare the percent recovery for each compound with the corresponding labeled compound recovery limit in table 5. If the recovery of any compound falls outside its warning limit, method performance is unacceptable for that compound in that sample. Therefore, the sample matrix is complex and the sample is to be diluted and reanalyzed, per Section 14.2.

8.4 As part of the QA program for the laboratory, method accuracy for wastewater samples shall be assessed and records shall be maintained. After the analysis of five wastewater samples for which the labeled compounds pass the tests in Section 8.3.3, compute the average percent recovery (P) and the standard deviation of the percent recovery (s_p) for the labeled compounds only. Express the accuracy assessment as a percent recovery interval from $P - 2s_p$ to $P + 2s_p$. For example, if $P = 90\%$ and $s_p = 10\%$, the accuracy interval is expressed as 70–110%. Update the accuracy assessment for each compound on a regular basis (e.g. after each 5–10 new accuracy measurements).

8.5 Blanks—reagent water blanks are analyzed to demonstrate freedom from carry-over (Section 3) and contamination.

8.5.1 The level at which the purge and trap system will carry greater than 5 $\mu\text{g/L}$ of a pollutant of interest (table 1) into a succeeding blank shall be determined by analyzing successively larger concentrations of these compounds. When a sample contains this concentration or more, a blank shall be analyzed immediately following this sample to demonstrate no carry-over at the 5 $\mu\text{g/L}$ level.

8.5.2 With each sample lot (samples analyzed on the same 8 hr shift), a blank shall be analyzed immediately after analysis of the aqueous performance standard (Section 11.1) to demonstrate freedom from contamination. If any of the compounds of interest (table 1) or any potentially interfering compound is found in a blank at greater than 10 $\mu\text{g/L}$ (assuming a response factor of 1 relative to the nearest eluted internal standard for compounds not listed in table 1), analysis of samples is halted until the source of contamination is eliminated and a blank shows no evidence of contamination at this level.

8.6 The specifications contained in this method can be met if the apparatus used is calibrated properly, then maintained in a calibrated state.

The standards used for calibration (Section 7), calibration verification (Section 11.5) and for initial (Section 8.2) and on-going (Section 11.5) precision and accuracy should be identical, so that the most precise results will be obtained. The GC/MS instrument in particular will provide the most reproducible results if dedicated to the settings and conditions required for the analyses of volatiles by this method.

8.7 Depending on specific program requirements, field replicates may be collected to determine the precision of the sampling technique, and spiked samples may be required to determine the accuracy of the analysis when internal or external standard methods are used.

9. Sample Collection, Preservation, and Handling

9.1 Grab samples are collected in glass containers having a total volume greater than 20 mL. Fill sample bottles so that no air bubbles pass through the sample as the bottle is filled. Seal each bottle so that no air bubbles are entrapped. Maintain the hermetic seal on the sample bottle until time of analysis.

9.2 Samples are maintained at 0–4 °C from the time of collection until analysis. If the sample contains residual chlorine, add sodium thiosulfate preservative (10 mg/40 mL) to the empty sample bottles just prior to shipment to the sample site. EPA Methods 330.4 and 330.5 may be used for measurement of residual chlorine (Reference 8). If preservative has been added, shake bottle vigorously for one minute immediately after filling.

9.3 Experimental evidence indicates that some aromatic compounds, notably benzene, toluene, and ethyl benzene are susceptible to rapid biological degradation under certain environmental conditions. Refrigeration alone may not be adequate to preserve these compounds in wastewaters for more than seven days. For this reason, a separate sample should be collected, acidified, and analyzed when these aromatics are to be determined. Collect about 500 mL of sample in a clean container.

Adjust the pH of the sample to about 2 by adding HCl (1+1) while stirring. Check pH with narrow range (1.4 to 2.8) pH paper. Fill a sample container as described in Section 9.1. If residual chlorine is present, add sodium thiosulfate to a separate sample container and fill as in Section 9.1.

9.4 All samples shall be analyzed within 14 days of collection.

10. Purge, Trap, and GC/MS Analysis

10.1 Remove standards and samples from cold storage and bring to 20–25 °.

10.2 Adjust the purge gas flow rate to 40 ±4 mL/min. Attach the trap inlet to the purging device and set the valve to the purge mode (figure 3). Open the syringe valve located on the purging device sample introduction needle (figure 1).

10.3 Remove the plunger from a 5-mL syringe and attach a closed syringe valve. Open the sample bottle and carefully pour the sample into the syringe barrel until it overflows. Replace the plunger and compress the sample. Open the syringe valve and vent any residual air while adjusting the sample volume to 5.0 mL. Because this process of taking an aliquot destroys the validity of the sample for future analysis, fill a second syringe at this time to protect against possible loss of data. Add an appropriate amount of the labeled compound spiking solution (Sec-

tion 6.6) through the valve bore, then close the valve.

10.4 Attach the syringe valve assembly to the syringe valve on the purging device. Open both syringe valves and inject the sample into the purging chamber.

10.5 Close both valves and purge the sample for 11.0 ±0.1 minutes at 20–25 °C.

10.6 After the 11 minute purge time, attach the trap to the chromatograph and set the purge and trap apparatus to the desorb mode (figure 4). Desorb the trapped compounds into the GC column by heating the trap to 170–180 °C while backflushing with carrier gas at 20–60 mL/min for four minutes. Start MS data acquisition upon start of the desorb cycle, and start the GC column temperature program 3 minutes later. Table 1 summarizes the recommended operating conditions for the gas chromatograph. Included in this table are retention times and detection limits that were achieved under these conditions. Other columns may be used provided the requirements in Section 8 can be met. If the priority pollutant gases produce GC peaks so broad that the precision and recovery specifications (Section 8.2) cannot be met, the column may be cooled to ambient or sub-ambient temperatures to sharpen these peaks.

10.7 While analysis of the desorbed compounds proceeds, empty the purging chamber using the sample introduction syringe. Wash the chamber with two 5-mL portions of reagent water. After the purging device has been emptied, allow the purge gas to vent through the chamber until the frit is dry, so that it is ready for the next sample.

10.8 After desorbing the sample for four minutes, recondition the trap by returning to the purge mode. Wait 15 seconds, then close the syringe valve on the purging device to begin gas flow through the trap. Maintain the trap temperature at 170–180 °C. After approximately seven minutes, turn off the trap heater and open the syringe valve to stop the gas flow through the trap. When cool, the trap is ready for the next sample.

11. System Performance

11.1 At the beginning of each 8 hr shift during which analyses are performed, system calibration and performance shall be verified for all pollutants and labeled compounds. For these tests, analysis of the aqueous performance standard (Section 6.7.2) shall be used to verify all performance criteria. Adjustment and/or recalibration (per Section 7) shall be performed until all performance criteria are met. Only after all performance criteria are met may blanks and samples be analyzed.

11.2 BFB spectrum validity—the criteria in table 3 shall be met.

11.3 Retention times—the absolute retention times of all compounds shall approximate those given in Table 2.

11.4 GC resolution—the valley height between toluene and toluene-d8 (at m/z 91 and 99 plotted on the same graph) shall be less than 10 percent of the taller of the two peaks.

11.5 Calibration verification and on-going precision and accuracy—compute the concentration of each pollutant (Table 1) by isotope dilution (Section 7.4) for those compounds which have labeled analogs. Compute the concentration of each pollutant (Table 1) which has no labeled analog by the internal standard method (Section 7.5). Compute the concentration of the labeled compounds by the internal standard method. These concentrations are computed based on the calibration data determined in Section 7.

11.5.1 For each pollutant and labeled compound, compare the concentration with the corresponding limit for on-going accuracy in Table 5. If all compounds meet the acceptance criteria, system performance is acceptable and analysis of blanks and samples may continue. If any individual value falls outside the range given, system performance is unacceptable for that compound.

NOTE: The large number of compounds in Table 5 present a substantial probability that one or more will fail the acceptance criteria when all compounds are analyzed. To determine if the analytical system is out of control, or if the failure may be attributed to probability, proceed as follows:

11.5.1.1 Analyze a second aliquot of the aqueous performance standard (Section 6.7.2).

11.5.1.2 Compute the concentration for only those compounds which failed the first test (Section 11.5.1). If these compounds now pass, system performance is acceptable for all compounds and analyses of blanks and samples may proceed. If, however, any of the compounds fail again, the measurement system is not performing properly for these compounds. In this event, locate and correct the problem or recalibrate the system (Section 7), and repeat the entire test (Section 11.1) for all compounds.

11.5.2 Add results which pass the specification in 11.5.1.2 to initial (Section 8.2) and previous on-going data. Update QC charts to form a graphic representation of laboratory performance (Figure 7). Develop a statement of accuracy for each pollutant and labeled compound by calculating the average percentage recovery (R) and the standard deviation of percent recovery (s_r). Express the accuracy as a recovery interval from $R-2s_r$ to $R+2s_r$. For example, if $R=95\%$ and $s_r=5\%$, the accuracy is 85–105 percent.

12. *Qualitative Determination—Accomplished by Comparison of Data from Analysis of a Sample or Blank with Data from Analysis of the Shift Standard (Section 11.1). Identification is Confirmed When Spectra and Retention Times Agree Per the Criteria Below*

12.1 Labeled compounds and pollutants having no labeled analog:

12.1.1 The signals for all characteristic masses stored in the spectral library (Section 7.2.4) shall be present and shall maximize within the same two consecutive scans.

12.1.2 Either (1) the background corrected EICP areas, or (2) the corrected relative intensities of the mass spectral peaks at the GC peak maximum shall agree within a factor of two (0.5 to 2 times) for all masses stored in the library.

12.1.3 The retention time relative to the nearest eluted internal standard shall be within ± 7 scans or ± 20 seconds, whichever is greater.

12.2 Pollutants having a labeled analog:

12.2.1 The signals for all characteristic masses stored in the spectral library (Section 7.2.4) shall be present and shall maximize within the same two consecutive scans.

12.2.2 Either (1) the background corrected EICP areas, or (2) the corrected relative intensities of the mass spectral peaks at the GC peak maximum shall agree within a factor of two for all masses stored in the spectral library.

12.2.3 The retention time difference between the pollutant and its labeled analog shall agree within ± 2 scans or ± 6 seconds (whichever is greater) of this difference in the shift standard (Section 11.1).

12.3 Masses present in the experimental mass spectrum that are not present in the reference mass spectrum shall be accounted for by contaminant or background ions. If the experimental mass spectrum is contaminated, an experienced spectrometrist (Section 1.4) is to determine the presence or absence of the compound.

13. *Quantitative Determination*

13.1 Isotope dilution—by adding a known amount of a labeled compound to every sample prior to purging, correction for recovery of the pollutant can be made because the pollutant and its labeled analog exhibit the same effects upon purging, desorption, and gas chromatography. Relative response (RR) values for sample mixtures are used in conjunction with calibration curves described in Section 7.4 to determine concentrations directly, so long as labeled compound spiking levels are constant. For the toluene example given in Figure 6 (Section 7.4.3), RR would be equal to 1.174. For this RR value, the toluene calibration curve given in Figure 5 indicates a concentration of 31.8 $\mu\text{g/L}$.

13.2 Internal standard—calculate the concentration using the response factor determined from calibration data (Section 7.5) and the following equation:

Concentration = $(A_s \times C_{is}) / (A_{is} \times RF)$ where the terms are as defined in Section 7.5.1.

13.3 If the EICP area at the quantitation mass for any compound exceeds the calibration range of the system, the sample is diluted by successive factors of 10 and these dilutions are analyzed until the area is within the calibration range.

13.4 Report results for all pollutants and labeled compounds (Table 1) found in all standards, blanks, and samples, in µg/L to three significant figures. Results for samples which have been diluted are reported at the least dilute level at which the area at the quantitation mass is within the calibration range (Section 13.3) and the labeled compound recovery is within the normal range for the Method (Section 14.2).

14. Analysis of Complex Samples

14.1 Untreated effluents and other samples frequently contain high levels (>1000 µg/L) of the compounds of interest and of interfering compounds. Some samples will foam excessively when purged; others will overload the trap/or GC column.

14.2 Dilute 0.5 mL of sample with 4.5 mL of reagent water and analyze this diluted sample when labeled compound recovery is outside the range given in Table 5. If the recovery remains outside of the range for this diluted sample, the aqueous performance standard shall be analyzed (Section 11) and calibration verified (Section 11.5). If the recovery for the labeled compound in the aqueous performance standard is outside the range given in Table 5, the analytical system is out of control. In this case, the instrument shall be repaired, the performance specifications in Section 11 shall be met, and the analysis of the undiluted sample shall be repeated. If the recovery for the aqueous performance standard is within the range given in Table 5, the method does not work on the sample being analyzed and the result may not be reported for regulatory compliance purposes.

14.3 Reverse search computer programs can misinterpret the spectrum of chromatographically unresolved pollutant and labeled compound pairs with overlapping spectra when a high level of the pollutant is present. Examine each chromatogram for

peaks greater than the height of the internal standard peaks. These peaks can obscure the compounds of interest.

15. Method Performance

15.1 The specifications for this method were taken from the inter-laboratory validation of EPA Method 624 (reference 9). Method 1624 has been shown to yield slightly better performance on treated effluents than Method 624. Additional method performance data can be found in Reference 10.

References

1. "Performance Tests for the Evaluation of Computerized Gas Chromatography/Mass Spectrometry Equipment and Laboratories," USEPA, EMSL/Cincinnati, OH 45268, EPA-600/4-80-025 (April 1980).
2. Bellar, T.A. and Lichtenberg, J.J., "Journal American Water Works Association," 66, 739 (1974).
3. Bellar, T.A. and Lichtenberg, J.J., "Semi-automated Headspace Analysis of Drinking Waters and Industrial Waters for Purgeable Volatile Organic Compounds," in *Measurement of Organic Pollutants Water and Wastewater*, C.E. VanHall, ed., American Society for Testing Materials, Philadelphia, PA, Special Technical Publication 686, (1978).
4. "Working with Carcinogens," DHEW, PHS, NIOSH, Publication 77-206 (1977).
5. "OSHA Safety and Health Standards, General Industry," 29 CFR part 1910, OSHA 2206, (1976).
6. "Safety in Academic Chemistry Laboratories," American Chemical Society Publication, Committee on Chemical Safety (1979).
7. "Handbook of Analytical Quality Control in Water and Wastewater Laboratories," USEPA, EMSL/Cincinnati, OH 45268, EPA-4-79-019 (March 1979).
8. "Methods 330.4 and 330.5 for Total Residual Chlorine," USEPA, EMSL/Cincinnati, OH 45268, EPA-4-79-020 (March 1979).
9. "EPA Method Study 29 EPA Method 624—Purgeables," EPA 600/4-84-054, National Technical Information Service, PB84-209915, Springfield, Virginia 22161, June 1984.
10. "Colby, B.N., Beimer, R.G., Rushneck, D.R., and Telliard, W.A., "Isotope Dilution Gas Chromatography-Mass Spectrometry for the Determination of Priority Pollutants in Industrial Effluents," USEPA, Effluent Guidelines Division, Washington, DC 20460 (1980).

TABLE 1—VOLATILE ORGANIC COMPOUNDS ANALYZED BY ISOTOPE DILUTION GC/MS

| Compound | Storet | CAS registry | EPA-EGD | NPDES |
|----------------------------|--------|--------------|---------|-------|
| Acetone | 81552 | 67-64-1 | 516 V | |
| Acrolein | 34210 | 107-02-8 | 002 V | 001 V |
| Acrylonitrile | 34215 | 107-13-1 | 003 V | 002 V |
| Benzene | 34030 | 71-43-2 | 004 V | 003 V |
| Bromodichloromethane | 32101 | 75-27-4 | 048 V | 012 V |

TABLE 1—VOLATILE ORGANIC COMPOUNDS ANALYZED BY ISOTOPE DILUTION GC/MS—Continued

| Compound | Storet | CAS registry | EPA-EGD | NPDES |
|---------------------------|--------|--------------|---------|-------|
| Bromoform | 32104 | 75-25-2 | 047 V | 005 V |
| Bromomethane | 34413 | 74-83-9 | 046 V | 020 V |
| Carbon tetrachloride | 32102 | 56-23-5 | 006 V | 006 V |
| Chlorobenzene | 34301 | 108-90-7 | 007 V | 007 V |
| Chloroethane | 34311 | 75-00-3 | 016 V | 009 V |
| 2-chloroethylvinyl ether | 34576 | 110-75-8 | 019 V | 010 V |
| Chloroform | 32106 | 67-66-1 | 023 V | 011 V |
| Chloromethane | 34418 | 74-87-3 | 045 V | 021 V |
| Dibromochloromethane | 32105 | 124-48-1 | 051 V | 008 V |
| 1,1-dichloroethane | 34496 | 75-34-3 | 013 V | 014 V |
| 1,2-dichloroethane | 34536 | 107-06-2 | 010 V | 015 V |
| 1,1-dichloroethene | 34501 | 75-35-4 | 029 V | 016 V |
| Trans-1,2-dichloroethane | 34546 | 156-60-5 | 030 V | 026 V |
| 1,2-dichloropropane | 34541 | 78-87-5 | 032 V | 017 V |
| Cis-1,3-dichloropropene | 34704 | 10061-01-5 | | |
| Trans-1,3-dichloropropene | 34699 | 10061-02-6 | 033 V | |
| Diethyl ether | 81576 | 60-29-7 | 515 V | |
| P-dioxane | 81582 | 123-91-1 | 527 V | |
| Ethylbenzene | 34371 | 100-41-4 | 038 V | 019 V |
| Methylene chloride | 34423 | 75-09-2 | 044 V | 022 V |
| Methyl ethyl ketone | 81595 | 78-93-3 | 514 V | |
| 1,1,2,2-tetrachloroethane | 34516 | 79-34-5 | 015 V | 023 V |
| Tetrachlorethene | 34475 | 127-18-4 | 085 V | 024 V |
| Toluene | 34010 | 108-88-3 | 086 V | 025 V |
| 1,1,1-trichloroethane | 34506 | 71-55-6 | 011 V | 027 V |
| 1,1,2-trichloroethane | 34511 | 79-00-5 | 014 V | 028 V |
| Trichloroethene | 39180 | 79-01-6 | 087 V | 029 V |
| Vinyl chloride | 39175 | 75-01-4 | 088 V | 031 V |

TABLE 2—GAS CHROMATOGRAPHY OF PURGEABLE ORGANIC COMPOUNDS BY ISOTOPE DILUTION GC/MS

| EGD No. (1) | Compound | Ref EGD No. | Mean retention time (sec) | Minimum level (2) (ug/L) |
|-------------|-----------------------------|-------------|---------------------------|--------------------------|
| 181 | Bromochloromethane (I.S.) | 181 | 730 | 10 |
| 245 | Chloromethane-d3 | 181 | 147 | 50 |
| 345 | Chloromethane | 245 | 148 | 50 |
| 246 | Bromomethane-d3 | 181 | 243 | 50 |
| 346 | Bromomethane | 246 | 246 | 50 |
| 288 | Vinyl chloride-d3 | 181 | 301 | 50 |
| 388 | Vinyl chloride | 288 | 304 | 10 |
| 216 | Chloroethane-d5 | 181 | 378 | 50 |
| 316 | Chloroethane | 216 | 386 | 50 |
| 244 | Methylene chloride-d2 | 181 | 512 | 10 |
| 344 | Methylene chloride | 244 | 517 | 10 |
| 616 | Acetone-d6 | 181 | 554 | 50 |
| 716 | Acetone | 616 | 565 | 50 |
| 002 | Acrolein | 181 | 566 | 50 |
| 203 | Acrylonitrile-d3 | 181 | 606 | 50 |
| 303 | Acrylonitrile | 203 | 612 | 50 |
| 229 | 1,1-dichloroethene-d2 | 181 | 696 | 10 |
| 329 | 1,1-dichloroethene | 229 | 696 | 10 |
| 213 | 1,1-dichloroethene-d3 | 181 | 778 | 10 |
| 313 | 1,1-dichloroethane | 213 | 786 | 10 |
| 615 | Diethyl ether-d10 | 181 | 804 | 50 |
| 715 | Diethyl ether | 615 | 820 | 50 |
| 230 | Trans-1,2-dichloroethene-d2 | 181 | 821 | 10 |
| 330 | Trans-1,2-dichloroethene | 230 | 821 | 10 |
| 614 | Methyl ethyl ketone-d3 | 181 | 840 | 50 |
| 714 | Methyl ethyl ketone | 614 | 848 | 50 |
| 223 | Chloroform-13C1 | 181 | 861 | 10 |
| 323 | Chloroform | 223 | 861 | 10 |
| 210 | 1,2-dichloroethane-d4 | 181 | 901 | 10 |
| 310 | 1,2-dichloroethane | 210 | 910 | 10 |

TABLE 2—GAS CHROMATOGRAPHY OF PURGEABLE ORGANIC COMPOUNDS BY ISOTOPE DILUTION GC/MS—Continued

| EGD No. (1) | Compound | Ref EGD No. | Mean retention time (sec) | Minimum level (2) (ug/L) |
|-------------|--------------------------------|-------------|---------------------------|--------------------------|
| 211 | 1,1,1-trichloroethane-13C2 | 181 | 989 | 10 |
| 311 | 1,1,1-trichloroethane | 211 | 999 | 10 |
| 527 | p-dioxane | 181 | 1001 | 10 |
| 206 | Carbon tetrachloride-13C1 | 182 | 1018 | 10 |
| 306 | Carbon tetrachloride | 206 | 1018 | 10 |
| 248 | Bromodichloromethane-13C1 | 182 | 1045 | 10 |
| 348 | Bromodichloromethane | 248 | 1045 | 10 |
| 232 | 1,2-dichloropropane-d6 | 182 | 1123 | 10 |
| 332 | 1,2-dichloropropane | 232 | 1134 | 10 |
| 233 | Trans-1,3-dichloropropene-d4 | 182 | 1138 | 10 |
| 333 | Trans-1,3-dichloropropene | 233 | 1138 | 10 |
| 287 | Trichloroethene-13C1 | 182 | 1172 | 10 |
| 387 | Trichloroethene | 287 | 1187 | 10 |
| 204 | Benzene-d6 | 182 | 1200 | 10 |
| 304 | Benzene | 204 | 1212 | 10 |
| 251 | Chlorodibromomethane-13C1 | 182 | 1222 | 10 |
| 351 | Chlorodibromomethane | 251 | 1222 | 10 |
| 214 | 1,1,2-trichloroethane-13C2 | 182 | 1224 | 10 |
| 314 | 1,1,2-trichloroethane | 214 | 1224 | 10 |
| 019 | 2-chloroethylvinyl ether | 182 | 1278 | 10 |
| 182 | 2-bromo-1-chloropropane (I.S.) | 182 | 1306 | 10 |
| 247 | Bromoform-13C1 | 182 | 1386 | 10 |
| 347 | Bromoform | 247 | 1386 | 10 |
| 215 | 1,1,2,2-tetrachloroethane-d2 | 183 | 1525 | 10 |
| 315 | 1,1,2,2-tetrachloroethane | 215 | 1525 | 10 |
| 285 | Tetrachloroethene-13C2 | 183 | 1528 | 10 |
| 385 | Tetrachloroethene | 285 | 1528 | 10 |
| 183 | 1,4-dichlorobutane (int std) | 183 | 1555 | 10 |
| 286 | Toluene-d8 | 183 | 1603 | 10 |
| 386 | Toluene | 286 | 1619 | 10 |

Environmental Protection Agency

Pt. 136, App. A, Meth. 1624

TABLE 2—GAS CHROMATOGRAPHY OF PURGEABLE ORGANIC COMPOUNDS BY ISO-TOPE DILUTION GC/MS—Continued

| EGD No. (1) | Compound | Ref EGD No. | Mean retention time (sec) | Minimum level (2) (µg/L) |
|-------------|--------------------|-------------|---------------------------|--------------------------|
| 207 | Chlorobenzene-d5 | 183 | 1679 | 10 |
| 307 | Chlorobenzene | 207 | 1679 | 10 |
| 238 | Ethylbenzene-d10 | 183 | 1802 | 10 |
| 338 | Ethylbenzene | 238 | 1820 | 10 |
| 185 | Bromofluorobenzene | 183 | 1985 | 10 |

(1) Reference numbers beginning with 0, 1 or 5 indicate a pollutant quantified by the internal standard method; reference numbers beginning with 2 or 6 indicate a labeled compound quantified by the internal standard method; reference numbers beginning with 3 or 7 indicate a pollutant quantified by isotope dilution.

(2) This is a minimum level at which the analytical system shall give recognizable mass spectra (background corrected) and acceptable calibration points. Column: 2.4m (8 ft) x 2 mm i.d. glass, packed with one percent SP-1000 coated on 60/80 Carbowax B. Carrier gas: helium at 40 mL/min. Temperature program: 3 min at 45 °C, 8 °C per min to 240 °C, hold at 240 °C for 15 minutes.

NOTE: The specifications in this table were developed from data collected from three wastewater laboratories.

TABLE 3—BFB MASS-INTENSITY SPECIFICATIONS

| Mass | Intensity required |
|------|-------------------------------|
| 50 | 15 to 40 percent of mass 95. |
| 75 | 30 to 60 percent of mass 95. |
| 95 | base peak, 100 percent. |
| 96 | 5 to 9 percent of mass 95. |
| 173 | <2 percent of mass 174. |
| 174 | >50 percent of mass 95. |
| 175 | 5 to 9 percent of mass 174 |
| 176 | 95 to 101 percent of mass 174 |
| 177 | 5 to 9 percent of mass 176. |

TABLE 4—VOLATILE ORGANIC COMPOUND CHARACTERISTIC MASSES

| Labeled compound | Analog | Primary m/z's |
|---------------------------|--------|---------------|
| Acetone | d6 | 58/64 |
| Acrolein | d2 | 56/58 |
| Acrylonitrile | d3 | 53/56 |
| Benzene | d6 | 78/84 |
| Bromodichloromethane | 13C | 83/86 |
| Bromoform | 13C | 173/176 |
| Bromomethane | d3 | 96/99 |
| Carbon tetrachloride | 13C | 47/48 |
| Chlorobenzene | d5 | 112/117 |
| Chloroethane | d5 | 64/71 |
| 2-chloroethylvinyl ether | d7 | 106/113 |
| Chloroform | 13C | 85/86 |
| Chloromethane | d3 | 50/53 |
| Dibromochloromethane | 13C | 129/130 |
| 1,1-dichloroethane | d3 | 63/66 |
| 1,2-dichloroethane | d4 | 62/67 |
| 1,1-dichloroethene | d2 | 61/65 |
| Trans-1,2-dichloroethene | d2 | 61/65 |
| 1,2-dichloropropane | d6 | 63/67 |
| Cis-1,3-dichloropropene | d4 | 75/79 |
| Trans-1,3-dichloropropene | d4 | 75/79 |
| Diethyl ether | d10 | 74/84 |
| p-dioxane | d8 | 88/96 |
| Ethylbenzene | d10 | 106/116 |
| Methylene chloride | d2 | 84/88 |
| Methyl ethyl ketone | d3 | 72/75 |
| 1,1,2,2-tetrachloroethane | d2 | 83/84 |
| Tetrachloroethene | 13C2 | 166/172 |
| Toluene | d8 | 92/99 |
| 1,1,1-trichloroethane | d3 | 97/102 |
| 1,1,2-trichloroethane | 13C2 | 83/84 |
| Trichloroethene | 13C | 95/133 |
| Vinyl chloride | d3 | 62/65 |

TABLE 5—ACCEPTANCE CRITERIA FOR PERFORMANCE TESTS

| Compound | Acceptance criteria at 20 µg/L | | | |
|--------------------------|--|------------------|---|-----------------------------|
| | Initial precision and accuracy section 8.2.3 | | Labeled compound recovery sec. 8.3 and 14.2 | On-going accuracy sec. 11.5 |
| | s (µg/L) | \bar{X} (µg/L) | P (percent) | R (µg/L) |
| Acetone | | | Note 1 | |
| Acrolein | | | Note 2 | |
| Acrylonitrile | | | Note 2 | |
| Benzene | 9.0 | 13.0–28.2 | ns–196 | 4–33 |
| Bromodichloromethane | 8.2 | 6.5–31.5 | ns–199 | 4–34 |
| Bromoform | 7.0 | 7.4–35.1 | ns–214 | 6–36 |
| Bromomethane | 25.0 | d–54.3 | ns–414 | d–61 |
| Carbon tetrachloride | 6.9 | 15.9–24.8 | 42–165 | 12–30 |
| Chlorobenzene | 8.2 | 14.2–29.6 | ns–205 | 4–35 |
| Chloroethane | 14.8 | 2.1–46.7 | ns–308 | d–51 |
| 2-chloroethylvinyl ether | 36.0 | d–69.8 | ns–554 | d–79 |
| Chloroform | 7.9 | 11.6–26.3 | 18–172 | 8–30 |
| Chloromethane | 26.0 | d–55.5 | ns–410 | d–64 |
| Dibromochloromethane | 7.9 | 11.2–29.1 | 16–185 | 8–32 |
| 1,1-dichloroethane | 6.7 | 11.4–31.4 | 23–191 | 9–33 |
| 1,2-dichloroethane | 7.7 | 11.6–30.1 | 12–192 | 8–33 |
| 1,1-dichloroethene | 11.7 | d–49.8 | ns–315 | d–52 |
| Trans-1,2-dichloroethene | 7.4 | 10.5–31.5 | 15–195 | 8–34 |

TABLE 5—ACCEPTANCE CRITERIA FOR PERFORMANCE TESTS—Continued

| Compound | Acceptance criteria at 20 µg/L | | | |
|---------------------------------|---|------------------|---|-----------------------------------|
| | Initial precision and accuracy section 8.2.3 | | Labeled compound recovery sec. 8.3 and 14.2 | On-going accuracy sec. 11.5 |
| | s (µg/L) | \bar{X} (µg/L) | P (percent) | R (µg/L) |
| 1,2-dichloropropane | 19.2 | d-46.8 | ns-343 | d-51 |
| Cis-1,3-dichloropropene | 22.1 | d-51.0 | ns-381 | d-56 |
| Trans-1,3-dichloropropene | 14.5 | d-40.2 | ns-284 | d-44 |
| Diethyl ether | | Note 1 | | |
| P-dioxane | | Note 1 | | |
| Ethyl benzene | 9.6 | 15.6-28.5 | ns-203 | 5-35 |
| Methylene chloride | 9.7 | d-49.8 | ns-316 | d-50 |
| Methyl ethyl ketone | | Note 1 | | |
| 1,1,2,2-tetrachloroethane | 9.6 | 10.7-30.0 | 5-199 | 7-34 |
| Tetrachloroethene | 6.6 | 15.1-28.5 | 31-181 | 11-32 |
| Toluene | 6.3 | 14.5-28.7 | 4-193 | 6-33 |
| 1,1,1-trichloroethane | 5.9 | 10.5-33.4 | 12-200 | 8-35 |
| 1,1,2-trichloroethane | 7.1 | 11.8-29.7 | 21-184 | 9-32 |
| Trichloroethene | 8.9 | 16.6-29.5 | 35-196 | 12-34 |
| Vinyl chloride | 27.9 | d-58.5 | ns-452 | d-65 |

d = detected; result must be greater than zero.

ns = no specification; limit would be below detection limit.

NOTE 1: Specifications not available for these compounds at time of release of this method.

NOTE 2: Specifications not developed for these compounds; use method 603.

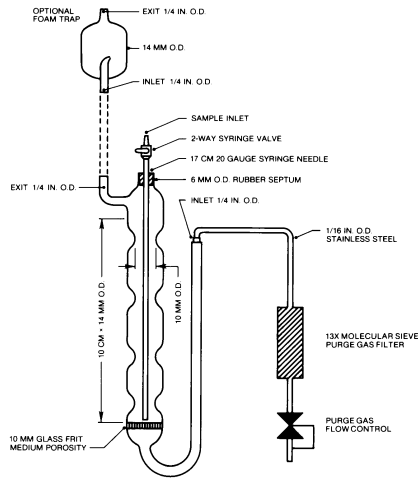

FIGURE 1 Purging Device.

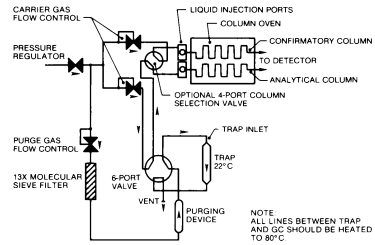

FIGURE 3 Schematic of Purge and Trap Device—Purge Mode.

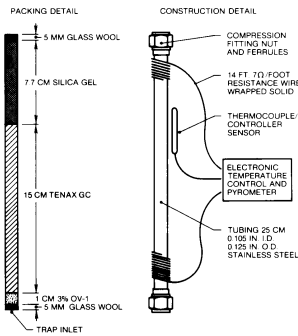

FIGURE 2 Trap Packings and Construction to Include Desorb Capability.

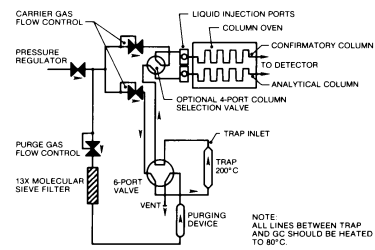

FIGURE 4 Schematic of Purge and Trap Device—Desorb Mode.

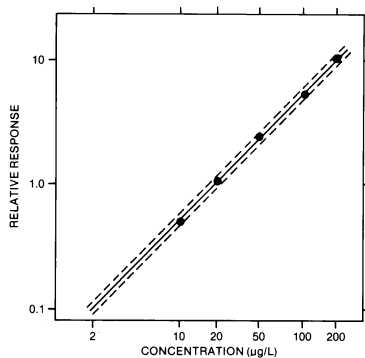

FIGURE 5 Relative Response Calibration Curve for Toluene. The Dotted Lines Enclose a ± 10 Percent Error Window.

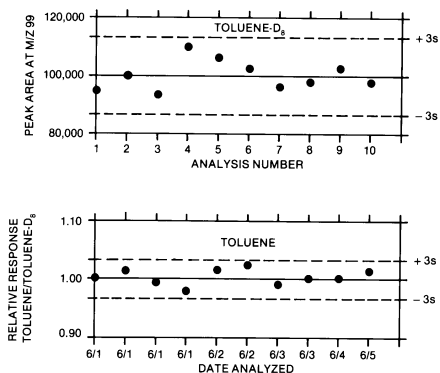

FIGURE 7 Quality Control Charts Showing Area (top graph) and Relative Response of Toluene to Toluene- d_8 (lower graph) Plotted as a Function of Time or Analysis Number.

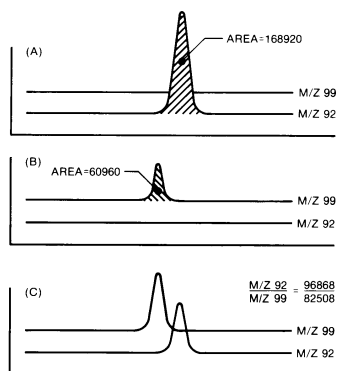

FIGURE 6 Extracted Ion Current Profiles for (A) Toluene, (B) Toluene- d_8 , and a Mixture of Toluene and Toluene- d_8 .

METHOD 1625 REVISION B—SEMIVOLATILE ORGANIC COMPOUNDS BY ISOTOPE DILUTION GC/MS

1. Scope and Application

1.1 This method is designed to determine the semivolatile toxic organic pollutants associated with the 1976 Consent Decree and

additional compounds amenable to extraction and analysis by capillary column gas chromatography-mass spectrometry (GC/MS).

1.2 The chemical compounds listed in Tables 1 and 2 may be determined in municipal and industrial discharges by this method. The method is designed to meet the survey

requirements of Effluent Guidelines Division (EGD) and the National Pollutants Discharge Elimination System (NPDES) under 40 CFR 136.1. Any modifications of this method, beyond those expressly permitted, shall be considered as major modifications subject to application and approval of alternate test procedures under 40 CFR 136.4 and 136.5.

1.3 The detection limit of this method is usually dependent on the level of interferences rather than instrumental limitations. The limits listed in Tables 3 and 4 represent the minimum quantity that can be detected with no interferences present.

1.4 The GC/MS portions of this method are for use only by analysts experienced with GC/MS or under the close supervision of such qualified persons. Laboratories unfamiliar with analyses of environmental samples by GC/MS should run the performance tests in reference 1 before beginning.

2. Summary of Method

2.1 Stable isotopically labeled analogs of the compounds of interest are added to a one liter wastewater sample. The sample is extracted at pH 12-13, then at pH <2 with methylene chloride using continuous extraction techniques. The extract is dried over sodium sulfate and concentrated to a volume of one mL. An internal standard is added to the extract, and the extract is injected into the gas chromatograph (GC). The compounds are separated by GC and detected by a mass spectrometer (MS). The labeled compounds serve to correct the variability of the analytical technique.

2.2 Identification of a compound (qualitative analysis) is performed by comparing the GC retention time and background corrected characteristic spectral masses with those of authentic standards.

2.3 Quantitative analysis is performed by GC/MS using extracted ion current profile (EICP) areas. Isotope dilution is used when labeled compounds are available; otherwise, an internal standard method is used.

2.4 Quality is assured through reproducible calibration and testing of the extraction and GC/MS systems.

3. Contamination and Interferences

3.1 Solvents, reagents, glassware, and other sample processing hardware may yield artifacts and/or elevated baselines causing misinterpretation of chromatograms and spectra. All materials shall be demonstrated to be free from interferences under the conditions of analysis by running method blanks initially and with each sample lot (samples started through the extraction process on a given 8 hr shift, to a maximum of 20). Specific selection of reagents and purification of solvents by distillation in all-glass systems may be required. Glassware and, where pos-

sible, reagents are cleaned by solvent rinse and baking at 450 °C for one hour minimum.

3.2 Interferences coextracted from samples will vary considerably from source to source, depending on the diversity of the industrial complex or municipality being samples.

4. Safety

4.1 The toxicity or carcinogenicity of each compound or reagent used in this method has not been precisely determined; however, each chemical compound should be treated as a potential health hazard. Exposure to these compounds should be reduced to the lowest possible level. The laboratory is responsible for maintaining a current awareness file of OSHA regulations regarding the safe handling of the chemicals specified in this method. A reference file of data handling sheets should also be made available to all personnel involved in these analyses. Additional information on laboratory safety can be found in references 2-4.

4.2 The following compounds covered by this method have been tentatively classified as known or suspected human or mammalian carcinogens: benzidine, benzo(a)anthracene, 3,3'-dichlorobenzidine, benzo(a)pyrene, dibenzo(a,h)anthracene, N-nitrosodimethylamine, and β -naphthylamine. Primary standards of these compounds shall be prepared in a hood, and a NIOSH/MESA approved toxic gas respirator should be worn when high concentrations are handled.

5. Apparatus and Materials

5.1 Sampling equipment for discrete or composite sampling.

5.1.1 Sample bottle, amber glass, 1.1 liters minimum. If amber bottles are not available, samples shall be protected from light. Bottles are detergent water washed, then solvent rinsed or baked at 450 °C for one hour minimum before use.

5.1.2 Bottle caps—threaded to fit sample bottles. Caps are lined with Teflon. Aluminum foil may be substituted if the sample is not corrosive. Liners are detergent water washed, then reagent water (Section 6.5) and solvent rinsed, and baked at approximately 200 °C for one hour minimum before use.

5.1.3 Compositing equipment—automatic or manual compositing system incorporating glass containers for collection of a minimum 1.1 liters. Sample containers are kept at 0 to 4 °C during sampling. Glass or Teflon tubing only shall be used. If the sampler uses a peristaltic pump, a minimum length of compressible silicone rubber tubing may be used in the pump only. Before use, the tubing is thoroughly rinsed with methanol, followed by repeated rinsings with reagent water (Section 6.5) to minimize sample contamination. An integrating flow meter is used to collect proportional composite samples.

5.2 Continuous liquid-liquid extractor—Teflon or glass connecting joints and stopcocks without lubrication (Hershberg-Wolf Extractor) one liter capacity, Ace Glass 6841-10, or equivalent.

5.3 Drying column—15 to 20 mm i.d. Pyrex chromatographic column equipped with coarse glass frit or glass wool plug.

5.4 Kuderna-Danish (K-D) apparatus

5.4.1 Concentrator tube—10mL, graduated (Kontes K-570050-1025, or equivalent) with calibration verified. Ground glass stopper (size 19/22 joint) is used to prevent evaporation of extracts.

5.4.2 Evaporation flask—500 mL (Kontes K-570001-0500, or equivalent), attached to concentrator tube with springs (Kontes K-662750-0012).

5.4.3 Snyder column—three ball macro (Kontes K-503000-0232, or equivalent).

5.4.4 Snyder column—two ball micro (Kontes K-469002-0219, or equivalent).

5.4.5 Boiling chips—approx 10/40 mesh, extracted with methylene chloride and baked at 450 °C for one hr minimum.

5.5 Water bath—heated, with concentric ring cover, capable of temperature control ± 2 °C, installed in a fume hood.

5.6 Sample vials—amber glass, 2-5 mL with Teflon-lined screw cap.

5.7 Analytical balance—capable of weighing 0.1 mg.

5.8 Gas chromatograph—shall have splitless or on-column injection port for capillary column, temperature program with 30 °C hold, and shall meet all of the performance specifications in Section 12.

5.8.1 Column—30 ± 5 m \times 0.25 \pm 0.02 mm i.d. 5% phenyl, 94% methyl, 1% vinyl silicone bonded phase fused silica capillary column (J & W DB-5, or equivalent).

5.9 Mass spectrometer—70 eV electron impact ionization, shall repetitively scan from 35 to 450 amu in 0.95 to 1.00 second, and shall produce a unit resolution (valleys between m/z 441-442 less than 10 percent of the height of the 441 peak), background corrected mass spectrum from 50 ng decafluorotriphenylphosphine (DFTPP) introduced through the GC inlet. The spectrum shall meet the mass-intensity criteria in Table 5 (reference 5). The mass spectrometer shall be interfaced to the GC such that the end of the capillary column terminates within one centimeter of the ion source but does not intercept the electron or ion beams. All portions of the column which connect the GC to the ion source shall remain at or above the column temperature during analysis to preclude condensation of less volatile compounds.

5.10 Data system—shall collect and record MS data, store mass-intensity data in spectral libraries, process GC/MS data, generate reports, and shall compute and record response factors.

5.10.1 Data acquisition—mass spectra shall be collected continuously throughout the analysis and stored on a mass storage device.

5.10.2 Mass spectral libraries—user created libraries containing mass spectra obtained from analysis of authentic standards shall be employed to reverse search GC/MS runs for the compounds of interest (Section 7.2).

5.10.3 Data processing—the data system shall be used to search, locate, identify, and quantify the compounds of interest in each GC/MS analysis. Software routines shall be employed to compute retention times and peak areas. Displays of spectra, mass chromatograms, and library comparisons are required to verify results.

5.10.4 Response factors and multipoint calibrations—the data system shall be used to record and maintain lists of response factors (response ratios for isotope dilution) and multipoint calibration curves (Section 7). Computations of relative standard deviation (coefficient of variation) are useful for testing calibration linearity. Statistics on initial (Section 8.2) and on-going (Section 12.7) performance shall be computed and maintained.

6. Reagents and Standards

6.1 Sodium hydroxide—reagent grade, 6N in reagent water.

6.2 Sulfuric acid—reagent grade, 6N in reagent water.

6.3 Sodium sulfate—reagent grade, granular anhydrous, rinsed with methylene chloride (20 mL/g) and conditioned at 450 °C for one hour minimum.

6.4 Methylene chloride—distilled in glass (Burdick and Jackson, or equivalent).

6.5 Reagent water—water in which the compounds of interest and interfering compounds are not detected by this method.

6.6 Standard solutions—purchased as solutions or mixtures with certification to their purity, concentration, and authenticity, or prepared from materials of known purity and composition. If compound purity is 96 percent or greater, the weight may be used without correction to compute the concentration of the standard. When not being used, standards are stored in the dark at -20 to -10 °C in screw-capped vials with Teflon-lined lids. A mark is placed on the vial at the level of the solution so that solvent evaporation loss can be detected. The vials are brought to room temperature prior to use. Any precipitate is redissolved and solvent is added if solvent loss has occurred.

6.7 Preparation of stock solutions—prepare in methylene chloride, benzene, p-dioxane, or a mixture of these solvents per the steps below. Observe the safety precautions in Section 4. The large number of labeled and unlabeled acid, base/neutral, and Appendix C compounds used for combined

calibration (Section 7) and calibration verification (12.5) require high concentrations (approx 40 mg/mL) when individual stock solutions are prepared, so that dilutions of mixtures will permit calibration with all compounds in a single set of solutions. The working range for most compounds is 10–200 µg/mL. Compounds with a reduced MS response may be prepared at higher concentrations.

6.7.1 Dissolve an appropriate amount of assayed reference material in a suitable solvent. For example, weigh 400 mg naphthalene in a 10 mL ground glass stoppered volumetric flask and fill to the mark with benzene. After the naphthalene is completely dissolved, transfer the solution to a 15 mL vial with Teflon-lined cap.

6.7.2 Stock standard solutions should be checked for signs of degradation prior to the preparation of calibration or performance test standards. Quality control check samples that can be used to determine the accuracy of calibration standards are available from the US Environmental Protection Agency, Environmental Monitoring and Support Laboratory, Cincinnati, Ohio 45268.

6.7.3 Stock standard solutions shall be replaced after six months, or sooner if comparison with quality control check samples indicates a change in concentration.

6.8 Labeled compound spiking solution— from stock standard solutions prepared as above, or from mixtures, prepare the spiking solution at a concentration of 200 µg/mL, or at a concentration appropriate to the MS response of each compound.

6.9 Secondary standard—using stock solutions (Section 6.7), prepare a secondary standard containing all of the compounds in Tables 1 and 2 at a concentration of 400 µg/mL, or higher concentration appropriate to the MS response of the compound.

6.10 Internal standard solution—prepare 2,2'-difluorobiphenyl (DFB) at a concentration of 10 mg/mL in benzene.

6.11 DFTPP solution—prepare at 50 µg/mL in acetone.

6.12 Solutions for obtaining authentic mass spectra (Section 7.2)—prepare mixtures of compounds at concentrations which will assure authentic spectra are obtained for storage in libraries.

6.13 Calibration solutions—combine 0.5 mL of the solution in Section 6.8 with 25, 50, 125, 250, and 500 µL of the solution in section 6.9 and bring to 1.00 mL total volume each. This will produce calibration solutions of nominal 10, 20, 50, 100, and 200 µg/mL of the pollutants and a constant nominal 100 µg/mL of the labeled compounds. Spike each solution with 10 µL of the internal standard solution (Section 6.10). These solutions permit the relative response (labeled to unlabeled) to be measured as a function of concentration (Section 7.4).

6.14 Precision and recovery standard—used for determination of initial (Section 8.2) and on-going (Section 12.7) precision and recovery. This solution shall contain the pollutants and labeled compounds at a nominal concentration of 100 µg/mL.

6.15 Stability of solutions—all standard solutions (Sections 6.8–6.14) shall be analyzed within 48 hours of preparation and on a monthly basis thereafter for signs of degradation. Standards will remain acceptable if the peak area at the quantitation mass relative to the DFB internal standard remains within ±15 percent of the area obtained in the initial analysis of the standard.

7. Calibration

7.1 Assemble the GC/MS and establish the operating conditions in Table 3. Analyze standards per the procedure in Section 11 to demonstrate that the analytical system meets the detection limits in Tables 3 and 4, and the mass-intensity criteria in Table 5 for 50 ng DFTPP.

7.2 Mass spectral libraries—detection and identification of compounds of interest are dependent upon spectra stored in user created libraries.

7.2.1 Obtain a mass spectrum of each pollutant, labeled compound, and the internal standard by analyzing an authentic standard either singly or as part of a mixture in which there is no interference between closely eluted components. That only a single compound is present is determined by examination of the spectrum. Fragments not attributable to the compound under study indicate the presence of an interfering compound.

7.2.2 Adjust the analytical conditions and scan rate (for this test only) to produce an undistorted spectrum at the GC peak maximum. An undistorted spectrum will usually be obtained if five complete spectra are collected across the upper half of the GC peak. Software algorithms designed to “enhance” the spectrum may eliminate distortion, but may also eliminate authentic masses or introduce other distortion.

7.2.3 The authentic reference spectrum is obtained under DFTPP tuning conditions (Section 7.1 and Table 5) to normalize it to spectra from other instruments.

7.2.4 The spectrum is edited by saving the 5 most intense mass spectral peaks and all other mass spectral peaks greater than 10 percent of the base peak. This edited spectrum is stored for reverse search and for compound confirmation.

7.3 Analytical range—demonstrate that 20 ng anthracene or phenanthrene produces an area at m/z 178 approx one-tenth that required to exceed the linear range of the system. The exact value must be determined by experience for each instrument. It is used to match the calibration range of the instrument to the analytical range and detection limits required, and to diagnose instrument

sensitivity problems (Section 15.4). The 20 µg/mL calibration standard (Section 6.13) can be used to demonstrate this performance.

7.3.1 Polar compound detection—demonstrate that unlabeled pentachlorophenol and benzidine are detectable at the 50 µg/mL level (per all criteria in Section 13). The 50 µg/mL calibration standard (Section 6.13) can be used to demonstrate this performance.

7.4 Calibration with isotope dilution—iso-
tope dilution is used when (1) labeled compounds are available, (2) interferences do not preclude its use, and (3) the quantitation mass extracted ion current profile (EICP) area for the compound is in the calibration range. If any of these conditions preclude isotope dilution, internal standard methods (Section 7.5 or 7.6) are used.

7.4.1 A calibration curve encompassing the concentration range is prepared for each compound to be determined. The relative response (pollutant to labeled) vs concentration in standard solutions is plotted or computed using a linear regression. The example in Figure 1 shows a calibration curve for phenol using phenol-d5 as the isotopic diluent. Also shown are the ±10 percent error limits (dotted lines). Relative Response (RR) is determined according to the procedures described below. A minimum of five data points are employed for calibration.

7.4.2 The relative response of a pollutant to its labeled analog is determined from isotope ratio values computed from acquired data. Three isotope ratios are used in this process:

R_x = the isotope ratio measured for the pure pollutant.

R_y = the isotope ratio measured for the labeled compound.

R_m = the isotope ratio of an analytical mixture of pollutant and labeled compounds.

The m/z's are selected such that $R_x > R_y$. If R_m is not between $2R_y$ and $0.5R_x$, the method does not apply and the sample is analyzed by internal or external standard methods.

7.4.3 Capillary columns usually separate the pollutant-labeled pair, with the labeled compound eluted first (Figure 2). For this case, $R_x = [\text{area } m_1/z]/1$, at the retention time of the pollutant (RT_2). $R_y = 1/[\text{area } m_2/z]$, at the retention time of the labeled compound (RT_1). $R_m = [\text{area at } m_1/z \text{ (at } RT_2)]/[\text{area at } RT_1]$, as measured in the mixture of the pollutant and labeled compounds (Figure 2), and $RR = R_m$.

7.4.4 Special precautions are taken when the pollutant-labeled pair is not separated, or when another labeled compound with interfering spectral masses overlaps the pollutant (a case which can occur with isomeric compounds). In this case, it is necessary to determine the respective contributions of the pollutant and labeled compounds to the respective EICP areas. If the peaks are separated well enough to permit the data system

or operator to remove the contributions of the compounds to each other, the equations in Section 7.4.3 apply. This usually occurs when the height of the valley between the two GC peaks at the same m/z is less than 10 percent of the height of the shorter of the two peaks. If significant GC and spectral overlap occur, RR is computed using the following equation:

$$RR = (R_y - R_m)(R_x + 1)/(R_m - R_x)(R_y + 1),$$

where R_x is measured as shown in Figure 3A, R_y is measured as shown in Figure 3B, and R_m is measured as shown in Figure 3C. For example, $R_x = 46100/4780 = 9.644$, $R_y = 2650/43600 = 0.0608$, $R_m = 49200/48300 = 1.019$, and $RR = 1.114$.

7.4.5 To calibrate the analytical system by isotope dilution, analyze a 1.0 µL aliquot of each of the calibration standards (Section 6.13) using the procedure in Section 11. Compute the RR at each concentration.

7.4.6 Linearity—if the ratio of relative response to concentration for any compound is constant (less than 20 percent coefficient of variation) over the 5 point calibration range, and averaged relative response/concentration ratio may be used for that compound; otherwise, the complete calibration curve for that compound shall be used over the 5 point calibration range.

7.5 Calibration by internal standard—used when criteria for isotope dilution (Section 7.4) cannot be met. The internal standard to be used for both acid and base/neutral analyses is 2,2'-difluorobiphenyl. The internal standard method is also applied to determination of compounds having no labeled analog, and to measurement of labeled compounds for intra-laboratory statistics (Sections 8.4 and 12.7.4).

7.5.1 Response factors—calibration requires the determination of response factors (RF) which are defined by the following equation:

$$RF = (A_s \times C_{is}) / (A_{is} \times C_s), \text{ where}$$

A_s is the area of the characteristic mass for the compound in the daily standard

A_{is} is the area of the characteristic mass for the internal standard

C_{is} is the concentration of the internal standard (µg/mL)

C_s is the concentration of the compound in the daily standard (µg/mL)

7.5.1.1 The response factor is determined for at least five concentrations appropriate to the response of each compound (Section 6.13); nominally, 10, 20, 50, 100, and 200 µg/mL. The amount of internal standard added to each extract is the same (100 µg/mL) so that C_{is} remains constant. The RF is plotted vs concentration for each compound in the standard (C_s) to produce a calibration curve.

7.5.1.2 Linearity—if the response factor (RF) for any compound is constant (less than 35 percent coefficient of variation) over the 5

point calibration range, an averaged response factor may be used for that compound; otherwise, the complete calibration curve for that compound shall be used over the 5 point range.

7.6 Combined calibration—by using calibration solutions (Section 6.13) containing the pollutants, labeled compounds, and the internal standard, a single set of analyses can be used to produce calibration curves for the isotope dilution and internal standard methods. These curves are verified each shift (Section 12.5) by analyzing the 100 µg/mL calibration standard (Section 6.13). Recalibration is required only if calibration verification (Section 12.5) criteria cannot be met.

8. Quality Assurance/Quality Control

8.1 Each laboratory that uses this method is required to operate a formal quality assurance program. The minimum requirements of this program consist of an initial demonstration of laboratory capability, analysis of samples spiked with labeled compounds to evaluate and document data quality, and analysis of standards and blanks as tests of continued performance. Laboratory performance is compared to established performance criteria to determine if the results of analyses meet the performance characteristics of the method.

8.1.1 The analyst shall make an initial demonstration of the ability to generate acceptable accuracy and precision with this method. This ability is established as described in Section 8.2.

8.1.2 The analyst is permitted to modify this method to improve separations or lower the costs of measurements, provided all performance specifications are met. Each time a modification is made to the method, the analyst is required to repeat the procedure in Section 8.2 to demonstrate method performance.

8.1.3 Analyses of blanks are required to demonstrate freedom from contamination. The procedures and criteria for analysis of a blank are described in Section 8.5.

8.1.4 The laboratory shall spike all samples with labeled compounds to monitor method performance. This test is described in Section 8.3. When results of these spikes indicate atypical method performance for samples, the samples are diluted to bring method performance within acceptable limits (Section 15).

8.1.5 The laboratory shall, on an on-going basis, demonstrate through calibration verification and the analysis of the precision and recovery standard (Section 6.14) that the analysis system is in control. These procedures are described in Sections 12.1, 12.5, and 12.7.

8.1.6 The laboratory shall maintain records to define the quality of data that is

generated. Development of accuracy statements is described in Section 8.4.

8.2 Initial precision and accuracy—to establish the ability to generate acceptable precision and accuracy, the analyst shall perform the following operations:

8.2.1 Extract, concentrate, and analyze two sets of four one-liter aliquots (8 aliquots total) of the precision and recovery standard (Section 6.14) according to the procedure in Section 10.

8.2.2 Using results of the first set of four analyses, compute the average recovery (\bar{X}) in µg/mL and the standard deviation of the recovery (s) in µg/mL for each compound, by isotope dilution for pollutants with a labeled analog, and by internal standard for labeled compounds and pollutants with no labeled analog.

8.2.3 For each compound, compare s and \bar{X} with the corresponding limits for initial precision and accuracy in Table 8. If s and \bar{X} for all compounds meet the acceptance criteria, system performance is acceptable and analysis of blanks and samples may begin. If, however, any individual s exceeds the precision limit or any individual \bar{X} falls outside the range for accuracy, system performance is unacceptable for that compound.

NOTE: The large number of compounds in Table 8 present a substantial probability that one or more will fail the acceptance criteria when all compounds are analyzed. To determine if the analytical system is out of control, or if the failure can be attributed to probability, proceed as follows:

8.2.4 Using the results of the second set of four analyses, compute s and \bar{X} for only those compounds which failed the test of the first set of four analyses (Section 8.2.3). If these compounds now pass, system performance is acceptable for all compounds and analysis of blanks and samples may begin. If, however, any of the same compounds fail again, the analysis system is not performing properly for these compounds. In this event, correct the problem and repeat the entire test (Section 8.2.1).

8.3 The laboratory shall spike all samples with labeled compounds to assess method performance on the sample matrix.

8.3.1 Analyze each sample according to the method in Section 10.

8.3.2 Compute the percent recovery (P) of the labeled compounds using the internal standard method (Section 7.5).

8.3.3 Compare the labeled compound recovery for each compound with the corresponding limits in Table 8. If the recovery of any compounds falls outside its warning limit, method performance is unacceptable for that compound in that sample. Therefore, the sample is complex and is to be diluted and reanalyzed per Section 15.4.

8.4 As part of the QA program for the laboratory, method accuracy for wastewater samples shall be assessed and records shall

be maintained. After the analysis of five wastewater samples for which the labeled compounds pass the tests in Section 8.3, compute the average percent recovery (P) and the standard deviation of the percent recovery (s_p) for the labeled compounds only. Express the accuracy assessment as a percent recovery interval from $P-2s_p$ to $P+2s_p$. For example, if $P=90\%$ and $s_p=10\%$, the accuracy interval is expressed as 70–100%. Update the accuracy assessment for each compound on a regular basis (e.g. after each 5–10 new accuracy measurements).

8.5 Blanks—reagent water blanks are analyzed to demonstrate freedom from contamination.

8.5.1 Extract and concentrate a blank with each sample lot (samples started through the extraction process on the same 8 hr shift, to a maximum of 20 samples). Analyze the blank immediately after analysis of the precision and recovery standard (Section 6.14) to demonstrate freedom from contamination.

8.5.2 If any of the compounds of interest (Tables 1 and 2) or any potentially interfering compound is found in a blank at greater than 10 $\mu\text{g/L}$ (assuming a response factor of 1 relative to the internal standard for compounds not listed in Tables 1 and 2), analysis of samples is halted until the source of contamination is eliminated and a blank shows no evidence of contamination at this level.

8.6 The specifications contained in this method can be met if the apparatus used is calibrated properly, then maintained in a calibrated state. The standards used for calibration (Section 7), calibration verification (Section 12.5), and for initial (Section 8.2) and on-going (Section 12.7) precision and recovery should be identical, so that the most precise results will be obtained. The GC/MS instrument in particular will provide the most reproducible results if dedicated to the settings and conditions required for the analysis of semi-volatiles by this method.

8.7 Depending on specific program requirements, field replicates may be collected to determine the precision of the sampling technique, and spiked samples may be required to determine the accuracy of the analysis when internal or external standard methods are used.

9. Sample Collection, Preservation, and Handling

9.1 Collect samples in glass containers following conventional sampling practices (Reference 7). Composite samples are collected in refrigerated glass containers (Section 5.1.3) in accordance with the requirements of the sampling program.

9.2 Maintain samples at 0–4 °C from the time collection until extraction. If residual chlorine is present, add 80 mg sodium thiosulfate per liter of water. EPA Methods

330.4 and 330.5 may be used to measure residual chlorine (Reference 8).

9.3 Begin sample extraction within seven days of collection, and analyze all extracts within 40 days of extraction.

10. Sample Extraction and Concentration (See Figure 4)

10.1 Labeled compound spiking—measure 1.00 ± 0.01 liter of sample into a glass container. For untreated effluents, and samples which are expected to be difficult to extract and/or concentrate, measure an additional 10.0 ± 0.1 mL and dilute to a final volume of 1.00 ± 0.01 liter with reagent water in a glass container.

10.1.1 For each sample or sample lot (to a maximum of 20) to be extracted at the same time, place three 1.00 ± 0.10 liter aliquots of reagent water in glass containers.

10.1.2 Spike 0.5 mL of the labeled compound spiking solution (Section 6.8) into all samples and one reagent water aliquot.

10.1.3 Spike 1.0 mL of the precision and recovery standard (Section 6.14) into the two remaining reagent water aliquots.

10.1.4 Stir and equilibrate all solutions for 1–2 hr.

10.2 Base/neutral extraction—place 100–150 mL methylene chloride in each continuous extractor and 200–300 in each distilling flask.

10.2.1 Pour the sample(s), blank, and standard aliquots into the extractors. Rinse the glass containers with 50–100 mL methylene chloride and add to the respective extractor.

10.2.2 Adjust the pH of the waters in the extractors to 12–13 with 6N NaOH while monitoring with a pH meter. Begin the extraction by heating the flask until the methylene chloride is boiling. When properly adjusted, 1–2 drops of methylene chloride per second will fall from the condenser tip into the water. After 1–2 hours of extraction, test the pH and readjust to 12–13 if required. Extract for 18–24 hours.

10.2.3 Remove the distilling flask, estimate and record the volume of extract (to the nearest 100 mL), and pour the contents through a drying column containing 7 to 10 cm anhydrous sodium sulfate. Rinse the distilling flask with 30–50 mL of methylene chloride and pour through the drying column. Collect the solution in a 500 mL K-D evaporator flask equipped with a 10 mL concentrator tube. Seal, label as the base/neutral fraction, and concentrate per Sections 10.4 to 10.5.

10.3 Acid extraction—adjust the pH of the waters in the extractors to 2 or less using 6N sulfuric acid. Charge clean distilling flasks with 300–400 mL of methylene chloride. Test and adjust the pH of the waters after the first 1–2 hr of extraction. Extract for 18–24 hours.

10.3.1 Repeat Section 10.2.3, except label as the acid fraction.

10.4 Concentration—concentrate the extracts in separate 500 mL K-D flasks equipped with 10 mL concentrator tubes.

10.4.1 Add 1 to 2 clean boiling chips to the flask and attach a three-ball macro Snyder column. Prewet the column by adding approximately one mL of methylene chloride through the top. Place the K-D apparatus in a hot water bath so that the entire lower rounded surface of the flask is bathed with steam. Adjust the vertical position of the apparatus and the water temperature as required to complete the concentration in 15 to 20 minutes. At the proper rate of distillation, the balls of the column will actively chatter but the chambers will not flood. When the liquid has reached an apparent volume of 1 mL, remove the K-D apparatus from the bath and allow the solvent to drain and cool for at least 10 minutes. Remove the Snyder column and rinse the flask and its lower joint into the concentrator tube with 1–2 mL of methylene chloride. A 5-mL syringe is recommended for this operation.

10.4.2 For performance standards (Sections 8.2 and 12.7) and for blanks (Section 8.5), combine the acid and base/neutral extracts for each at this point. Do not combine the acid and base/neutral extracts for samples.

10.5 Add a clean boiling chip and attach a two ball micro Snyder column to the concentrator tube. Prewet the column by adding approx 0.5 mL methylene chloride through the top. Place the apparatus in the hot water bath. Adjust the vertical position and the water temperature as required to complete the concentration in 5–10 minutes. At the proper rate of distillation, the balls of the column will actively chatter but the chambers will not flood. When the liquid reaches an apparent volume of approx 0.5 mL, remove the apparatus from the water bath and allow to drain and cool for at least 10 minutes. Remove the micro Snyder column and rinse its lower joint into the concentrator tube with approx 0.2 mL of methylene chloride. Adjust the final volume to 1.0 mL.

10.6 Transfer the concentrated extract to a clean screw-cap vial. Seal the vial with a Teflon-lined lid, and mark the level on the vial. Label with the sample number and fraction, and store in the dark at -20 to -10 °C until ready for analysis.

11. GC/MS Analysis

11.1 Establish the operating conditions given in Table 3 or 4 for analysis of the base/neutral or acid extracts, respectively. For analysis of combined extracts (Section 10.4.2), use the operating conditions in Table 3.

11.2 Bring the concentrated extract (Section 10.6) or standard (Sections 6.13 through 6.14) to room temperature and verify that any precipitate has redissolved. Verify the level on the extract (Sections 6.6 and 10.6)

and bring to the mark with solvent if required.

11.3 Add the internal standard solution (Section 6.10) to the extract (use 1.0 μ L of solution per 0.1 mL of extract) immediately prior to injection to minimize the possibility of loss by evaporation, adsorption, or reaction. Mix thoroughly.

11.4 Inject a volume of the standard solution or extract such that 100 ng of the internal standard will be injected, using on-column or splitless injection. For 1 mL extracts, this volume will be 1.0 μ L. Start the GC column initial isothermal hold upon injection. Start MS data collection after the solvent peak elutes. Stop data collection after the benzo (ghi) perylene or pentachlorophenol peak elutes for the base/neutral or acid fraction, respectively. Return the column to the initial temperature for analysis of the next sample.

12. System and Laboratory Performance

12.1 At the beginning of each 8 hr shift during which analyses are performed, GC/MS system performance and calibration are verified for all pollutants and labeled compounds. For these tests, analysis of the 100 μ g/mL calibration standard (Section 6.13) shall be used to verify all performance criteria. Adjustment and/or recalibration (per Section 7) shall be performed until all performance criteria are met. Only after all performance criteria are met may samples, blanks, and precision and recovery standards be analyzed.

12.2 DFTPP spectrum validity—inject 1 μ L of the DFTPP solution (Section 6.11) either separately or within a few seconds of injection of the standard (Section 12.1) analyzed at the beginning of each shift. The criteria in Table 5 shall be met.

12.3 Retention times—the absolute retention time of 2,2'-difluorobiphenyl shall be within the range of 1078 to 1248 seconds and the relative retention times of all pollutants and labeled compounds shall fall within the limits given in Tables 3 and 4.

12.4 GC resolution—the valley height between anthracene and phenanthrene at m/z 178 (or the analogs at m/z 188) shall not exceed 10 percent of the taller of the two peaks.

12.5 Calibration verification—compute the concentration of each pollutant (Tables 1 and 2) by isotope dilution (Section 7.4) for those compounds which have labeled analogs. Compute the concentration of each pollutant which has no labeled analog by the internal standard method (Section 7.5). Compute the concentration of the labeled compounds by the internal standard method. These concentrations are computed based on the calibration data determined in Section 7.

12.5.1 For each pollutant and labeled compound being tested, compare the concentration with the calibration verification limit

in Table 8. If all compounds meet the acceptance criteria, calibration has been verified and analysis of blanks, samples, and precision and recovery standards may proceed. If, however, any compound fails, the measurement system is not performing properly for that compound. In this event, prepare a fresh calibration standard or correct the problem causing the failure and repeat the test (Section 12.1), or recalibrate (Section 7).

12.6 Multiple peaks—each compound injected shall give a single, distinct GC peak.

12.7 On-going precision and accuracy.

12.7.1 Analyze the extract of one of the pair of precision and recovery standards (Section 10.1.3) prior to analysis of samples from the same lot.

12.7.2 Compute the concentration of each pollutant (Tables 1 and 2) by isotope dilution (Section 7.4) for those compounds which have labeled analogs. Compute the concentration of each pollutant which has no labeled analog by the internal standard method (Section 7.5). Compute the concentration of the labeled compounds by the internal standard method.

12.7.3 For each pollutant and labeled compound, compare the concentration with the limits for on-going accuracy in Table 8. If all compounds meet the acceptance criteria, system performance is acceptable and analysis of blanks and samples may proceed. If, however, any individual concentration falls outside of the range given, system performance is unacceptable for that compound.

NOTE: The large number of compounds in Table 8 present a substantial probability that one or more will fail when all compounds are analyzed. To determine if the extraction/concentration system is out of control or if the failure is caused by probability, proceed as follows:

12.7.3.1 Analyze the second aliquot of the pair of precision and recovery standard (Section 10.1.3).

12.7.3.2 Compute the concentration of only those pollutants or labeled compounds that failed the previous test (Section 12.7.3). If these compounds now pass, the extraction/concentration processes are in control and analysis of blanks and samples may proceed. If, however, any of the same compounds fail again, the extraction/concentration processes are not being performed properly for these compounds. In this event, correct the problem, re-extract the sample lot (Section 10) and repeat the on-going precision and recovery test (Section 12.7).

12.7.4 Add results which pass the specifications in Section 12.7.2 to initial and previous on-going data. Update QC charts to perform a graphic representation of continued laboratory performance (Figure 5). Develop a statement of laboratory accuracy for each pollutant and labeled compound by calculating the average percent recovery (R) and the standard deviation of percent recovery

(s_r). Express the accuracy as a recovery interval from $R-2s_r$ to $R+2s_r$. For example, if $R=95\%$ and $s_r=5\%$, the accuracy is 85–105%.

13. Qualitative Determination

13.1 Qualitative determination is accomplished by comparison of data from analysis of a sample or blank with data from analysis of the shift standard (Section 12.1) and with data stored in the spectral libraries (Section 7.2.4). Identification is confirmed when spectra and retention times agree per the criteria below.

13.2 Labeled compounds and pollutants having no labeled analog:

13.2.1 The signals for all characteristic masses stored in the spectral library (Section 7.2.4) shall be present and shall maximize within the same two consecutive scans.

13.2.2 Either (1) the background corrected EICP areas, or (2) the corrected relative intensities of the mass spectral peaks at the GC peak maximum shall agree within a factor of two (0.5 to 2 times) for all masses stored in the library.

13.2.3 The retention time relative to the nearest eluted internal standard shall be within ± 15 scans or ± 15 seconds, whichever is greater of this difference in the shift standard (Section 12.1).

13.3 Pollutants having a labeled analog:

13.3.1 The signals for all characteristic masses stored in the spectral library (Section 7.2.4) shall be present and shall maximize within the same two consecutive scans.

13.3.2 Either (1) the background corrected EICP areas, or (2) the corrected relative intensities of the mass spectral peaks at the GC peak maximum shall agree within a factor of two for all masses stored in the spectral library.

13.3.3 The retention time difference between the pollutant and its labeled analog shall agree within ± 6 scans or ± 6 seconds (whichever is greater) of this difference in the shift standard (Section 12.1).

13.4 Masses present in the experimental mass spectrum that are not present in the reference mass spectrum shall be accounted for by contaminant or background ions. If the experimental mass spectrum is contaminated, an experienced spectrometrist (Section 1.4) is to determine the presence or absence of the compound.

14. Quantitative Determination

14.1 Isotope dilution—by adding a known amount of a labeled compound to every sample prior to extraction, correction for recovery of the pollutant can be made because the pollutant and its labeled analog exhibit the same effects upon extraction, concentration, and gas chromatography. Relative response (RR) values for mixtures are used in conjunction with calibration curves described in

Section 7.4 to determine concentrations directly, so long as labeled compound spiking levels are constant. For the phenol example given in Figure 1 (Section 7.4.1), RR would be equal to 1.114. For this RR value, the phenol calibration curve given in Figure 1 indicates a concentration of 27 µg/mL in the sample extract (C_{ex}).

14.2 Internal standard—compute the concentration in the extract using the response factor determined from calibration data (Section 7.5) and the following equation: $C_{ex}(\mu\text{g/mL}) = (A_s \times C_{is}) / (A_{is} \times RF)$ where C_{ex} is the concentration of the compound in the extract, and the other terms are as defined in Section 7.5.1.

14.3 The concentration of the pollutant in water is computed using the volumes of the original water sample (Section 10.1) and the final extract volume (Section 10.5), as follows: Concentration in water ($\mu\text{g/L}$) = $(C_{ex} \times V_{ex}) / V_s$, where V_{ex} is the extract volume in mL, and V_s is the sample volume in liters.

14.4 If the EICP area at the quantitation mass for any compound exceeds the calibration range of the system, the extract of the dilute aliquot (Section 10.1) is analyzed by isotope dilution; otherwise, the extract is diluted by a factor of 10, 9 µL of internal standard solution (Section 6.10) are added to a 1.0 mL aliquot, and this diluted extract is analyzed by the internal standard method (Section 14.2). Quantify each compound at the highest concentration level within the calibration range.

14.5 Report results for all pollutants and labeled compounds (Tables 1 and 2) found in all standards, blanks, and samples in µg/L, to three significant figures. Results for samples which have been diluted are reported at the least dilute level at which the area at the quantitation mass is within the calibration range (Section 14.4) and the labeled compound recovery is within the normal range for the method (Section 15.4).

15. Analysis of Complex Samples

15.1 Untreated effluents and other samples frequently contain high levels (>1000 µg/L) of the compounds of interest, interfering compounds, and/or polymeric materials. Some samples will not concentrate to one mL (Section 10.5); others will overload the GC column and/or mass spectrometer.

15.2 Analyze the dilute aliquot (Section 10.1) when the sample will not concentrate to 1.0 mL. If a dilute aliquot was not extracted, and the sample holding time (Section 9.3) has not been exceeded, dilute an aliquot of the sample with reagent water and re-extract (Section 10.1); otherwise, dilute the extract (Section 14.4) and analyze by the internal standard method (Section 14.2).

15.3 Recovery of internal standard—the EICP area of the internal standard should be within a factor of two of the area in the shift standard (Section 12.1). If the absolute areas

of the labeled compounds are within a factor of two of the respective areas in the shift standard, and the internal standard area is less than one-half of its respective area, then internal standard loss in the extract has occurred. In this case, use one of the labeled compounds (preferably a polynuclear aromatic hydrocarbon) to compute the concentration of a pollutant with no labeled analog.

15.4 Recovery of labeled compounds—in most samples, labeled compound recoveries will be similar to those from reagent water (Section 12.7). If the labeled compound recovery is outside the limits given in Table 8, the dilute extract (Section 10.1) is analyzed as in Section 14.4. If the recoveries of all labeled compounds and the internal standard are low (per the criteria above), then a loss in instrument sensitivity is the most likely cause. In this case, the 100 µg/mL calibration standard (Section 12.1) shall be analyzed and calibration verified (Section 12.5). If a loss in sensitivity has occurred, the instrument shall be repaired, the performance specifications in Section 12 shall be met, and the extract re-analyzed. If a loss in instrument sensitivity has not occurred, the method does not work on the sample being analyzed and the result may not be reported for regulatory compliance purposes.

16. Method Performance

16.1 Interlaboratory performance for this method is detailed in references 9 and 10.

16.2 A chromatogram of the 100 µg/mL acid/base/neutral calibration standard (Section 6.13) is shown in Figure 6.

REFERENCES

1. "Performance Tests for the Evaluation of Computerized Gas Chromatography/Mass Spectrometry Equipment and Laboratories" USEPA, EMSL/Cincinnati, OH 45268, EPA-600/4-80-025 (April 1980).
2. "Working with Carcinogens," DHEW, PHS, CDC, NIOSH, Publication 77-206, (August 1977).
3. "OSHA Safety and Health Standards, General Industry" OSHA 2206, 29 CFR part 1910 (January 1976).
4. "Safety in Academic Chemistry Laboratories," ACS Committee on Chemical Safety (1979).
5. "Reference Compound to Calibrate Ion Abundance Measurement in Gas Chromatography-Mass Spectrometry Systems," J.W. Eichelberger, L.E. Harris, and W.L. Budde, *Anal. Chem.*, 47, 955 (1975).
6. "Handbook of Analytical Quality Control in Water and Wastewater Laboratories," USEPA, EMSL/Cincinnati, OH 45268, EPA-600/4-79-019 (March 1979).
7. "Standard Practice for Sampling Water," ASTM Annual Book of Standards, ASTM, Philadelphia, PA, 76 (1980).

8. "Methods 330.4 and 330.5 for Total Residual Chlorine," USEPA, EMSL/ Cincinnati, OH 45268, EPA 600/4-70-020 (March 1979).

9. Colby, B.N., Beimer, R.G., Rushneck, D.R., and Telliard, W.A., "Isotope Dilution Gas Chromatography-Mass Spectrometry for the determination of Priority Pollutants in

Industrial Effluents." USEPA, Effluent Guidelines Division, Washington, DC 20460 (1980).

10. "Inter-laboratory Validation of US Environmental Protection Agency Method 1625," USEPA, Effluent Guidelines Division, Washington, DC 20460 (June 15, 1984).

TABLE 1—BASE/NEUTRAL EXTRACTABLE COMPOUNDS

| Compound | STORET | CAS registry | EPA-EGD | NPDES |
|----------------------------------|--------|--------------|---------|-------|
| Acenaphthene | 34205 | 83-32-9 | 001 B | 001 B |
| Acenaphthylene | 34200 | 208-96-8 | 077 B | 002 B |
| Anthracene | 34220 | 120-12-7 | 078 B | 003 B |
| Benzidine | 39120 | 92-87-5 | 005 B | 004 B |
| Benzo(a)anthracene | 34526 | 56-55-3 | 072 B | 005 B |
| Benzo(b)fluoranthene | 34230 | 205-99-2 | 074 B | 007 B |
| Benzo(k)fluoranthene | 34242 | 207-08-9 | 075 B | 009 B |
| Benzo(a)pyrene | 34247 | 50-32-8 | 073 B | 006 B |
| Benzo(ghi)perylene | 34521 | 191-24-2 | 079 B | 008 B |
| Biphenyl (Appendix C) | 81513 | 92-52-4 | 512 B | |
| Bis(2-chloroethyl) ether | 34273 | 111-44-4 | 018 B | 011 B |
| Bis(2-chloroethoxy)methane | 34278 | 111-91-1 | 043 B | 010 B |
| Bis(2-chloroisopropyl) ether | 34283 | 108-60-1 | 042 B | 012 B |
| Bis(2-ethylhexyl) phthalate | 39100 | 117-81-7 | 066 B | 013 B |
| 4-bromophenyl phenyl ether | 34636 | 101-55-3 | 041 B | 014 B |
| Butyl benzyl phthalate | 34292 | 85-68-7 | 067 B | 015 B |
| n-C10 (Appendix C) | 77427 | 124-18-5 | 517 B | |
| n-C12 (Appendix C) | 77588 | 112-40-2 | 506 B | |
| n-C14 (Appendix C) | 77691 | 629-59-4 | 518 B | |
| n-C16 (Appendix C) | 77757 | 544-76-3 | 519 B | |
| n-C18 (Appendix C) | 77804 | 593-45-3 | 520 B | |
| n-C20 (Appendix C) | 77830 | 112-95-8 | 521 B | |
| n-C22 (Appendix C) | 77859 | 629-97-0 | 522 B | |
| n-C24 (Appendix C) | 77886 | 646-31-1 | 523 B | |
| n-C26 (Appendix C) | 77901 | 630-01-3 | 524 B | |
| n-C28 (Appendix C) | 78116 | 630-02-4 | 525 B | |
| n-C30 (Appendix C) | 78117 | 638-68-6 | 526 B | |
| Carbazole (4c) | 77571 | 86-74-8 | 528 B | |
| 2-chloronaphthalene | 34581 | 91-58-7 | 020 B | 016 B |
| 4-chlorophenyl phenyl ether | 34641 | 7005-72-3 | 040 B | 017 B |
| Chrysene | 34320 | 218-01-9 | 076 B | 018 B |
| P-cymene (Appendix C) | 77356 | 99-87-6 | 513 B | |
| Dibenzo(a,h)anthracene | 34556 | 53-70-3 | 082 B | 019 B |
| Dibenzofuran (Appendix C and 4c) | 81302 | 132-64-9 | 505 B | |
| Dibenzothiophene (Synfuel) | 77639 | 132-65-0 | 504 B | |
| Di-n-butyl phthalate | 39110 | 84-74-2 | 068 B | 026 B |
| 1,2-dichlorobenzene | 34536 | 95-50-1 | 025 B | 020 B |
| 1,3-dichlorobenzene | 34566 | 541-73-1 | 026 B | 021 B |
| 1,4-dichlorobenzene | 34571 | 106-46-7 | 027 B | 022 B |
| 3,3'-dichlorobenzidine | 34631 | 91-94-1 | 028 B | 023 B |
| Diethyl phthalate | 34336 | 84-66-2 | 070 B | 024 B |
| 2,4-dimethylphenol | 34606 | 105-67-9 | 034 A | 003 A |
| Dimethyl phthalate | 34341 | 131-11-3 | 071 B | 025 B |
| 2,4-dinitrotoluene | 34611 | 121-14-2 | 035 B | 027 B |
| 2,6-dinitrotoluene | 34626 | 606-20-2 | 036 B | 028 B |
| Di-n-octyl phthalate | 34596 | 117-84-0 | 069 B | 029 B |
| Diphenylamine (Appendix C) | 77579 | 122-39-4 | 507 B | |
| Diphenyl ether (Appendix C) | 77587 | 101-84-8 | 508 B | |
| 1,2-diphenylhydrazine | 34346 | 122-66-7 | 037 B | 030 B |
| Fluoranthene | 34376 | 206-44-0 | 039 B | 031 B |
| Fluorene | 34381 | 86-73-7 | 080 B | 032 B |
| Hexachlorobenzene | 39700 | 118-74-1 | 009 B | 033 B |
| Hexachlorobutadiene | 34391 | 87-68-3 | 052 B | 034 B |
| Hexachloroethane | 34396 | 67-72-1 | 012 B | 036 B |
| Hexachlorocyclopentadiene | 34386 | 77-47-4 | 053 B | 035 B |
| Indeno(1,2,3-cd)pyrene | 34403 | 193-39-5 | 083 B | 037 B |
| Isophorone | 34408 | 78-59-1 | 054 B | 038 B |
| Naphthalene | 34696 | 91-20-3 | 055 B | 039 B |
| B-naphthylamine (Appendix C) | 82553 | 91-59-8 | 502 B | |
| Nitrobenzene | 34447 | 98-95-3 | 056 B | 040 B |
| N-nitrosodimethylamine | 34438 | 62-75-9 | 061 B | 041 B |
| N-nitrosodi-n-propylamine | 34428 | 621-64-7 | 063 B | 042 B |
| N-nitrosodiphenylamine | 34433 | 86-30-3 | 062 B | 043 B |

TABLE 1—BASE/NEUTRAL EXTRACTABLE COMPOUNDS—Continued

| Compound | STORET | CAS registry | EPA-EGD | NPDES |
|-----------------------------------|--------|--------------|---------|-------|
| Phenanthrene | 34461 | 85-01-8 | 081 B | 044 B |
| Phenol | 34694 | 108-95-2 | 065 A | 010 A |
| a-Picoline (Synfuel) | 77088 | 109-06-89 | 503 B | |
| Pyrene | 34469 | 129-00-0 | 084 B | 045 B |
| styrene (Appendix C) | 77128 | 100-42-5 | 510 B | |
| a-terpineol (Appendix C) | 77493 | 98-55-5 | 509 B | |
| 1,2,3-trichlorobenzene (4c) | 77613 | 87-61-6 | 529 B | |
| 1,2,4-trichlorobenzene | 34551 | 120-82-1 | 008 B | 046 B |

TABLE 2—ACID EXTRACTABLE COMPOUNDS

| Compound | STORET | CAS registry | EPA-EGD | NPDES |
|----------------------------------|--------|--------------|---------|-------|
| 4-chloro-3-methylphenol | 34452 | 59-50-7 | 022 A | 008 A |
| 2-chlorophenol | 34586 | 95-57-8 | 024 A | 001 A |
| 2,4-dichlorophenol | 34601 | 120-83-2 | 031 A | 002 A |
| 2,4-dinitrophenol | 34616 | 51-28-5 | 059 A | 005 A |
| 2-methyl-4,6-dinitrophenol | 34657 | 534-52-1 | 060 A | 004 A |
| 2-nitrophenol | 34591 | 88-75-5 | 057 A | 006 A |
| 4-nitrophenol | 34646 | 100-02-7 | 058 A | 007 A |
| Pentachlorophenol | 39032 | 87-86-5 | 064 A | 009 A |
| 2,3,6-trichlorophenol (4c) | 77688 | 93-37-55 | 530 A | |
| 2,4,5-trichlorophenol (4c) | | 95-95-4 | 531 A | |
| 2,4,6-trichlorophenol | 34621 | 88-06-2 | 021 A | 011 A |

TABLE 3—GAS CHROMATOGRAPHY OF BASE/NEUTRAL EXTRACTABLE COMPOUNDS

| EGD No. 1 | Compound | Retention time | | | Detection limit ² (µg/L) |
|-----------|--|----------------|---------|-------------|-------------------------------------|
| | | Mean (sec) | EGD Ref | Relative | |
| 164 | 2,2'-difluorobiphenyl (int std) | 1163 | 164 | 1.000-1.000 | 10 |
| 061 | N-nitrosodimethylamine | 385 | 164 | ns | 50 |
| 603 | alpha picoline-d7 | 417 | 164 | 0.326-0.393 | 50 |
| 703 | alpha picoline | 426 | 603 | 1.006-1.028 | 50 |
| 610 | styrene-d5 | 546 | 164 | 0.450-0.488 | 10 |
| 710 | styrene | 549 | 610 | 1.002-1.009 | 10 |
| 613 | p-cymene-d14 | 742 | 164 | 0.624-0.652 | 10 |
| 713 | p-cymene | 755 | 613 | 1.008-1.023 | 10 |
| 265 | phenol-d5 | 696 | 164 | 0.584-0.613 | 10 |
| 365 | phenol | 700 | 265 | 0.995-1.010 | 10 |
| 218 | bis(2-chloroethyl) ether-d8 | 696 | 164 | 0.584-0.607 | 10 |
| 318 | bis(2-chloroethyl) ether | 704 | 218 | 1.007-1.016 | 10 |
| 617 | n-decane-d22 | 698 | 164 | 0.585-0.615 | 10 |
| 717 | n-decane | 720 | 617 | 1.022-1.038 | 10 |
| 226 | 1,3-dichlorobenzene-d4 | 722 | 164 | 0.605-0.636 | 10 |
| 326 | 1,3-dichlorobenzene | 724 | 226 | 0.998-1.008 | 10 |
| 227 | 1,4-dichlorobenzene-d4 | 737 | 164 | 0.601-0.666 | 10 |
| 327 | 1,4-dichlorobenzene | 740 | 227 | 0.997-1.009 | 10 |
| 225 | 1,2-dichlorobenzene-d4 | 758 | 164 | 0.632-0.667 | 10 |
| 325 | 1,2-dichlorobenzene | 760 | 225 | 0.995-1.008 | 10 |
| 242 | bis(2-chloroisopropyl) ether-d12 | 788 | 164 | 0.664-0.691 | 10 |
| 342 | bis(2-chloroisopropyl) ether | 799 | 242 | 1.010-1.016 | 10 |
| 212 | hexachloroethane-13C | 819 | 164 | 0.690-0.717 | 10 |
| 312 | hexachloroethane | 823 | 212 | 0.999-1.001 | 10 |
| 063 | N-nitrosodi-n-propylamine | 830 | 164 | ns | 20 |
| 256 | nitrobenzene-d5 | 845 | 164 | 0.706-0.727 | 10 |
| 356 | nitrobenzene | 849 | 256 | 1.002-1.007 | 10 |
| 254 | isophorone-d8 | 881 | 164 | 0.747-0.767 | 10 |
| 354 | isophorone | 889 | 254 | 0.999-1.017 | 10 |
| 234 | 2,4-dimethyl phenol-d3 | 921 | 164 | 0.781-0.803 | 10 |
| 334 | 2,4-dimethylphenol | 924 | 234 | 0.999-1.003 | 10 |
| 043 | bis(2-chloroethoxy) methane | 939 | 164 | ns | 10 |
| 208 | 1,2,4-trichlorobenzene-d3 | 955 | 164 | 0.813-0.830 | 10 |
| 308 | 1,2,4-trichlorobenzene | 958 | 208 | 1.000-1.005 | 10 |
| 255 | naphthalene-d8 | 963 | 164 | 0.819-0.836 | 10 |
| 355 | naphthalene | 967 | 255 | 1.001-1.006 | 10 |
| 609 | alpha-terpineol-d3 | 973 | 164 | 0.829-0.844 | 10 |

TABLE 3—GAS CHROMATOGRAPHY OF BASE/NEUTRAL EXTRACTABLE COMPOUNDS—Continued

| EGD No. ¹ | Compound | Retention time | | | Detection limit ² (µg/L) |
|----------------------|--------------------------------------|----------------|---------|-------------|-------------------------------------|
| | | Mean (sec) | EGD Ref | Relative | |
| 709 | alpha-terpineol | 975 | 609 | 0.998-1.008 | 10 |
| 606 | n-dodecane-d26 | 953 | 164 | 0.730-0.908 | 10 |
| 706 | n-dodecane | 981 | 606 | 0.986-1.051 | 10 |
| 529 | 1,2,3-trichlorobenzene | 1003 | 164 | ns | 10 |
| 252 | hexachlorobutadiene-13C4 | 1005 | 164 | 0.856-0.871 | 10 |
| 352 | hexachlorobutadiene | 1006 | 252 | 0.999-1.002 | 10 |
| 253 | hexachlorocyclopentadiene-13C4 | 1147 | 164 | 0.976-0.986 | 10 |
| 353 | hexachlorocyclopentadiene | 1142 | 253 | 0.999-1.001 | 10 |
| 220 | 2-chloronaphthalene-d7 | 1185 | 164 | 1.014-1.024 | 10 |
| 320 | 2-chloronaphthalene | 1200 | 220 | 0.997-1.007 | 10 |
| 518 | n-tetradecane | 1203 | 164 | ns | 10 |
| 612 | Biphenyl-d10 | 1205 | 164 | 1.016-1.027 | 10 |
| 712 | Biphenyl | 1195 | 612 | 1.001-1.006 | 10 |
| 608 | Diphenyl ether-d10 | 1211 | 164 | 1.036-1.047 | 10 |
| 708 | Diphenyl ether | 1216 | 608 | 0.997-1.009 | 10 |
| 277 | Acenaphthylene-d8 | 1265 | 164 | 1.080-1.095 | 10 |
| 377 | Acenaphthylene | 1247 | 277 | 1.000-1.004 | 10 |
| 271 | Dimethyl phthalate-d4 | 1269 | 164 | 1.083-1.102 | 10 |
| 371 | Dimethyl phthalate | 1273 | 271 | 0.998-1.005 | 10 |
| 236 | 2,6-dinitrotoluene-d3 | 1283 | 164 | 1.090-1.112 | 10 |
| 336 | 2,6-dinitrotoluene | 1300 | 236 | 1.001-1.005 | 10 |
| 201 | Acenaphthene-d10 | 1298 | 164 | 1.107-1.125 | 10 |
| 301 | Acenaphthene | 1304 | 201 | 0.999-1.009 | 10 |
| 605 | Dibenzofuran-d8 | 1331 | 164 | 1.134-1.155 | 10 |
| 705 | Dibenzofuran | 1335 | 605 | 0.998-1.007 | 10 |
| 602 | Beta-naphthylamine-d7 | 1368 | 164 | 1.163-1.189 | 50 |
| 702 | Beta-naphthylamine | 1371 | 602 | 0.996-1.007 | 50 |
| 280 | Fluorene-d10 | 1395 | 164 | 1.185-1.214 | 10 |
| 380 | Fluorene | 1401 | 280 | 0.999-1.008 | 10 |
| 240 | 4-chlorophenyl phenyl ether-d5 | 1406 | 164 | 1.194-1.223 | 10 |
| 340 | 4-chlorophenyl phenyl ether | 1409 | 240 | 0.990-1.015 | 10 |
| 270 | Diethyl phthalate-d4 | 1409 | 164 | 1.197-1.229 | 10 |
| 370 | Diethyl phthalate | 1414 | 270 | 0.996-1.006 | 10 |
| 619 | n-hexadecane-d34 | 1447 | 164 | 1.010-1.478 | 10 |
| 719 | n-hexadecane | 1469 | 619 | 1.013-1.020 | 10 |
| 235 | 2,4-dinitrotoluene-d3 | 1359 | 164 | 1.152-1.181 | 10 |
| 335 | 2,4-dinitrotoluene | 1344 | 235 | 1.000-1.002 | 10 |
| 237 | 1,2-diphenylhydrazine-d8 | 1433 | 164 | 1.216-1.248 | 20 |
| 337 | 1,2-diphenylhydrazine (°) | 1439 | 237 | 0.999-1.009 | 20 |
| 607 | Diphenylamine-d10 | 1437 | 164 | 1.213-1.249 | 20 |
| 707 | Diphenylamine | 1439 | 607 | 1.000-1.007 | 20 |
| 262 | N-nitrosodiphenylamine-d6 | 1447 | 164 | 1.225-1.252 | 20 |
| 362 | N-nitrosodiphenylamine (°) | 1464 | 262 | 1.000-1.002 | 20 |
| 041 | 4-bromophenyl phenyl ether | 1498 | 164 | 1.271-1.307 | 10 |
| 209 | Hexachlorobenzene-13C6 | 1521 | 164 | 1.288-1.327 | 10 |
| 309 | Hexachlorobenzene | 1522 | 209 | 0.999-1.001 | 10 |
| 281 | Phenanthrene-d10 | 1578 | 164 | 1.334-1.380 | 10 |
| 520 | n-octadecane | 1580 | 164 | ns | 10 |
| 381 | Phenanthrene | 1583 | 281 | 1.000-1.005 | 10 |
| 278 | Anthracene-d10 | 1588 | 164 | 1.342-1.388 | 10 |
| 378 | Anthracene | 1592 | 278 | 0.998-1.006 | 10 |
| 604 | Dibenzothiophene-d8 | 1559 | 164 | 1.314-1.361 | 10 |
| 704 | Dibenzothiophene | 1564 | 604 | 1.000-1.006 | 10 |
| 528 | Carbazole | 1650 | 164 | ns | 20 |
| 621 | n-eicosane-d42 | 1655 | 164 | 1.184-1.662 | 10 |
| 721 | n-eicosane | 1677 | 621 | 1.010-1.021 | 10 |
| 268 | Di-n-butyl phthalate-d4 | 1719 | 164 | 1.446-1.510 | 10 |
| 368 | Di-n-butyl phthalate | 1723 | 268 | 1.000-1.003 | 10 |
| 239 | Fluoranthene-d10 | 1813 | 164 | 1.522-1.596 | 10 |
| 339 | Fluoranthene | 1817 | 239 | 1.000-1.004 | 10 |
| 284 | Pyrene-d10 | 1844 | 164 | 1.523-1.644 | 10 |
| 384 | Pyrene | 1852 | 284 | 1.001-1.003 | 10 |
| 205 | Benzidine-d8 | 1854 | 164 | 1.549-1.632 | 50 |
| 305 | Benzidine | 1853 | 205 | 1.000-1.002 | 50 |
| 522 | n-docosane | 1889 | 164 | ns | 10 |
| 623 | n-tetracosane-d50 | 1997 | 164 | 1.671-1.764 | 10 |
| 723 | n-tetracosane | 2025 | 612 | 1.012-1.015 | 10 |
| 067 | Butylbenzyl phthalate | 2060 | 164 | ns | 10 |
| 276 | Chrysene-d12 | 2081 | 164 | 1.743-1.837 | 10 |
| 376 | Chrysene | 2083 | 276 | 1.000-1.004 | 10 |

TABLE 3—GAS CHROMATOGRAPHY OF BASE/NEUTRAL EXTRACTABLE COMPOUNDS—Continued

| EGD No. ¹ | Compound | Retention time | | | Detection limit ² (µg/L) |
|----------------------|--------------------------------------|----------------|---------|-------------|-------------------------------------|
| | | Mean (sec) | EGD Ref | Relative | |
| 272 | Benzo(a)anthracene-d12 | 2082 | 164 | 1.735–1.846 | 10 |
| 372 | Benzo(a)anthracene | 2090 | 272 | 0.999–1.007 | 10 |
| 228 | 3,3'-dichlorobenzidine-d6 | 2088 | 164 | 1.744–1.848 | 50 |
| 328 | 3,3'-dichlorobenzidine | 2086 | 228 | 1.000–1.001 | 50 |
| 266 | Bis(2-ethylhexyl) phthalate-d4 | 2123 | 164 | 1.771–1.880 | 10 |
| 366 | Bis(2-ethylhexyl) phthalate | 2124 | 266 | 1.000–1.002 | 10 |
| 524 | n-hexacosane | 2147 | 164 | ns | 10 |
| 269 | di-n-octyl phthalate-d4 | 2239 | 164 | 1.867–1.982 | 10 |
| 369 | di-n-octyl phthalate | 2240 | 269 | 1.000–1.002 | 10 |
| 525 | n-octacosane | 2272 | 164 | ns | 10 |
| 274 | Benzo(b)fluoranthene-d12 | 2281 | 164 | 1.902–2.025 | 10 |
| 354 | Benzo(b)fluoranthene | 2293 | 274 | 1.000–1.005 | 10 |
| 275 | Benzo(k)fluoranthene-d12 | 2287 | 164 | 1.906–2.033 | 10 |
| 375 | Benzo(k)fluoranthene | 2293 | 275 | 1.000–1.005 | 10 |
| 273 | Benzo(a)pyrene-d12 | 2351 | 164 | 1.954–2.088 | 10 |
| 373 | Benzo(a)pyrene | 2350 | 273 | 1.000–1.004 | 10 |
| 626 | N-triacontane-d62 | 2384 | 164 | 1.972–2.127 | 10 |
| 726 | N-triacontane | 2429 | 626 | 1.011–1.028 | 10 |
| 083 | Indeno(1,2,3-cd)pyrene | 2650 | 164 | ns | 20 |
| 082 | Dibenzo(a,h)anthracene | 2660 | 164 | ns | 20 |
| 279 | Benzo(ghi)perylene-d12 | 2741 | 164 | 2.187–2.524 | 20 |
| 379 | Benzo(ghi)perylene | 2750 | 279 | 1.001–1.006 | 20 |

¹ Reference numbers beginning with 0, 1 or 5 indicate a pollutant quantified by the internal standard method; reference numbers beginning with 2 or 6 indicate a labeled compound quantified by the internal standard method; reference numbers beginning with 3 or 7 indicate a pollutant quantified by isotope dilution.

² This is a minimum level at which the entire GC/MS system must give recognizable mass spectra (background corrected) and acceptable calibration points.

³ Detected as azobenzene.

⁴ Detected as diphenylamine.

ns = specification not available at time of release of method.

Column: 30 ± 2 m × 0.25 ± 0.02 mm i.d. 94% methyl, 4% phenyl, 1% vinyl bonded phase fused silica capillary.

Temperature program: 5 min at 30 °C; 30 – 280 °C at 8 °C per min; isothermal at 280 °C until benzo(ghi)perylene elutes.

Gas velocity: 30 ± 5 cm/sec.

TABLE 4—GAS CHROMATOGRAPHY OF ACID EXTRACTABLE COMPOUNDS

| EGD No. ¹ | Compound | Retention time | | | Detection limit ² (µg/L) |
|----------------------|---------------------------------------|----------------|---------|-------------|-------------------------------------|
| | | Mean (sec) | EGD Ref | Relative | |
| 164 | 2,2'-difluorobiphenyl (int std) | 1163 | 164 | 1.000–1.000 | 10 |
| 224 | 2-chlorophenol-d4 | 701 | 164 | 0.587–0.618 | 10 |
| 324 | 2-chlorophenol | 705 | 224 | 0.997–1.010 | 10 |
| 257 | 2-nitrophenol-d4 | 898 | 164 | 0.761–0.783 | 20 |
| 357 | 2-nitrophenol | 900 | 257 | 0.994–1.009 | 20 |
| 231 | 2,4-dichlorophenol-d3 | 944 | 164 | 0.802–0.822 | 10 |
| 331 | 2,4-dichlorophenol | 947 | 231 | 0.997–1.006 | 10 |
| 222 | 4-chloro-3-methylphenol-d2 | 1086 | 164 | 0.930–0.943 | 10 |
| 322 | 4-chloro-3-methylphenol | 1091 | 222 | 0.998–1.003 | 10 |
| 221 | 2,4,6-trichlorophenol-d2 | 1162 | 164 | 0.994–1.005 | 10 |
| 321 | 2,4,6-trichlorophenol | 1165 | 221 | 0.998–1.004 | 10 |
| 531 | 2,4,5-trichlorophenol | 1170 | 164 | ns | 10 |
| 530 | 2,3,6-trichlorophenol | 1195 | 164 | ns | 10 |
| 259 | 2,4-dinitrophenol-d3 | 1323 | 164 | 1.127–1.149 | 50 |
| 359 | 2,4-dinitrophenol | 1325 | 259 | 1.000–1.005 | 50 |
| 258 | 4-nitrophenol-d4 | 1349 | 164 | 1.147–1.175 | 50 |
| 358 | 4-nitrophenol | 1354 | 258 | 0.997–1.006 | 50 |
| 260 | 2-methyl-4,6-dinitrophenol-d2 | 1433 | 164 | 1.216–1.249 | 20 |
| 360 | 2-methyl-4,6-dinitrophenol | 1435 | 260 | 1.000–1.002 | 20 |
| 264 | Pentachlorophenol-13C6 | 1559 | 164 | 1.320–1.363 | 50 |
| 364 | Pentachlorophenol | 1561 | 264 | 0.998–1.002 | 50 |

¹ Reference numbers beginning with 0, 1 or 5 indicate a pollutant quantified by the internal standard method; reference numbers beginning with 2 or 6 indicate a labeled compound quantified by the internal standard method; reference numbers beginning with 3 or 7 indicate a pollutant quantified by isotope dilution.

² This is a minimum level at which the entire GC/MS system must give recognizable mass spectra (background corrected) and acceptable calibration points.

ns=specification not available at time of release of method.

Column: 30 ± 2m×0.25 ± 0.02mm i.d. 94% methyl, 4% phenyl, 1% vinyl bonded phase fused silica capillary.

Temperature program: 5 min at 30 °C; 8 °C/min. to 250°C or until pentachlorophenol elutes.

Gas velocity: 30 ± 5 cm/sec.

TABLE 5—DFTPP MASS INTENSITY SPECIFICATIONS

| Mass | Intensity required |
|------|------------------------------------|
| 51 | 30–60 percent of mass 198. |
| 68 | Less than 2 percent of mass 69. |
| 70 | Less than 2 percent of mass 69. |
| 127 | 40–60 percent of mass 198. |
| 197 | Less than 1 percent of mass 198. |
| 199 | 5–9 percent of mass 198. |
| 275 | 10–30 percent of mass 198. |
| 365 | greater than 1 percent of mass 198 |
| 441 | present and less than mass 443 |
| 442 | 40–100 percent of mass 198. |
| 443 | 17–23 percent of mass 442. |

TABLE 6—BASE/NEUTRAL EXTRACTABLE COMPOUND CHARACTERISTIC MASSES

| Compound | Labeled analog | Primary m/z |
|------------------------------|----------------|-------------|
| Acenaphthene | d10 | 154/164 |
| Acenaphthylene | d8 | 152/160 |
| Anthracene | d10 | 178/188 |
| Benzidine | d8 | 184/192 |
| Benzo(a)anthracene | d12 | 228/240 |
| Benzo(b)fluoranthene | d12 | 252/264 |
| Benzo(k)fluoranthene | d12 | 252/264 |
| Benzo(a)pyrene | d12 | 252/264 |
| Benzo(ghi)perylene | d12 | 276/288 |
| Biphenyl | d10 | 154/164 |
| Bis(2-chloroethyl) ether | d8 | 93/101 |
| Bis(2-chloroethoxy)methane | | 93 |
| Bis(2-chloroisopropyl) ether | d12 | 121/131 |
| Bis(2-ethylhexyl) phthalate | d4 | 149/153 |
| 4-bromophenyl phenyl ether | | 248 |
| Butyl benzyl phthalate | | 149 |
| n-C10 | d22 | 55/66 |
| n-C12 | d26 | 55/66 |
| n-C14 | | 55 |
| n-C16 | d34 | 55/66 |
| n-C18 | | 55 |
| n-C20 | d42 | 55/66 |
| n-C22 | | 55 |
| n-C24 | d50 | 55/66 |
| n-C26 | | 55 |
| n-C28 | | 55 |
| n-C30 | d62 | 55/66 |
| Carbazole | d8 | 167/175 |
| 2-chloronaphthalene | d7 | 162/169 |
| 4-chlorophenyl phenyl ether | d5 | 204/209 |
| Chrysene | d12 | 228/240 |
| p-cymene | d14 | 114/130 |
| Dibenzo(a,h)anthracene | | 278 |
| Dibenzofuran | d8 | 168/176 |
| Dibenzothiophene | d8 | 184/192 |
| Di-n-butyl phthalate | d4 | 149/153 |
| 1,2-dichlorobenzene | d4 | 146/152 |
| 1,3-dichlorobenzene | d4 | 146/152 |

TABLE 6—BASE/NEUTRAL EXTRACTABLE COMPOUND CHARACTERISTIC MASSES—Continued

| Compound | Labeled analog | Primary m/z |
|-------------------------------------|----------------|-------------|
| 1,4-dichlorobenzene | d4 | 146/152 |
| 3,3'-dichlorobenzidine | d6 | 252/258 |
| Diethyl phthalate | d4 | 149/153 |
| 2,4-dimethylphenol | d3 | 122/125 |
| Dimethyl phthalate | d4 | 163/167 |
| 2,4-dinitrotoluene | d3 | 164/168 |
| 2,6-dinitrotoluene | d3 | 165/167 |
| Di-n-octyl phthalate | d4 | 149/153 |
| Diphenylamine | d10 | 169/179 |
| Diphenyl ether | d10 | 170/180 |
| 1,2-diphenylhydrazine ¹ | d10 | 77/82 |
| Fluoranthene | d10 | 202/212 |
| Fluorene | d10 | 166/176 |
| Hexachlorobenzene | 13C6 | 284/292 |
| Hexachlorobutadiene | 13C4 | 225/231 |
| Hexachloroethane | 13C | 201/204 |
| Hexachlorocyclopentadiene | 13C4 | 237/241 |
| Ideno(1,2,3-cd)pyrene | | 276 |
| Isophorone | d8 | 82/88 |
| Naphthalene | d8 | 128/136 |
| B-naphthylamine | d7 | 143/150 |
| Nitrobenzene | d5 | 123/128 |
| N-nitrosodimethylamine | | 74 |
| N-nitrosodi-n-propylamine | | 70 |
| N-nitrosodiphenylamine ² | d6 | 169/175 |
| Phenanthrene | d10 | 178/188 |
| Phenol | d5 | 94/71 |
| a-picoline | d7 | 93/100 |
| Pyrene | d10 | 202/212 |
| Styrene | d5 | 104/109 |
| a-terpineol | d3 | 59/62 |
| 1,2,3-trichlorobenzene | d3 | 180/183 |
| 1,2,4-trichlorobenzene | d3 | 180/183 |

¹ Detected as azobenzene.
² Detected as diphenylamine.

TABLE 7—ACID EXTRACTABLE COMPOUND CHARACTERISTIC MASSES

| Compound | Labeled analog | Primary m/z |
|----------------------------|----------------|-------------|
| 4-chloro-3-methylphenol | d2 | 107/109 |
| 2-chlorophenol | d4 | 128/132 |
| 2,4-dichlorophenol | d3 | 162/167 |
| 2,4-dinitrophenol | d3 | 184/187 |
| 2-methyl-4,6-dinitrophenol | d2 | 198/200 |
| 2-nitrophenol | d4 | 139/143 |
| 4-nitrophenol | d4 | 139/143 |
| Pentachlorophenol | 13C6 | 266/272 |
| 2,3,6-trichlorophenol | d2 | 196/200 |
| 2,4,5-trichlorophenol | d2 | 196/200 |
| 2,4,6-trichlorophenol | d2 | 196/200 |

TABLE 8—ACCEPTANCE CRITERIA FOR PERFORMANCE TESTS

| EGD No. ¹ | Compound | Acceptance criteria | | | | |
|----------------------|-------------------|---|--------|---|--|--------------------------------------|
| | | Initial precision and accuracy section 8.2.3 (µg/L) | | Labeled compound recovery sec. 8.3 and 14.2 P (percent) | Calibration verification sec. 12.5 (µg/mL) | On-going accuracy sec. 11.6 R (µg/L) |
| | | s | X | | | |
| 301 | Acenaphthene | 21 | 79–134 | | 80–125 | 72–144 |
| 201 | Acenaphthene-d10 | 38 | 38–147 | 20–270 | 71–141 | 30–180 |
| 377 | Acenaphthylene | 38 | 69–186 | | 60–166 | 61–207 |
| 277 | Acenaphthylene-d8 | 31 | 38–146 | 23–239 | 66–152 | 33–168 |

TABLE 8—ACCEPTANCE CRITERIA FOR PERFORMANCE TESTS—Continued

| EGD No. ¹ | Compound | Acceptance criteria | | | | |
|----------------------|--|---|--------|---|--|--------------------------------------|
| | | Initial precision and accuracy section 8.2.3 (µg/L) | | Labeled compound recovery sec. 8.3 and 14.2 P (percent) | Calibration verification sec. 12.5 (µg/mL) | On-going accuracy sec. 11.6 R (µg/L) |
| | | s | X | | | |
| 378 | Anthracene | 41 | 58–174 | | 60–168 | 50–199 |
| 278 | Anthracene-d10 | 49 | 31–194 | 14–419 | 58–171 | 23–242 |
| 305 | Benzidine | 119 | 16–518 | | 34–296 | 11–672 |
| 205 | Benzidine-d8 | 269 | ns-ns | ns-ns | ns-ns | ns-ns |
| 372 | Benzo(a)anthracene | 20 | 65–168 | | 70–142 | 62–176 |
| 272 | Benzo(a)anthracene-d12 | 41 | 25–298 | 12–605 | 28–357 | 22–329 |
| 374 | Benzo(b)fluoranthene | 183 | 32–545 | | 61–164 | 20–ns |
| 274 | Benzo(b)fluoranthene-d12 | 168 | 11–577 | ns-ns | 14–ns | ns-ns |
| 375 | Benzo(k)fluoranthene | 26 | 59–143 | | 13–ns | 53–155 |
| 275 | Benzo(k)fluoranthene-d12 | 114 | 15–514 | ns-ns | 13–ns | ns–685 |
| 373 | Benzo(a)pyrene | 26 | 62–195 | | 78–129 | 59–206 |
| 273 | Benzo(a)pyrene-d12 | 24 | 35–181 | 21–290 | 12–ns | 32–194 |
| 379 | Benzo(ghi)perylene | 21 | 72–160 | | 69–145 | 58–168 |
| 279 | Benzo(ghi)perylene-d12 | 45 | 29–268 | 14–529 | 13–ns | 25–303 |
| 712 | Biphenyl (Appendix C) | 41 | 75–148 | | 58–171 | 62–176 |
| 612 | Biphenyl-d12 | 43 | 28–165 | ns-ns | 52–192 | 17–267 |
| 318 | Bis(2-chloroethyl) ether | 34 | 55–196 | | 61–164 | 50–213 |
| 218 | Bis(2-chloroethyl) ether-d8 | 33 | 29–196 | 15–372 | 52–194 | 25–222 |
| 043 | Bis(2-chloroethoxy)methane* | 27 | 43–153 | | 44–228 | 39–166 |
| 342 | Bis(2-chloroisopropyl) ether | 17 | 81–138 | | 67–148 | 77–145 |
| 242 | Bis(2-chloroisopropyl) ether-d12 | 27 | 35–149 | 20–260 | 44–229 | 30–169 |
| 366 | Bis(2-ethylhexyl) phthalate | 31 | 69–220 | | 76–131 | 64–232 |
| 266 | Bis(2-ethylhexyl) phthalate-d4 | 29 | 32–205 | 18–364 | 43–232 | 28–224 |
| 041 | 4-bromophenyl phenyl ether* | 44 | 44–140 | | 52–193 | 35–172 |
| 067 | Butyl benzyl phthalate* | 31 | 19–233 | | 22–450 | 35–170 |
| 717 | n-C10 (Appendix C) | 51 | 24–195 | | 42–235 | 19–237 |
| 617 | n-C10-d22 | 70 | ns–298 | ns-ns | 44–227 | ns–504 |
| 706 | n-C12 (Appendix C) | 74 | 35–369 | | 60–166 | 29–424 |
| 606 | n-C12-d26 | 53 | ns–331 | ns-ns | 41–242 | ns–408 |
| 518 | n-C14 (Appendix C)* | 109 | ns–985 | | 37–268 | ns-ns |
| 719 | n-C16 (Appendix C) | 33 | 80–162 | | 72–138 | 71–181 |
| 619 | n-C16-d34 | 46 | 37–162 | 18–308 | 54–186 | 28–202 |
| 520 | n-C18 (Appendix C)* | 39 | 42–131 | | 40–249 | 35–167 |
| 721 | n-C20 (Appendix C) | 59 | 53–263 | | 54–184 | 46–301 |
| 621 | n-C20-d42 | 34 | 34–172 | 19–306 | 62–162 | 29–198 |
| 522 | n-C22 (Appendix C)* | 31 | 45–152 | | 40–249 | 39–195 |
| 723 | n-C24 (Appendix C) | 11 | 80–139 | | 65–154 | 78–142 |
| 623 | n-C24-d50 | 28 | 27–211 | 15–376 | 50–199 | 25–229 |
| 524 | n-C26 (Appendix C)* | 35 | 35–193 | | 26–392 | 31–212 |
| 525 | n-C28 (Appendix C)* | 35 | 35–193 | | 26–392 | 31–212 |
| 726 | n-C30 (Appendix C) | 32 | 61–200 | | 66–152 | 56–215 |
| 626 | n-C30-d62 | 41 | 27–242 | 13–479 | 24–423 | 23–274 |
| 528 | Carbazole (4c)* | 38 | 36–165 | | 44–227 | 31–188 |
| 320 | 2-chloronaphthalene | 100 | 46–357 | | 58–171 | 35–442 |
| 220 | 2-chloronaphthalene-d7 | 41 | 30–168 | 15–324 | 72–139 | 24–204 |
| 322 | 4-chloro-3-methylphenol | 37 | 76–131 | | 85–115 | 62–159 |
| 222 | 4-chloro-3-methylphenol-d2 | 111 | 30–174 | ns–613 | 68–147 | 14–314 |
| 324 | 2-chlorophenol | 13 | 79–135 | | 78–129 | 76–138 |
| 224 | 2-chlorophenol-d4 | 24 | 36–162 | 23–255 | 55–180 | 33–176 |
| 340 | 4-chlorophenyl phenyl ether | 42 | 75–166 | | 71–142 | 63–194 |
| 240 | 4-chlorophenyl phenyl ether-d5 | 52 | 40–161 | 19–325 | 57–175 | 29–212 |
| 376 | Chrysene | 51 | 59–186 | | 70–142 | 48–221 |
| 276 | Chrysene-d12 | 69 | 33–219 | 13–512 | 24–411 | 23–290 |
| 713 | p-cymene (Appendix C) | 18 | 76–140 | | 79–127 | 72–147 |
| 613 | p-cymene-d14 | 67 | ns–359 | ns-ns | 66–152 | ns–468 |
| 082 | Dibenzo(a,h)anthracene* | 55 | 23–299 | | 13–761 | 19–340 |
| 705 | Dibenzofuran (Appendix C) | 20 | 85–136 | | 73–136 | 79–146 |
| 605 | Dibenzofuran-d8 | 31 | 47–136 | 28–220 | 66–150 | 39–160 |
| 704 | Dibenzothiophene (Synfuel) | 31 | 79–150 | | 72–140 | 70–168 |
| 604 | Dibenzothiophene-d8 | 31 | 48–130 | 29–215 | 69–145 | 40–156 |
| 368 | Di-n-butyl phthalate | 15 | 76–165 | | 71–142 | 74–169 |
| 268 | Di-n-butyl phthalate-d4 | 23 | 23–195 | 13–346 | 52–192 | 22–209 |
| 325 | 1,2-dichlorobenzene | 17 | 73–146 | | 74–135 | 70–152 |
| 225 | 1,2-dichlorobenzene-d4 | 35 | 14–212 | ns–494 | 61–164 | 11–247 |
| 326 | 1,3-dichlorobenzene | 43 | 63–201 | | 65–154 | 55–225 |
| 226 | 1,3-dichlorobenzene-d4 | 48 | 13–203 | ns–550 | 52–192 | ns–260 |
| 327 | 1,4-dichlorobenzene | 42 | 61–194 | | 62–161 | 53–219 |

TABLE 8—ACCEPTANCE CRITERIA FOR PERFORMANCE TESTS—Continued

| EGD No. ¹ | Compound | Acceptance criteria | | | | |
|----------------------|--------------------------------|---|--------|---|--|--------------------------------------|
| | | Initial precision and accuracy section 8.2.3 (µg/L) | | Labeled compound recovery sec. 8.3 and 14.2 P (percent) | Calibration verification sec. 12.5 (µg/mL) | On-going accuracy sec. 11.6 R (µg/L) |
| | | s | X | | | |
| 227 | 1,4-dichlorobenzene-d4 | 48 | 15–193 | ns–474 | 65–153 | 11–245 |
| 328 | 3,3'-dichlorobenzidine | 26 | 68–174 | | 77–130 | 64–185 |
| 228 | 3,3'-dichlorobenzidine-d6 | 80 | ns–562 | ns-ns | 18–558 | ns-ns |
| 331 | 2,4-dichlorophenol | 12 | 85–131 | | 67–149 | 83–135 |
| 231 | 2,4-dichlorophenol-d3 | 28 | 38–164 | 24–260 | 64–157 | 34–182 |
| 370 | Diethyl phthalate | 44 | 75–196 | | 74–135 | 65–222 |
| 270 | Diethyl phthalate-d4 | 78 | ns–260 | ns-ns | 47–211 | ns-ns |
| 334 | 2,4-dimethylphenol | 13 | 62–153 | | 67–150 | 60–156 |
| 234 | 2,4-dimethylphenol-d3 | 22 | 15–228 | ns–449 | 58–172 | 14–242 |
| 371 | Dimethyl phthalate | 36 | 74–188 | | 73–137 | 67–207 |
| 271 | Dimethyl phthalate-d4 | 108 | ns–640 | ns-ns | 50–201 | ns-ns |
| 359 | 2,4-dinitrophenol | 18 | 72–134 | | 75–133 | 68–141 |
| 259 | 2,4-dinitrophenol-d3 | 66 | 22–308 | ns-ns | 39–256 | 17–378 |
| 335 | 2,4-dinitrotoluene | 18 | 75–158 | | 79–127 | 72–164 |
| 235 | 2,4-dinitrotoluene-d3 | 37 | 22–245 | 10–514 | 53–187 | 19–275 |
| 336 | 2,6-dinitrotoluene | 30 | 80–141 | | 55–183 | 70–159 |
| 236 | 2,6-dinitrotoluene-d3 | 59 | 44–184 | 17–442 | 36–278 | 31–250 |
| 369 | Di-n-octyl phthalate | 16 | 77–161 | | 71–140 | 74–166 |
| 269 | Di-n-octyl phthalate-d4 | 46 | 12–383 | ns-ns | 21–467 | 10–433 |
| 707 | Diphenylamine (Appendix C) | 45 | 58–205 | | 57–176 | 51–231 |
| 607 | Diphenylamine-d10 | 42 | 27–206 | 11–488 | 59–169 | 21–249 |
| 708 | Diphenyl ether (Appendix C) | 19 | 82–136 | | 83–120 | 77–144 |
| 608 | Diphenyl ether-d10 | 37 | 36–155 | 19–281 | 77–129 | 29–186 |
| 337 | 1,2-diphenylhydrazine | 73 | 49–308 | | 75–134 | 40–360 |
| 237 | 1,2-diphenylhydrazine-d10 | 35 | 31–173 | 17–316 | 58–174 | 26–200 |
| 339 | Fluoranthene | 33 | 71–177 | | 67–149 | 64–194 |
| 239 | Fluoranthene-d10 | 35 | 36–161 | 20–278 | 47–215 | 30–187 |
| 380 | Fluorene | 29 | 81–132 | | 74–135 | 70–151 |
| 280 | Fluorene-d10 | 43 | 51–131 | 27–238 | 61–164 | 38–172 |
| 309 | Hexachlorobenzene | 16 | 90–124 | | 78–128 | 85–132 |
| 209 | Hexachlorobenzene-13C6 | 81 | 36–228 | 13–595 | 38–265 | 23–321 |
| 352 | hexachlorobutadiene | 56 | 51–251 | | 74–135 | 43–287 |
| 252 | hexachlorobutadiene-13C4 | 63 | ns–316 | ns-ns | 68–148 | ns–413 |
| 312 | hexachloroethane | 227 | 21–ns | | 71–141 | 13–ns |
| 212 | hexachloroethane-13C1 | 77 | ns–400 | ns-ns | 47–212 | ns–563 |
| 353 | hexachlorocyclopentadiene | 15 | 69–144 | | 77–129 | 67–148 |
| 253 | hexachlorocyclopentadiene-13C4 | 60 | ns-ns | ns-ns | 47–211 | ns-ns |
| 083 | ideno(1,2,3-cd)pyrene* | 55 | 23–299 | | 13–761 | 19–340 |
| 354 | isophorone | 25 | 76–156 | | 70–142 | 70–168 |
| 254 | isophorone-d8 | 23 | 49–133 | 33–193 | 52–194 | 44–147 |
| 360 | 2-methyl-4,6-dinitrophenol | 19 | 77–133 | | 69–145 | 72–142 |
| 260 | 2-methyl-4,6-dinitrophenol-d2 | 64 | 36–247 | 16–527 | 56–177 | 28–307 |
| 355 | naphthalene | 20 | 80–139 | | 73–137 | 75–149 |
| 255 | naphthalene-d8 | 39 | 28–157 | 14–305 | 71–141 | 22–192 |
| 702 | B-naphthylamine (Appendix C) | 49 | 10–ns | | 39–256 | ns-ns |
| 602 | B-naphthylamine-d7 | 33 | ns-ns | ns-ns | 44–230 | ns-ns |
| 356 | nitrobenzene | 25 | 69–161 | | 85–115 | 65–169 |
| 256 | nitrobenzene-d5 | 28 | 18–265 | ns-ns | 46–219 | 15–314 |
| 357 | 2-nitrophenol | 15 | 78–140 | | 77–129 | 75–145 |
| 257 | 2-nitrophenol-d4 | 23 | 41–145 | 27–217 | 61–163 | 37–158 |
| 358 | 4-nitrophenol | 42 | 62–146 | | 55–183 | 51–175 |
| 258 | 4-nitrophenol-d4 | 188 | 14–398 | ns-ns | 35–287 | ns-ns |
| 061 | N-nitrosodimethylamine* | 198 | 21–472 | | 40–249 | 12–807 |
| 063 | N-nitrosodi-n-propylamine* | 198 | 21–472 | | 40–249 | 12–807 |
| 362 | N-nitrosodiphenylamine | 45 | 65–142 | | 68–148 | 53–173 |
| 262 | N-nitrosodiphenylamine-d6 | 37 | 54–126 | 26–256 | 59–170 | 40–166 |
| 364 | pentachlorophenol | 21 | 76–140 | | 77–130 | 71–150 |
| 264 | pentachlorophenol-13C6 | 49 | 37–212 | 18–412 | 42–237 | 29–254 |
| 381 | phenanthrene | 13 | 93–119 | | 75–133 | 87–126 |
| 281 | phenanthrene-d10 | 40 | 45–130 | 24–241 | 67–149 | 34–168 |
| 365 | phenol | 36 | 77–127 | | 65–155 | 62–154 |
| 265 | phenol-d5 | 161 | 21–210 | ns-ns | 48–208 | ns-ns |
| 703 | a-picoline (Synfuel) | 38 | 59–149 | | 60–165 | 50–174 |
| 603 | a-picoline-d7 | 138 | 11–380 | ns-ns | 31–324 | ns–608 |
| 384 | pyrene | 19 | 76–152 | | 76–132 | 72–159 |
| 284 | pyrene-d10 | 29 | 32–176 | 18–303 | 48–210 | 28–196 |
| 710 | styrene (Appendix C) | 42 | 53–221 | | 65–153 | 48–244 |

TABLE 8—ACCEPTANCE CRITERIA FOR PERFORMANCE TESTS—Continued

| EGD No. ¹ | Compound | Acceptance criteria | | | | |
|----------------------|------------------------------------|---|--------|---|--|--------------------------------------|
| | | Initial precision and accuracy section 8.2.3 (µg/L) | | Labeled compound recovery sec. 8.3 and 14.2 P (percent) | Calibration verification sec. 12.5 (µg/mL) | On-going accuracy sec. 11.6 R (µg/L) |
| | | s | X | | | |
| 610 | styrene-d5 | 49 | ns-281 | ns-ns | 44-228 | ns-348 |
| 709 | a-terpineol (Appendix C) | 44 | 42-234 | | 54-186 | 38-258 |
| 609 | a-terpineol-d3 | 48 | 22-292 | ns-672 | 20-502 | 18-339 |
| 529 | 1,2,3-trichlorobenzene (4c)* | 69 | 15-229 | | 60-167 | 11-297 |
| 308 | 1,2,4-trichlorobenzene | 19 | 82-136 | | 78-128 | 77-144 |
| 208 | 1,2,4-trichlorobenzene-d3 | 57 | 15-212 | ns-592 | 61-163 | 10-282 |
| 530 | 2,3,6-trichlorophenol (4c)* | 30 | 58-137 | | 56-180 | 51-153 |
| 531 | 2,4,5-trichlorophenol (4c)* | 30 | 58-137 | | 56-180 | 51-153 |
| 321 | 2,4,6-trichlorophenol | 57 | 59-205 | | 81-123 | 48-244 |
| 221 | 2,4,6-trichlorophenol-d2 | 47 | 43-183 | 21-363 | 69-144 | 34-226 |

¹ Reference numbers beginning with 0, 1 or 5 indicate a pollutant quantified by the internal standard method; reference numbers beginning with 2 or 6 indicate a labeled compound quantified by the internal standard method; reference numbers beginning with 3 or 7 indicate a pollutant quantified by isotope dilution.

* Measured by internal standard; specification derived from related compound.

ns=no specification; limit is outside the range that can be measured reliably.

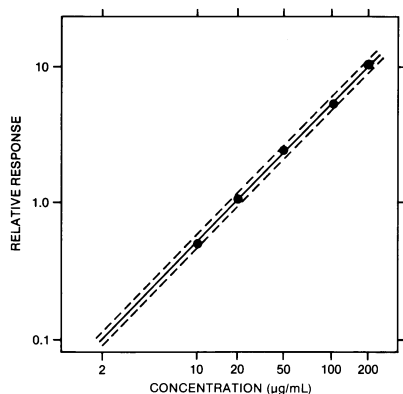

FIGURE 1 Relative Response Calibration Curve for Phenol. The Dotted Lines Enclose a ± 10 Percent Error Window.

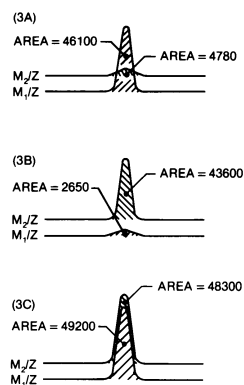

FIGURE 3 Extracted Ion Current Profiles for (3A) Unlabeled Compound, (3B) Labeled Compound, and (3C) Equal Mixture of Unlabeled and Labeled Compounds.

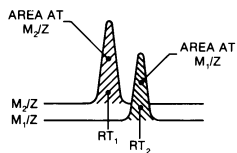

FIGURE 2 Extracted Ion Current Profiles for Chromatographically Resolved Labeled (m/z) and Unlabeled (m/z) Pairs.

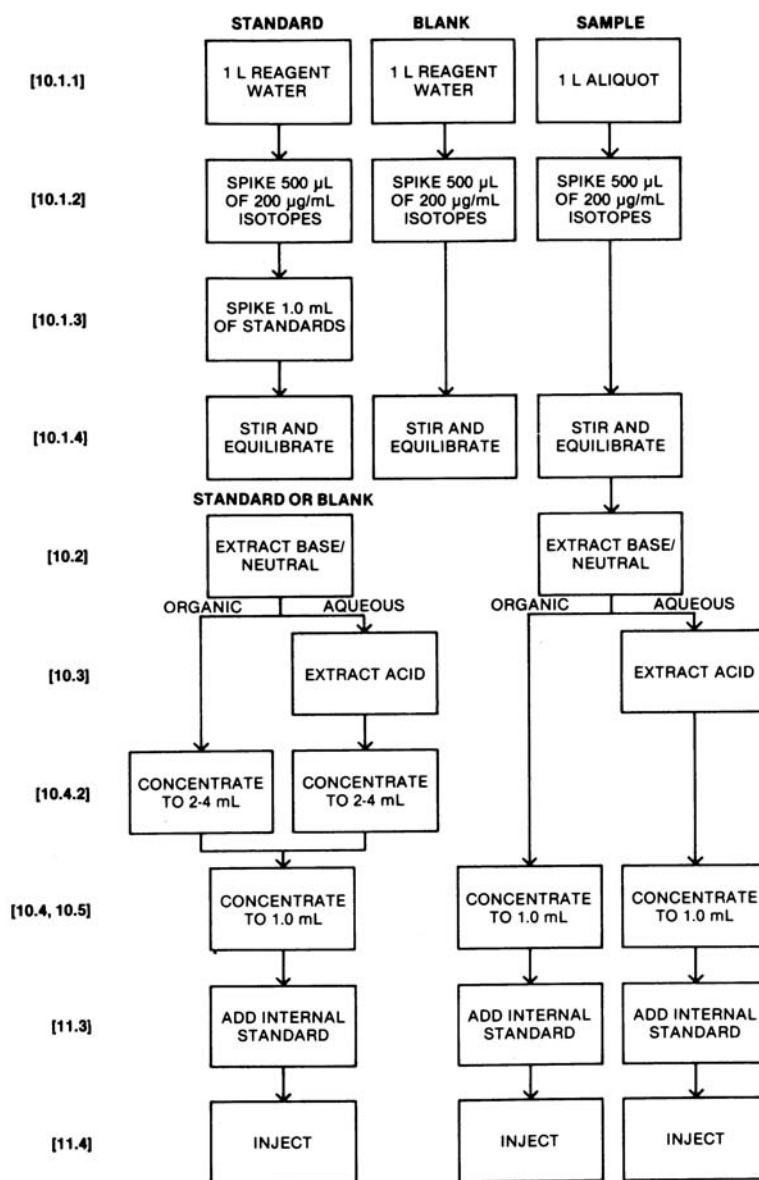

FIGURE 4 Flow Chart for Extraction/Concentration of Precision and Recovery Standard, Blank, and Sample by Method 1625. Numbers in Brackets [] Refer to Section Numbers in the Method.

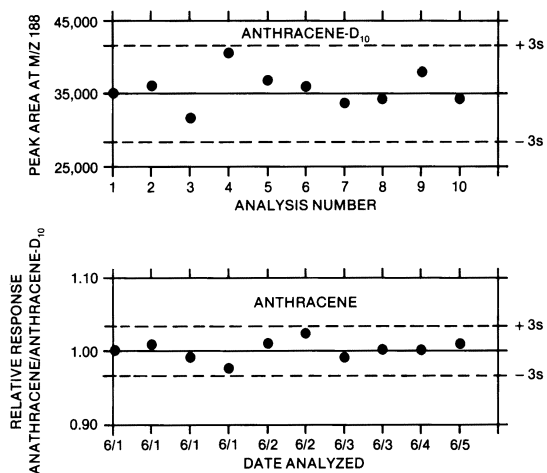

FIGURE 5 Quality Control Charts Showing Area (top graph) and Relative Response of Anthracene to Anthracene-d₁₀ (lower graph) Plotted as a Function of Time or Analysis Number.

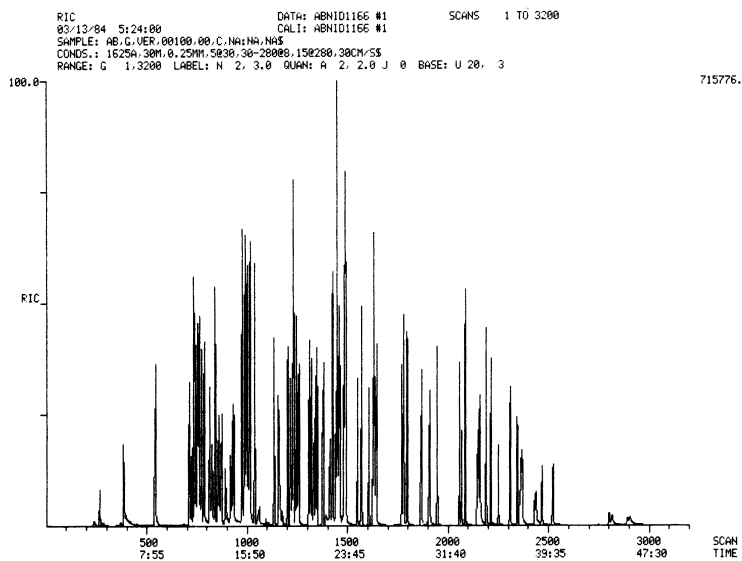

FIGURE 6 Chromatogram of Combined Acid/base/neutral Standard.

ATTACHMENT 1 TO METHOD 1625

INTRODUCTION

To support measurement of several semivolatile pollutants, EPA has developed this attachment to EPA Method 1625B.¹ The modifications listed in this attachment are approved only for monitoring wastestreams from the Centralized Waste Treatment Point Source Category (40 CFR Part 437) and the Landfills Point Source Category (40 CFR Part 445). EPA Method 1625B (the Method) employs sample extraction with methylene chloride followed by analysis of the extract using capillary column gas chromatography-mass spectrometry (GC/MS). This attachment addresses the addition of the semivolatile pollutants listed in Tables 1 and 2 to all applicable standard, stock, and spiking solutions utilized for the determination of semivolatile organic compounds by EPA Method 1625B.

1.0 EPA METHOD 1625 REVISION B
MODIFICATION SUMMARY

The additional semivolatile organic compounds listed in Tables 1 and 2 are added to all applicable calibration, spiking, and other solutions utilized in the determination of semivolatile compounds by EPA Method 1625. The instrument is to be calibrated with these compounds, and all procedures and quality control tests described in the Method must be performed.

2.0 SECTION MODIFICATIONS

NOTE: All section and figure numbers in this Attachment reference section and figure numbers in EPA Method 1625 Revision B unless noted otherwise. Sections not listed here remain unchanged.

Section 6.7 The stock standard solutions described in this section are modified such that the analytes in Tables 1 and 2 of this attachment are required in addition to those specified in the Method.

Section 6.8 The labeled compound spiking solution in this section is modified to include the labeled compounds listed in Tables 5 and 6 of this attachment.

Section 6.9 The secondary standard is modified to include the additional analytes

listed in Tables 1 and 2 of this attachment.

Section 6.12 The solutions for obtaining authentic mass spectra are to include all additional analytes listed in Tables 1 and 2 of this attachment.

Section 6.13 The calibration solutions are modified to include the analytes listed in Tables 1 and 2 and the labeled compounds listed in Tables 5 and 6 of this attachment.

Section 6.14 The precision and recovery standard is modified to include the analytes listed in Tables 1 and 2 and the labeled compounds listed in Tables 5 and 6 of this attachment.

Section 6.15 The solutions containing the additional analytes listed in Tables 1 and 2 of this attachment are to be analyzed for stability.

Section 7.2.1 This section is modified to include the analytes listed in Tables 1 and 2 and the labeled compounds listed in Tables 5 and 6 of this attachment.

Section 7.4.5 This section is modified to include the analytes listed in Tables 1 and 2 and the labeled compounds listed in Tables 5 and 6 in the calibration.

Section 8.2 The initial precision and recovery (IPR) requirements are modified to include the analytes listed in Tables 1 and 2 and the labeled compounds listed in Tables 5 and 6 of this attachment. Additional IPR performance criteria are supplied in Table 7 of this attachment.

Section 8.3 The labeled compounds listed in Tables 3 and 4 of this attachment are to be included in the method performance tests. Additional method performance criteria are supplied in Table 7 of this attachment.

Section 8.5.2 The acceptance criteria for blanks includes the analytes listed in Tables 1 and 2 of this attachment.

Section 10.1.2 The labeled compound solution must include the labeled compounds listed in Tables 5 and 6 of this attachment.

Section 10.1.3 The precision and recovery standard must include the analytes listed in Tables 1 and 2 and the labeled compounds listed in Tables 5 and 6 of this attachment.

Section 12.5 Additional QC requirements for calibration verification are supplied in Table 7 of this attachment.

Section 12.7 Additional QC requirements for ongoing precision and recovery are supplied in Table 7 of this attachment.

¹EPA Method 1625 Revision B, Semivolatile Organic Compounds by Isotope Dilution GC/MS, 40 CFR Part 136, Appendix A.

TABLE 1—BASE/NEUTRAL EXTRACTABLE COMPOUNDS

| Compound | Pollutant | |
|---|--------------|---------|
| | CAS Registry | EPA-EGD |
| acetophenone ¹ | 98-86-2 | 758 |
| aniline ² | 62-53-3 | 757 |
| -2,3-dichloroaniline ¹ | 608-27-5 | 578 |
| -o-cresol ¹ | 95-48-7 | 771 |
| pyridine ² | 110-86-1 | 1330 |

CAS = Chemical Abstracts Registry.

EGD = Effluent Guidelines Division.

¹ Analysis of this pollutant is approved only for the Centralized Waste Treatment industry.² Analysis of this pollutant is approved only for the Centralized Waste Treatment and Landfills industries.

TABLE 2—ACID EXTRACTABLE COMPOUNDS

| Compound | Pollutant | |
|-----------------------------|--------------|---------|
| | CAS Registry | EPA-EGD |
| p-cresol ¹ | 106-44-5 | 1744 |

CAS = Chemical Abstracts Registry.

EGD = Effluent Guidelines Division.

¹ Analysis of this pollutant is approved only for the Centralized Waste Treatment and Landfills industries.TABLE 3—GAS CHROMATOGRAPHY¹ OF BASE/NEUTRAL EXTRACTABLE COMPOUNDS

| EGD No. | Compound | Retention time ² | | | Minimum level ³ (µg/L) |
|------------|--|-----------------------------|---------|-------------|-----------------------------------|
| | | Mean (sec) | EGD Ref | Relative | |
| 758 | acetophenone ⁴ | 818 | 658 | 1.003-1.005 | 10 |
| 757 | aniline ⁵ | 694 | 657 | 0.994-1.023 | 10 |
| 578 | 2,3-dichloroaniline ⁴ | 1160 | 164 | 1.003-1.007 | 10 |
| 771 | o-cresol ⁴ | 814 | 671 | 1.005-1.009 | 10 |
| 1330 | pyridine ⁵ | 378 | 1230 | 1.005-1.011 | 10 |

EGD = Effluent Guidelines Division.

¹ The data presented in this table were obtained under the chromatographic conditions given in the footnote to Table 3 of EPA Method 1625B.² Retention times are approximate and are intended to be consistent with the retention times for the analytes in EPA Method 1625B.³ See the definition in footnote 2 to Table 3 of EPA Method 1625B.⁴ Analysis of this pollutant is approved only for the Centralized Waste Treatment industry.⁵ Analysis of this pollutant is approved only for the Centralized Waste Treatment and Landfills industries.TABLE 4—GAS CHROMATOGRAPHY¹ OF ACID EXTRACTABLE COMPOUNDS

| EGD No. | Compound | Retention time ² | | | Minimum level (µ/L) ³ |
|------------|-----------------------------|-----------------------------|---------|-------------|----------------------------------|
| | | Mean (sec) | EGD Ref | Relative | |
| 1744 | p-cresol ⁴ | 834 | 1644 | 1.004-1.008 | 20 |

EGD = Effluent Guidelines Division.

¹ The data presented in this table were obtained under the chromatographic conditions given in the footnote to Table 4 of EPA Method 1625B.² Retention times are approximate and are intended to be consistent with the retention times for the analytes in EPA Method 1625B.³ See the definition in footnote 2 to Table 4 of EPA Method 1625B.⁴ Analysis of this pollutant is approved only for the Centralized Waste Treatment and Landfills industries.

TABLE 5—BASE/NEUTRAL EXTRACTABLE COMPOUND CHARACTERISTIC M/Z'S

| Compound | Labeled Analog | Primary m/z ¹ |
|--|----------------|--------------------------|
| acetophenone ² | d ₅ | 105/110 |
| aniline ³ | d ₇ | 93/100 |
| o-cresol ² | d ₇ | 108/116 |
| 2,3-dichloroaniline ² | n/a | 161 |
| pyridine ³ | d ₅ | 79/84 |

m/z = mass to charge ratio.

¹ Native/labeled.
² Analysis of this pollutant is approved only for the Centralized Waste Treatment industry.
³ Analysis of this pollutant is approved only for the Centralized Waste Treatment and Landfills industries.

TABLE 6—ACID EXTRACTABLE COMPOUND CHARACTERISTIC M/Z'S

| Compound | Labeled Ana- log | Primary m/z ¹ |
|-----------------------|---------------------|-----------------------------|
| p-cresol ² | d ₇ | 108/116 |

m/z = mass to charge ratio.
¹ Native/labeled.
² Analysis of this pollutant is approved only for the Centralized Waste Treatment and Landfills industries.

TABLE 7—ACCEPTANCE CRITERIA FOR PERFORMANCE TESTS

| EGD No. | Compound | Acceptance criteria | | | Calibration verification sec. 12.5 µg/mL | On-going accuracy sec. 12.7 R (µg/L) |
|---------|--|---|--------|--|---|---|
| | | Initial precision and accu- racy section 8.2 (µg/L) | | Labeled compound recovery sec. 8.3 and 14.2 F (percent) | | |
| | | s (µg/L) | X | | | |
| 758 | acetophenone ¹ | 34 | 44-167 | | 85-115 | 45-162 |
| 658 | acetophenone-d ₅ ¹ | 51 | 23-254 | 45-162 | 85-115 | 22-264 |
| 757 | aniline ² | 32 | 30-171 | | 85-115 | 33-154 |
| 657 | aniline-d ₇ ² | 71 | 15-278 | 33-154 | 85-115 | 12-344 |
| 771 | o-cresol ¹ | 40 | 31-226 | | 85-115 | 35-196 |
| 671 | o-cresol-d ₇ ¹ | 23 | 30-146 | 35-196 | 85-115 | 31-142 |
| 1744 | p-cresol ² | 59 | 54-140 | | 85-115 | 37-203 |
| 1644 | p-cresol-d ₇ ² | 22 | 11-618 | 37-203 | 85-115 | 16-415 |
| 578 | 2,3-dichloroaniline ¹ | 13 | 40-160 | | 85-115 | 44-144 |
| 1330 | pyridine ² | 28 | 10-421 | | 83-117 | 18-238 |
| 1230 | pyridine-d ₅ ² | ns | 7-392 | 19-238 | 85-115 | 4-621 |

s = Standard deviation of four recovery measurements.
X = Average recovery for four recovery measurements.
EGD = Effluent Guidelines Division.
ns = no specification; limit is outside the range that can be measured reliably.
¹ Analysis of this pollutant is approved only for the Centralized Waste Treatment industry.
² Analysis of this pollutant is approved only for the Centralized Waste Treatment and Landfills industries.

[49 FR 43261, Oct. 26, 1984; 50 FR 692, 695, Jan. 4, 1985, as amended at 51 FR 23702, June 30, 1986; 62 FR 48405, Sept. 15, 1997; 65 FR 3044, Jan. 19, 2000; 65 FR 81295, 81298, Dec. 22, 2000]

APPENDIX B TO PART 136—DEFINITION AND PROCEDURE FOR THE DETERMINATION OF THE METHOD DETECTION LIMIT—REVISION 1.11

Definition

The method detection limit (MDL) is defined as the minimum concentration of a substance that can be measured and reported with 99% confidence that the analyte concentration is greater than zero and is determined from analysis of a sample in a given matrix containing the analyte.

Scope and Application

This procedure is designed for applicability to a wide variety of sample types ranging from reagent (blank) water containing analyte to wastewater containing analyte. The MDL for an analytical procedure may vary as a function of sample type. The procedure requires a complete, specific, and well defined analytical method. It is essential that all sample processing steps of the ana-

lytical method be included in the determination of the method detection limit.

The MDL obtained by this procedure is used to judge the significance of a single measurement of a future sample.

The MDL procedure was designed for applicability to a broad variety of physical and chemical methods. To accomplish this, the procedure was made device- or instrument-independent.

Procedure

1. Make an estimate of the detection limit using one of the following:

- (a) The concentration value that corresponds to an instrument signal/noise in the range of 2.5 to 5.
- (b) The concentration equivalent of three times the standard deviation of replicate instrumental measurements of the analyte in reagent water.
- (c) That region of the standard curve where there is a significant change in sensitivity, i.e., a break in the slope of the standard curve.

(d) Instrumental limitations.

It is recognized that the experience of the analyst is important to this process. However, the analyst must include the above considerations in the initial estimate of the detection limit.

2. Prepare reagent (blank) water that is as free of analyte as possible. Reagent or interference free water is defined as a water sample in which analyte and interferent concentrations are not detected at the method detection limit of each analyte of interest. Interferences are defined as systematic errors in the measured analytical signal of an established procedure caused by the presence of interfering species (interferent). The interferent concentration is presupposed to be normally distributed in representative samples of a given matrix.

3. (a) If the MDL is to be determined in reagent (blank) water, prepare a laboratory standard (analyte in reagent water) at a concentration which is at least equal to or in the same concentration range as the estimated method detection limit. (Recommend between 1 and 5 times the estimated method detection limit.) Proceed to Step 4.

(b) If the MDL is to be determined in another sample matrix, analyze the sample. If the measured level of the analyte is in the recommended range of one to five times the estimated detection limit, proceed to Step 4.

If the measured level of analyte is less than the estimated detection limit, add a known amount of analyte to bring the level of analyte between one and five times the estimated detection limit.

If the measured level of analyte is greater than five times the estimated detection limit, there are two options.

(1) Obtain another sample with a lower level of analyte in the same matrix if possible.

(2) The sample may be used as is for determining the method detection limit if the analyte level does not exceed 10 times the MDL of the analyte in reagent water. The variance of the analytical method changes as the analyte concentration increases from the MDL, hence the MDL determined under

these circumstances may not truly reflect method variance at lower analyte concentrations.

4. (a) Take a minimum of seven aliquots of the sample to be used to calculate the method detection limit and process each through the entire analytical method. Make all computations according to the defined method with final results in the method reporting units. If a blank measurement is required to calculate the measured level of analyte, obtain a separate blank measurement for each sample aliquot analyzed. The average blank measurement is subtracted from the respective sample measurements.

(b) It may be economically and technically desirable to evaluate the estimated method detection limit before proceeding with 4a. This will: (1) Prevent repeating this entire procedure when the costs of analyses are high and (2) insure that the procedure is being conducted at the correct concentration. It is quite possible that an inflated MDL will be calculated from data obtained at many times the real MDL even though the level of analyte is less than five times the calculated method detection limit. To insure that the estimate of the method detection limit is a good estimate, it is necessary to determine that a lower concentration of analyte will not result in a significantly lower method detection limit. Take two aliquots of the sample to be used to calculate the method detection limit and process each through the entire method, including blank measurements as described above in 4a. Evaluate these data:

(1) If these measurements indicate the sample is in desirable range for determination of the MDL, take five additional aliquots and proceed. Use all seven measurements for calculation of the MDL.

(2) If these measurements indicate the sample is not in correct range, reestimate the MDL, obtain new sample as in 3 and repeat either 4a or 4b.

5. Calculate the variance (S^2) and standard deviation (S) of the replicate measurements, as follows:

$$S^2 = \frac{1}{n-1} \left[\frac{\sum_{i=1}^n X_i^2 - \left(\frac{\sum_{i=1}^n X_i}{n} \right)^2}{n} \right]$$

$$s = (S^2)^{\frac{1}{2}}$$

where:

X_i ; $i=1$ to n , are the analytical results in the final method reporting units obtained from

Environmental Protection Agency

Pt. 136, App. B

the n sample aliquots and Σ refers to the sum of the X values from i=1 to n.

6. (a) Compute the MDL as follows:

$$MDL = T_{(n-1, 1-\alpha=0.99)} (S)$$

where:

MDL = the method detection limit

$t_{(n-1, 1-\alpha=0.99)}$ = the students' t value appropriate for a 99% confidence level and a standard deviation estimate with n-1 degrees of freedom. See Table.

S = standard deviation of the replicate analyses.

(b) The 95% confidence interval estimates for the MDL derived in 6a are computed according to the following equations derived from percentiles of the chi square over degrees of freedom distribution (χ^2/df).

LCL = 0.64 MDL

UCL = 2.20 MDL

where: LCL and UCL are the lower and upper 95% confidence limits respectively based on seven aliquots.

7. Optional iterative procedure to verify the reasonableness of the estimate of the MDL and subsequent MDL determinations.

(a) If this is the initial attempt to compute MDL based on the estimate of MDL formulated in Step 1, take the MDL as calculated in Step 6, spike the matrix at this calculated MDL and proceed through the procedure starting with Step 4.

(b) If this is the second or later iteration of the MDL calculation, use S^2 from the current MDL calculation and S^2 from the previous MDL calculation to compute the F-ratio. The F-ratio is calculated by substituting the larger S^2 into the numerator S^2_A and the other into the denominator S^2_B . The computed F-ratio is then compared with the F-ratio found in the table which is 3.05 as follows: if $S^2_A/S^2_B < 3.05$, then compute the pooled standard deviation by the following equation:

$$S_{\text{pooled}} = \left[\frac{6S_A^2 + 6S_B^2}{12} \right]^{1/2}$$

if $S^2_A/S^2_B > 3.05$, respike at the most recent calculated MDL and process the samples through the procedure starting with Step 4. If the most recent calculated MDL does not permit qualitative identification when samples are spiked at that level, report the MDL as a concentration between the current and previous MDL which permits qualitative identification.

(c) Use the S_{pooled} as calculated in 7b to compute The final MDL according to the following equation:

MDL=2.681 (S_{pooled})

where 2.681 is equal to $t_{(12, 1-\alpha=0.99)}$.

(d) The 95% confidence limits for MDL derived in 7c are computed according to the following equations derived from percentiles of the chi squared over degrees of freedom distribution.

LCL=0.72 MDL

UCL=1.65 MDL

where LCL and UCL are the lower and upper 95% confidence limits respectively based on 14 aliquots.

TABLES OF STUDENTS' T VALUES AT THE 99 PERCENT CONFIDENCE LEVEL

| Number of replicates | Degrees of freedom (n-1) | $t_{(n-1, .99)}$ |
|----------------------|--------------------------|------------------|
| 7 | 6 | 3.143 |

TABLES OF STUDENTS' T VALUES AT THE 99 PERCENT CONFIDENCE LEVEL—Continued

| Number of replicates | Degrees of freedom (n-1) | $t_{(n-1, .99)}$ |
|----------------------|--------------------------|------------------|
| 8 | 7 | 2.998 |
| 9 | 8 | 2.896 |
| 10 | 9 | 2.821 |
| 11 | 10 | 2.764 |
| 16 | 15 | 2.602 |
| 21 | 20 | 2.528 |
| 26 | 25 | 2.485 |
| 31 | 30 | 2.457 |
| 61 | 60 | 2.390 |
| 00 | 00 | 2.326 |

Reporting

The analytical method used must be specifically identified by number or title and the MDL for each analyte expressed in the appropriate method reporting units. If the analytical method permits options which affect the method detection limit, these conditions must be specified with the MDL value. The sample matrix used to determine the MDL must also be identified with MDL value. Report the mean analyte level with the MDL and indicate if the MDL procedure was iterated. If a laboratory standard or a sample that contained a known amount analyte was used for this determination, also report the mean recovery.

If the level of analyte in the sample was below the determined MDL or exceeds 10 times the MDL of the analyte in reagent water, do not report a value for the MDL.

[49 FR 43430, Oct. 26, 1984; 50 FR 694, 696, Jan. 4, 1985, as amended at 51 FR 23703, June 30, 1986]

APPENDIX C TO PART 136—INDUCTIVELY COUPLED PLASMA—ATOMIC EMISSION SPECTROMETRIC METHOD FOR TRACE ELEMENT ANALYSIS OF WATER AND WASTES METHOD 200.7

1. *Scope and Application*

1.1 This method may be used for the determination of dissolved, suspended, or total elements in drinking water, surface water, and domestic and industrial wastewaters.

1.2 Dissolved elements are determined in filtered and acidified samples. Appropriate steps must be taken in all analyses to ensure that potential interferences are taken into account. This is especially true when dissolved solids exceed 1500 mg/L. (See Section 5.)

1.3 Total elements are determined after appropriate digestion procedures are performed. Since digestion techniques increase the dissolved solids content of the samples, appropriate steps must be taken to correct for potential interference effects. (See Section 5.)

1.4 Table 1 lists elements for which this method applies along with recommended wavelengths and typical estimated instrumental detection limits using conventional pneumatic nebulization. Actual working detection limits are sample dependent and as the sample matrix varies, these concentrations may also vary. In time, other elements may be added as more information becomes available and as required.

1.5 Because of the differences between various makes and models of satisfactory instruments, no detailed instrumental operating instructions can be provided. Instead, the analyst is referred to the instruction provided by the manufacturer of the particular instrument.

2. *Summary of Method*

2.1 The method describes a technique for the simultaneous or sequential multielement determination of trace elements in solution. The basis of the method is the measurement of atomic emission by an optical spectroscopic technique. Samples are nebulized and the aerosol that is produced is transported to the plasma torch where excitation occurs. Characteristic atomic-line emission spectra are produced by a radio-frequency inductively coupled plasma (ICP). The spectra are dispersed by a grating spectrometer and the intensities of the lines are

monitored by photomultiplier tubes. The photocurrents from the photomultiplier tubes are processed and controlled by a computer system. A background correction technique is required to compensate for variable background contribution to the determination of trace elements. Background must be measured adjacent to analyte lines on samples during analysis. The position selected for the background intensity measurement, on either or both sides of the analytical line, will be determined by the complexity of the spectrum adjacent to the analyte line. The position used must be free of spectral interference and reflect the same change in background intensity as occurs at the analyte wavelength measured. Background correction is not required in cases of line broadening where a background correction measurement would actually degrade the analytical result. The possibility of additional interferences named in 5.1 (and tests for their presence as described in 5.2) should also be recognized and appropriate corrections made.

3. *Definitions*

3.1 *Dissolved*—Those elements which will pass through a 0.45 μm membrane filter.

3.2 *Suspended*—Those elements which are retained by a 0.45 μm membrane filter.

3.3 *Total*—The concentration determined on an unfiltered sample following vigorous digestion (Section 9.3), or the sum of the dissolved plus suspended concentrations. (Section 9.1 plus 9.2.)

3.4 *Total recoverable*—The concentration determined on an unfiltered sample following treatment with hot, dilute mineral acid (Section 9.4).

3.5 *Instrumental detection limit*—The concentration equivalent to a signal, due to the analyte, which is equal to three times the standard deviation of a series of ten replicate measurements of a reagent blank signal at the same wavelength.

3.6 *Sensitivity*—The slope of the analytical curve, *i.e.*, functional relationship between emission intensity and concentration.

3.7 *Instrument check standard*—A multielement standard of known concentrations prepared by the analyst to monitor and verify instrument performance on a daily basis. (See 7.6.1)

3.8 *Interference check sample*—A solution containing both interfering and analyte elements of known concentration that can be used to verify background and interelement correction factors. (See 7.6.2.)

3.9 *Quality control sample*—A solution obtained from an outside source having known, concentration values to be used to verify the calibration standards. (See 7.6.3)

3.10 *Calibration standards*—A series of known standard solutions used by the analyst for calibration of the instrument (*i.e.*, preparation of the analytical curve). (See 7.4)

3.11 *Linear dynamic range*—The concentration range over which the analytical curve remains linear.

3.12 *Reagent blank*—A volume of deionized, distilled water containing the same acid matrix as the calibration standards carried through the entire analytical scheme. (See 7.5.2)

3.13 *Calibration blank*—A volume of deionized, distilled water acidified with HNO₃ and HCl. (See 7.5.1)

3.14 *Method of standard addition*—The standard addition technique involves the use of the unknown and the unknown plus a known amount of standard. (See 10.6.1.)

4. Safety

4.1 The toxicity of carcinogenicity of each reagent used in this method has not been precisely defined; however, each chemical compound should be treated as a potential health hazard. From this viewpoint, exposure to these chemicals must be reduced to the lowest possible level by whatever means available. The laboratory is responsible for maintaining a current awareness file of OSHA regulations regarding the safe handling of the chemicals specified in this method. A reference file of material data handling sheets should also be made available to all personnel involved in the chemical analysis. Additional references to laboratory safety are available and have been identified^(14,7,14,8 and 14,9) for the information of the analyst.

5. Interferences

5.1 Several types of interference effects may contribute to inaccuracies in the determination of trace elements. They can be summarized as follows:

5.1.1 *Spectral interferences* can be categorized as (1) overlap of a spectral line from another element; (2) unresolved overlap of molecular band spectra; (3) background contribution from continuous or recombination phenomena; and (4) background contribution from stray light from the line emission of high concentration elements. The first of these effects can be compensated by utilizing a computer correction of the raw data, requiring the monitoring and measurement of the interfering element. The second effect may require selection of an alternate wavelength. The third and fourth effects can usually be compensated by a background correction adjacent to the analyte line. In addition, users of simultaneous multi-element instrumentation must assume the responsibility of verifying the absence of spectral interference from an element that could occur in a sample but for which there is no channel in the instrument array. Listed in Table 2 are some interference effects for the recommended wavelengths given in Table 1. The data in Table 2 are intended for use only as

a rudimentary guide for the indication of potential spectral interferences. For this purpose, linear relations between concentration and intensity for the analytes and the interferences can be assumed. The interference information, which was collected at the Ames Laboratory,¹ is expressed as analyte concentration equivalents (*i.e.*, false analyte concentrations) arising from 100 mg/L of the interferent element. The suggested use of this information is as follows: Assume that arsenic (at 193.696 nm) is to be determined in a sample containing approximately 10 mg/L of aluminum. According to Table 2, 100 mg/L of aluminum would yield a false signal for arsenic equivalent to approximately 1.3 mg/L. Therefore, 10 mg/L of aluminum would result in a false signal for arsenic equivalent to approximately 0.13 mg/L. The reader is cautioned that other analytical systems may exhibit somewhat different levels of interference than those shown in Table 2, and that the interference effects must be evaluated for each individual system.

Only those interferences listed were investigated and the blank spaces in Table 2 indicate that measurable interferences were not observed for the interferent concentrations listed in Table 3. Generally, interferences were discernible if they produced peaks or background shifts corresponding to 2-5% of the peaks generated by the analyte concentrations also listed in Table 3.

At present, information on the listed silver and potassium wavelengths are not available but it has been reported that second order energy from the magnesium 383.231 nm wavelength interferes with the listed potassium line at 766.491 nm.

5.1.2 *Physical interferences* are generally considered to be effects associated with the sample nebulization and transport processes. Such properties as change in viscosity and surface tension can cause significant inaccuracies especially in samples which may contain high dissolved solids and/or acid concentrations. The use of a peristaltic pump may lessen these interferences. If these types of interferences are operative, they must be reduced by dilution of the sample and/or utilization of standard addition techniques. Another problem which can occur from high dissolved solids is salt buildup at the tip of the nebulizer. This affects aerosol flow rate causing instrumental drift. Wetting the argon prior to nebulization, the use of a tip washer, or sample dilution have been used to control this problem. Also, it has been reported that better control of the argon flow rate improves instrument performance. This is accomplished with the use of mass flow controllers.

¹Ames Laboratory, USDOE, Iowa State University, Ames Iowa 50011.

5.1.3 *Chemical Interferences* are characterized by molecular compound formation, ionization effects and solute vaporization effects. Normally these effects are not pronounced with the ICP technique, however, if observed they can be minimized by careful selection of operating conditions (that is, incident power, observation position, and so forth), by buffering of the sample, by matrix matching, and by standard addition procedures. These types of interferences can be highly dependent on matrix type and the specific analyte element.

5.2 It is recommended that whenever a new or unusual sample matrix is encountered, a series of tests be performed prior to reporting concentration data for analyte elements. These tests, as outlined in 5.2.1 through 5.2.4, will ensure the analyst that neither positive nor negative interference effects are operative on any of the analyte elements thereby distorting the accuracy of the reported values.

5.2.1 *Serial dilution.* If the analyte concentration is sufficiently high (minimally a factor of 10 above the instrumental detection limit after dilution), an analysis of a dilution should agree within 5 percent of the original determination (or within some acceptable control limit (14.3) that has been established for that matrix.). If not, a chemical or physical interference effect should be suspected.

5.2.2 *Spike addition.* The recovery of a spike addition added at a minimum level of 10X the instrumental detection limit (maximum 100X) to the original determination should be recovered to within 90 to 110 percent or within the established control limit for that matrix. If not, a matrix effect should be suspected. The use of a standard addition analysis procedure can usually compensate for this effect.

Caution: The standard addition technique does not detect coincident spectral overlap. If suspected, use of computerized compensation, an alternate wavelength, or comparison with an alternate method is recommended (See 5.2.3).

5.2.3 *Comparison with alternate method of analysis.* When investigating a new sample matrix, comparison tests may be performed with other analytical techniques such as atomic absorption spectrometry, or other approved methodology.

5.2.4 *Wavelength scanning of analyte line region.* If the appropriate equipment is available, wavelength scanning can be performed to detect potential spectral interferences.

6. Apparatus

6.1 Inductively Coupled Plasma-Atomic Emission Spectrometer.

6.1.1 Computer controlled atomic emission spectrometer with background correction.

6.1.2 Radiofrequency generator.

6.1.3 Argon gas supply, welding grade or better.

6.2 Operating conditions—Because of the differences between various makes and models of satisfactory instruments, no detailed operating instructions can be provided. Instead, the analyst should follow the instructions provided by the manufacturer of the particular instrument. Sensitivity, instrumental detection limit, precision, linear dynamic range, and interference effects must be investigated and established for each individual analyte line on that particular instrument. It is the responsibility of the analyst to verify that the instrument configuration and operating conditions used satisfy the analytical requirements and to maintain quality control data confirming instrument performance and analytical results.

7. Reagents and Standards

7.1 Acids used in the preparation of standards and for sample processing must be ultra-high purity grade or equivalent. Redistilled acids are acceptable.

7.1.1 *Acetic acid*, conc. (sp gr 1.06).

7.1.2 *Hydrochloric acid*, conc. (sp gr 1.19).

7.1.3 *Hydrochloric acid*, (1+1): Add 500 mL conc. HCl (sp gr 1.19) to 400 mL deionized, distilled water and dilute to 1 liter.

7.1.4 *Nitric acid*, conc. (sp gr 1.41).

7.1.5 *Nitric acid*, (1+1): Add 500 mL conc. HNO₃ (sp gr 1.41) to 400 mL deionized, distilled water and dilute to 1 liter.

7.2 *Deionized, distilled water:* Prepare by passing distilled water through a mixed bed of cation and anion exchange resins. Use deionized, distilled water for the preparation of all reagents, calibration standards and as dilution water. The purity of this water must be equivalent to ASTM Type II reagent water of Specification D 1193 (14.6).

7.3 *Standard stock solutions* may be purchased or prepared from ultra high purity grade chemicals or metals. All salts must be dried for 1 h at 105°C unless otherwise specified.

(CAUTION: Many metal salts are extremely toxic and may be fatal if swallowed. Wash hands thoroughly after handling.)

Typical stock solution preparation procedures follow:

7.3.1 *Aluminum solution, stock*, 1 mL=100µg Al: Dissolve 0.100 g of aluminum metal in an acid mixture of 4 mL of (1+1) HCl and 1 mL of conc. HNO₃ in a beaker. Warm gently to effect solution. When solution is complete, transfer quantitatively to a liter flask add an additional 10 mL of (1+1) HCl and dilute to 1,000 mL with deionized, distilled water.

7.3.2 *Antimony solution stock*, 1 mL=100 µg Sb: Dissolve 0.2669 g K(SbO)₃·H₂O₆ in deionized distilled water, add 10 mL (1+1) HCl and dilute to 1,000 mL with deionized, distilled water.

7.3.3 *Arsenic solution, stock*, 1 mL=100 µg As: Dissolve 0.1320 g of As_2O_3 in 100 mL of deionized, distilled water containing 0.4 g NaOH. Acidify the solution with 2 mL conc. HNO_3 and dilute to 1,000 mL with deionized, distilled water.

7.3.4 *Barium solution, stock*, 1 mL=100 µg Ba: Dissolve 0.1516 g BaCl_2 (dried at 250 °C for 2 hrs) in 10 mL deionized, distilled water with 1 mL (1+1) HCl. Add 10.0 mL (1+1) HCl and dilute to 1,000 mL with deionized, distilled water.

7.3.5 *Beryllium solution, stock*, 1 mL=100 µg Be: *Do not dry*. Dissolve 1.966 g $\text{BeSO}_4 \cdot 4\text{H}_2\text{O}$ in deionized, distilled water, add 10.0 mL conc. HNO_3 and dilute to 1,000 mL with deionized, distilled water.

7.3.6 *Boron solution, stock*, 1 mL=100 µg B: *Do not dry*. Dissolve 0.5716 g anhydrous H_3BO_3 in deionized, distilled water and dilute to 1,000 mL. Use a reagent meeting ACS specifications, keep the bottle tightly stoppered and store in a desiccator to prevent the entrance of atmospheric moisture.

7.3.7 *Cadmium solution, stock*, 1 mL=100 µg Cd: Dissolve 0.1142 g CdO in a minimum amount of (1+1) HNO_3 . Heat to increase rate of dissolution. Add 10.0 mL conc. HNO_3 and dilute to 1,000 mL with deionized, distilled water.

7.3.8 *Calcium solution, stock*, 1 mL=100 µg Ca: Suspend 0.2498 g CaCO_3 dried at 180 °C for 1 h before weighing in deionized, distilled water and dissolve cautiously with a minimum amount of (1+1) HNO_3 . Add 10.0 mL conc. HNO_3 and dilute to 1,000 mL with deionized, distilled water.

7.3.9 *Chromium solution, stock*, 1 mL=100 µg Cr: Dissolve 0.1923 g of CrO_3 in deionized, distilled water. When solution is complete, acidify with 10 mL conc. HNO_3 and dilute to 1,000 mL with deionized, distilled water.

7.3.10 *Cobalt solution, stock*, 1 mL=100 µg Co: Dissolve 0.1000 g of cobalt metal in a minimum amount of (1+1) HNO_3 . Add 10.0 mL (1+1) HCl and dilute to 1,000 mL with deionized, distilled water.

7.3.11 *Copper solution, stock*, 1 mL=100 µg Cu: Dissolve 0.1252 g CuO in a minimum amount of (1+1) HNO_3 . Add 10.0 mL conc. HNO_3 and dilute to 1,000 mL with deionized, distilled water.

7.3.12 *Iron solution, stock*, 1 mL=100 µg Fe: Dissolve 0.1430 g Fe_2O_3 in a warm mixture of 20 mL (1+1) HCl and 2 mL of conc. HNO_3 . Cool, add an additional 5 mL of conc. HNO_3 and dilute to 1,000 mL with deionized, distilled water.

7.3.13 *Lead solution, stock*, 1 mL=100 µg Pb: Dissolve 0.1599 g $\text{Pb}(\text{NO}_3)_2$ in a minimum amount of (1+1) HNO_3 . Add 10.0 mL conc. HNO_3 and dilute to 1,000 mL with deionized, distilled water.

7.3.14 *Magnesium solution, stock*, 1 mL=100 µg Mg: Dissolve 0.1658 g MgO in a minimum amount of (1+1) HNO_3 . Add 10.0 mL conc.

HNO_3 and dilute to 1,000 mL with deionized, distilled water.

7.3.15 *Manganese solution, stock*, 1 mL=100 µg Mn: Dissolve 0.1000 g of manganese metal in the acid mixture 10 mL conc. HCl and 1 mL conc. HNO_3 , and dilute to 1,000 mL with deionized, distilled water.

7.3.16 *Molybdenum solution, stock*, 1 mL=100 µg Mo: Dissolve 0.2043 g $(\text{NH}_4)_2\text{MoO}_4$ in deionized, distilled water and dilute to 1,000 mL.

7.3.17 *Nickel solution, stock*, 1 mL=100 µg Ni: Dissolve 0.1000 g of nickel metal in 10 mL hot conc. HNO_3 , cool and dilute to 1,000 mL with deionized, distilled water.

7.3.18 *Potassium solution, stock*, 1 mL=100 µg K: Dissolve 0.1907 g KCl, dried at 110 °C, in deionized, distilled water and dilute to 1,000 mL.

7.3.19 *Selenium solution, stock*, 1 mL=100 µg Se: *Do not dry*. Dissolve 0.1727 g H_2SeO_3 (actual assay 94.6%) in deionized, distilled water and dilute to 1,000 mL.

7.3.20 *Silica solution, stock*, 1 mL=100 µg SiO_2 : *Do not dry*. Dissolve 0.4730 g $\text{Na}_2\text{SiO}_3 \cdot 9\text{H}_2\text{O}$ in deionized, distilled water. Add 10.0 mL conc. HNO_3 and dilute to 1,000 mL with deionized, distilled water.

7.3.21 *Silver solution, stock*, 1 mL=100 µg Ag: Dissolve 0.1575 g AgNO_3 in 100 mL of deionized, distilled water and 10 mL conc. HNO_3 . Dilute to 1,000 mL with deionized, distilled water.

7.3.22 *Sodium solution, stock*, 1 mL=100 µg Na: Dissolve 0.2542 g NaCl in deionized, distilled water. Add 10.0 mL conc. HNO_3 and dilute to 1,000 mL with deionized, distilled water.

7.3.23 *Thallium solution, stock*, 1 mL=100 µg Tl: Dissolve 0.1303 g TlNO_3 in deionized, distilled water. Add 10.0 mL conc. HNO_3 and dilute to 1,000 mL with deionized, distilled water.

7.3.24 *Vanadium solution, stock*, 1 mL=100 µg V: Dissolve 0.2297 NH_4VO_3 in a minimum amount of conc. HNO_3 . Heat to increase rate of dissolution. Add 10.0 mL conc. HNO_3 and dilute to 1,000 mL with deionized, distilled water.

7.3.25 *Zinc solution, stock*, 1 mL=100 µg Zn: Dissolve 0.1245 g ZnO in a minimum amount of dilute HNO_3 . Add 10.0 mL conc. HNO_3 and dilute to 1,000 mL deionized, distilled water.

7.4 *Mixed calibration standard solutions*—Prepare mixed calibration standard solutions by combining appropriate volumes of the stock solutions in volumetric flasks. (See 7.4.1 thru 7.4.5) Add 2 mL of (1+1) HNO_3 and 10 mL of (1+1) HCl and dilute to 100 mL with deionized, distilled water. (See Notes 1 and 6.) Prior to preparing the mixed standards, each stock solution should be analyzed separately to determine possible spectral interference or the presence of impurities. Care should be taken when preparing the

mixed standards that the elements are compatible and stable. Transfer the mixed standard solutions to a FEP fluorocarbon or unused polyethylene bottle for storage. Fresh mixed standards should be prepared as needed with the realization that concentration can change on aging. Calibration standards must be initially verified using a quality control sample and monitored weekly for stability (See 7.6.3). Although not specifically required, some typical calibration standard combinations follow when using those specific wavelengths listed in Table 1.

7.4.1 *Mixed standard solution I*—Manganese, beryllium, cadmium, lead, and zinc.

7.4.2 *Mixed standard solution II*—Barium, copper, iron, vanadium, and cobalt.

7.4.3 *Mixed standard solution III*—Molybdenum, silica, arsenic, and selenium.

7.4.4 *Mixed standard solution IV*—Calcium, sodium, potassium, aluminum, chromium and nickel.

7.4.5 *Mixed standard solution V*—Antimony, boron, magnesium, silver, and thallium.

NOTE: 1. If the addition of silver to the recommended acid combination results in an initial precipitation, add 15 mL of deionized distilled water and warm the flask until the solution clears. Cool and dilute to 100 mL with deionized, distilled water. For this acid combination the silver concentration should be limited to 2 mg/L. Silver under these conditions is stable in a tap water matrix for 30 days. Higher concentrations of silver require additional HCl.

7.5 Two types of blanks are required for the analysis. The calibration blank (3.13) is used in establishing the analytical curve while the reagent blank (3.12) is used to correct for possible contamination resulting from varying amounts of the acids used in the sample processing.

7.5.1 *The calibration blank* is prepared by diluting 2 mL of (1+1) HNO₃ and 10 mL of (1+1) HCl to 100 mL with deionized, distilled water. (See Note 6.) Prepare a sufficient quantity to be used to flush the system between standards and samples.

7.5.2 *The reagent blank* must contain all the reagents and in the same volumes as used in the processing of the samples. The reagent blank must be carried through the complete procedure and contain the same acid concentration in the final solution as the sample solution used for analysis.

7.6 In addition to the calibration standards, an instrument check standard (3.7), an interference check sample (3.8) and a quality control sample (3.9) are also required for the analyses.

7.6.1 *The instrument check standard* is prepared by the analyst by combining compatible elements at a concentration equivalent to the midpoint of their respective calibration curves. (See 12.1.1.)

7.6.2 *The interference check sample* is prepared by the analyst in the following manner. Select a representative sample which contains minimal concentrations of the analytes of interest but known concentration of interfering elements that will provide an adequate test of the correction factors. Spike the sample with the elements of interest at the approximate concentration of either 100 µg/L or 5 times the estimated detection limits given in Table 1. (For effluent samples of expected high concentrations, spike at an appropriate level.) If the type of samples analyzed are varied, a synthetically prepared sample may be used if the above criteria and intent are met.

7.6.3 *The quality control sample* should be prepared in the same acid matrix as the calibration standards at a concentration near 1 mg/L and in accordance with the instructions provided by the supplier. The Quality Assurance Branch of EMSL-Cincinnati will either supply a quality control sample or information where one of equal quality can be procured. (See 12.1.3.)

8. Sample Handling and Preservation

8.1 For the determination of trace elements, contamination and loss are of prime concern. Dust in the laboratory environment, impurities in reagents and impurities on laboratory apparatus which the sample contacts are all sources of potential contamination. Sample containers can introduce either positive or negative errors in the measurement of trace elements by (a) contributing contaminants through leaching or surface desorption and (b) by depleting concentrations through adsorption. Thus the collection and treatment of the sample prior to analysis requires particular attention. Laboratory glassware including the sample bottle (whether polyethylene, polypropylene or FEP-fluorocarbon) should be thoroughly washed with detergent and tap water; rinsed with (1+1) nitric acid, tap water, (1+1) hydrochloric acid, tap and finally deionized, distilled water in that order (See Notes 2 and 3).

NOTE: 2. Chromic acid may be useful to remove organic deposits from glassware; however, the analyst should be cautioned that the glassware must be thoroughly rinsed with water to remove the last traces of chromium. This is especially important if chromium is to be included in the analytical scheme. A commercial product, NOCHROMIX, available from Godax Laboratories, 6 Varick St., New York, NY 10013, may be used in place of chromic acid. Chromic acid should not be used with plastic bottles.

NOTE: 3. If it can be documented through an active analytical quality control program using spiked samples and reagent blanks, that certain steps in the cleaning procedure

are not required for routine samples, those steps may be eliminated from the procedure.

8.2 Before collection of the sample a decision must be made as to the type of data desired, that is dissolved, suspended or total, so that the appropriate preservation and pretreatment steps may be accomplished. Filtration, acid preservation, etc., are to be performed at the time the sample is collected or as soon as possible thereafter.

8.2.1 For the determination of dissolved elements the sample must be filtered through a 0.45- μ m membrane filter as soon as practical after collection. (Glass or plastic filtering apparatus are recommended to avoid possible contamination.) Use the first 50–100 mL to rinse the filter flask. Discard this portion and collect the required volume of filtrate. Acidify the filtrate with (1+1) HNO_3 to a pH of 2 or less. Normally, 3 mL of (1+1) acid per liter should be sufficient to preserve the sample.

8.2.2 For the determination of suspended elements a measured volume of unpreserved sample must be filtered through a 0.45- μ m membrane filter as soon as practical after collection. The filter plus suspended material should be transferred to a suitable container for storage and/or shipment. No preservative is required.

8.2.3 For the determination of total or total recoverable elements, the sample is acidified with (1+1) HNO_3 to pH 2 or less as soon as possible, preferably at the time of collection. The sample is not filtered before processing.

9. Sample Preparation

9.1 For the determinations of dissolved elements, the filtered, preserved sample may often be analyzed as received. The acid matrix and concentration of the samples and calibration standards must be the same. (See Note 6.) If a precipitate formed upon acidification of the sample or during transit or storage, it must be redissolved before the analysis by adding additional acid and/or by heat as described in 9.3.

9.2 For the determination of suspended elements, transfer the membrane filter containing the insoluble material to a 150-mL Griffin beaker and add 4 mL conc. HNO_3 . Cover the beaker with a watch glass and heat gently. The warm acid will soon dissolve the membrane. Increase the temperature of the hot plate and digest the material. When the acid has nearly evaporated, cool the beaker and watch glass and add another 3 mL of conc. HNO_3 . Cover and continue heating until the digestion is complete, generally indicated by a light colored digestate. Evaporate to near dryness (2 mL), cool, and 10 mL HCl (1+1) and 15 mL deionized, distilled water per 100 mL dilution and warm the beaker gently for 15 min. to dissolve any precipitated or residue material. Allow to

cool, wash down the watch glass and beaker walls with deionized distilled water and filter the sample to remove insoluble material that could clog the nebulizer. (See Note 4.) Adjust the volume based on the expected concentrations of elements present. This volume will vary depending on the elements to be determined (See Note 6). The sample is now ready for analysis. Concentrations so determined shall be reported as "suspended."

NOTE: 4. In place of filtering, the sample after diluting and mixing may be centrifuged or allowed to settle by gravity overnight to remove insoluble material.

9.3 For the determination of total elements, choose a measured volume of the well mixed acid preserved sample appropriate for the expected level of elements and transfer to a Griffin beaker. (See Note 5.) Add 3 mL of conc. HNO_3 . Place the beaker on a hot plate and evaporate to near dryness cautiously, making certain that the sample does not boil and that no area of the bottom of the beaker is allowed to go dry. Cool the beaker and add another 5 mL portion of conc. HNO_3 . Cover the beaker with a watch glass and return to the hot plate. Increase the temperature of the hot plate so that a gently reflux action occurs. Continue heating, adding additional acid as necessary, until the digestion is complete (generally indicated when the digestate is light in color or does not change in appearance with continued refluxing.) Again, evaporate to near dryness and cool the beaker. Add 10 mL of 1+1 HCl and 15 mL of deionized, distilled water per 100 mL of final solution and warm the beaker gently for 15 min. to dissolve any precipitate or residue resulting from evaporation. Allow to cool, wash down the beaker walls and watch glass with deionized distilled water and filter the sample to remove insoluble material that could clog the nebulizer. (See Note 4.) Adjust the sample to a predetermined volume based on the expected concentrations of elements present. The sample is now ready for analysis (See Note 6). Concentrations so determined shall be reported as "total."

NOTE: 5. If low determinations of boron are critical, quartz glassware should be used.

NOTE: 6. If the sample analysis solution has a different acid concentration from that given in 9.4, but does not introduce a physical interference or affect the analytical result, the same calibration standards may be used.

9.4 For the determination of total recoverable elements, choose a measured volume of a well mixed, acid preserved sample appropriate for the expected level of elements and transfer to a Griffin beaker. (See Note 5.) Add 2 mL of (1+1) HNO_3 and 10 mL of (1+1) HCl to the sample and heat on a steam bath

or hot plate until the volume has been reduced to near 25 mL making certain the sample does not boil. After this treatment, cool the sample and filter to remove insoluble material that could clog the nebulizer. (See Note 4.) Adjust the volume to 100 mL and mix. The sample is now ready for analysis. Concentrations so determined shall be reported as "total."

10. Procedure

10.1 Set up instrument with proper operating parameters established in Section 6.2. The instrument must be allowed to become thermally stable before beginning. This usually requires at least 30 min. of operation prior to calibration.

10.2 Initiate appropriate operating configuration of computer.

10.3 Profile and calibrate instrument according to instrument manufacturer's recommended procedures, using the typical mixed calibration standard solutions described in Section 7.4. Flush the system with the calibration blank (7.5.1) between each standard. (See Note 7.) (The use of the average intensity of multiple exposures for both standardization and sample analysis has been found to reduce random error.)

NOTE: 7. For boron concentrations greater than 500 µg/L extended flush times of 1 to 2 minutes may be required.

10.4 Before beginning the sample run, re-analyze the highest mixed calibration standard as if it were a sample. Concentration values obtained should not deviate from the actual values by more than ±5 percent (or the established control limits whichever is lower). If they do, follow the recommendations of the instrument manufacturer to correct for this condition.

10.5 Begin the sample run flushing the system with the calibration blank solution (7.5.1) between each sample. (See Note 7.) Analyze the instrument check standard (7.6.1) and the calibration blank (7.5.1) each 10 samples.

10.6 If it has been found that methods of standard addition are required, the following procedure is recommended.

10.6.1 The standard addition technique (14.2) involves preparing new standards in the sample matrix by adding known amounts of standard to one or more aliquots of the processed sample solution. This technique compensates for a sample constituent that enhances or depresses the analyte signal thus producing a different slope from that of the calibration standards. It will not correct for additive interference which causes a baseline shift. The simplest version of this technique is the single-addition method. The procedure is as follows. Two identical aliquots of the sample solution, each of volume V_x , are taken. To the first (labeled A) is added a small volume V_s of a standard

analyte solution of concentration c_s . To the second (labeled B) is added the same volume V_s of the solvent. The analytical signals of A and B are measured and corrected for nonanalyte signals. The unknown sample concentration c_x is calculated:

$$c_x = \frac{S_B V_s c_s}{(S_A - S_B) V_x}$$

where S_A and S_B are the analytical signals (corrected for the blank) of solutions A and B, respectively. V_s and c_s should be chosen so that S_A is roughly twice S_B on the average. It is best if V_s is made much less than V_x , and thus c_s is much greater than c_x , to avoid excess dilution of the sample matrix. If a separation or concentration step is used, the additions are best made first and carried through the entire procedure. For the results from this technique to be valid, the following limitations must be taken into consideration:

1. The analytical curve must be linear.
2. The chemical form of the analyte added must respond the same as the analyte in the sample.
3. The interference effect must be constant over the working range of concern.
4. The signal must be corrected for any additive interference.

11. Calculation

11.1 Reagent blanks (7.5.2) should be subtracted from all samples. This is particularly important for digested samples requiring large quantities of acids to complete the digestion.

11.2 If dilutions were performed, the appropriate factor must be applied to sample values.

11.3 Data should be rounded to the thousandth place and all results should be reported in mg/L up to three significant figures.

12. Quality Control (Instrumental)

12.1 Check the instrument standardization by analyzing appropriate quality control check standards as follow:

12.1.1 Analyze and appropriate instrument check standard (7.6.1) containing the elements of interest at a frequency of 10%. This check standard is used to determine instrument drift. If agreement is not within ±5% of the expected values or within the established control limits, whichever is lower, the analysis is out of control. The analysis should be terminated, the problem corrected, and the instrument recalibrated.

Analyze the calibration blank (7.5.1) at a frequency of 10%. The result should be within the established control limits of 2 standard deviations of the mean value. If not, repeat the analysis two more times and average the three results. If the average is not within the control limit, terminate the analysis, correct the problem and recalibrate the instrument.

12.1.2 To verify interelement and background correction factors analyze the interference check sample (7.6.2) at the beginning, end, and at periodic intervals throughout the sample run. Results should fall within the established control limits of 1.5 times the standard deviation of the mean value. If not, terminate the analysis, correct the problem and recalibrate the instrument.

12.1.3 A quality control sample (7.6.3) obtained from an outside source must first be used for the initial verification of the calibration standards. A fresh dilution of this sample shall be analyzed every week thereafter to monitor their stability. If the results are not within $\pm 5\%$ of the true value listed for the control sample, prepare a new calibration standard and recalibrate the instrument. If this does not correct the problem, prepare a new stock standard and a new calibration standard and repeat the calibration.

13. Precision and Accuracy

13.1 An interlaboratory study of metal analyses by this method was conducted by the Quality Assurance Branch (QAB) of the Environmental Monitoring Systems Laboratory—Cincinnati (EMSL-CI). Synthetic concentrates containing various levels of the twenty-five elements listed in Table 4 were added to reagent water, surface water, drinking water and three effluents. These samples were digested by both the total digestion procedure (9.3) and the total recoverable procedure (9.4). Results for both digestions for the twenty-five elements in reagent water are given in Table 4; results for the other matrices can be found in Reference 14.10.

14. References

14.1 Winge, R.K., V.J. Peterson, and V.A. Fassel, "Inductively Coupled Plasma-Atomic Emission Spectroscopy: Prominent Lines," EPA-600/4-79-017.

14.2 Winefordner, J.D., "Trace Analysis: Spectroscopic Methods for Elements," *Chemical Analysis*, Vol. 46, pp. 41-42.

14.3 Handbook for Analytical Quality Control in Water and Wastewater Laboratories, EPA-600/4-79-019.

14.4 Garbarino, J.R. and Taylor, H.E., "An Inductively-Coupled Plasma Atomic Emission Spectrometric Method for Routine

Water Quality Testing," *Applied Spectroscopy* 33, No. 3 (1979).

14.5 "Methods for Chemical Analysis of Water and Wastes," EPA-600/4-79-020.

14.6 Annual Book of ASTM Standards, Part 31.

14.7 "Carcinogens—Working With Carcinogens," Department of Health, Education, and Welfare, Public Health Service, Center for Disease Control, National Institute for Occupational Safety and Health, Publication No. 77-206, August 1977.

14.8 "OSHA Safety and Health Standards, General Industry," (29 CFR Part 1910), Occupational Safety and Health Administration, OSHA 2206, (Revised, January 1976).

14.9 "Safety in Academic Chemistry Laboratories, American Chemical Society Publication, Committee on Chemical Safety, 3rd Edition, 1979.

14.10 Maxfield R. and Minak B., "EPA Method Study 27, Method 200.7 Trace Metals by ICP," National Technical Information Service, Order No. PB 85-248-656, November 1983.

TABLE 1—RECOMMENDED WAVELENGTHS¹ AND ESTIMATED INSTRUMENTAL DETECTION LIMITS

| Element | Wave-length, nm | Estimated detection limit, $\mu\text{g/L}^2$ |
|----------------------------------|-----------------|--|
| Aluminum | 308.215 | 45 |
| Arsenic | 193.696 | 53 |
| Antimony | 206.833 | 32 |
| Barium | 455.403 | 2 |
| Beryllium | 313.042 | 0.3 |
| Boron | 249.773 | 5 |
| Cadmium | 226.502 | 4 |
| Calcium | 317.933 | 10 |
| Chromium | 267.716 | 7 |
| Cobalt | 228.616 | 7 |
| Copper | 324.754 | 6 |
| Iron | 259.940 | 7 |
| Lead | 220.353 | 42 |
| Magnesium | 279.079 | 30 |
| Manganese | 257.610 | 2 |
| Molybdenum | 202.030 | 8 |
| Nickel | 231.604 | 15 |
| Potassium | 766.491 | ³ |
| Selenium | 196.026 | 75 |
| Silica (SiO ₂) | 288.158 | 58 |
| Silver | 328.068 | 7 |
| Sodium | 588.995 | 29 |
| Thallium | 190.864 | 40 |
| Vanadium | 292.402 | 8 |
| Zinc | 213.856 | 2 |

¹The wavelengths listed are recommended because of their sensitivity and overall acceptance. Other wavelengths may be substituted if they can provide the needed sensitivity and are treated with the same corrective techniques for spectral interference. (See 5.1.1).

²The estimated instrumental detection limits as shown are taken from "Inductively Coupled Plasma-Atomic Emission Spectroscopy-Prominent Lines," EPA-600/4-79-017. They are given as a guide for an instrumental limit. The actual method detection limits are sample dependent and may vary as the sample matrix varies.

³Highly dependent on operating conditions and plasma position.

TABLE 1—ANALYTE CONCENTRATION EQUIVALENTS (MG/L) ARISING FROM INTERFERENTS AT THE 100 MG/L LEVEL

| Analyte | Wave-length, nm | Interferent— | | | | | | | | | |
|------------|-----------------|--------------|------|------|------|-------|-------|------|------|------|------|
| | | A1 | Ca | Cr | Cu | Fe | Mg | Mn | Ni | Ti | V |
| Aluminum | 308.214 | | | | | | | 0.21 | | | 1.4 |
| Antimony | 206.833 | 0.47 | | | | 0.08 | | | | 0.25 | 0.45 |
| Arsenic | 193.696 | 1.3 | | 0.44 | | | | | | | 1.1 |
| Barium | 455.403 | | | | | | | | | | |
| Beryllium | 313.042 | | | | | | | | | 0.04 | 0.05 |
| Boron | 249.773 | 0.04 | | | | 0.32 | | | | | |
| Cadmium | 226.502 | | | | | 0.03 | | | 0.02 | | |
| Calcium | 317.933 | | | 0.08 | | 0.01 | 0.01 | 0.04 | | 0.03 | 0.03 |
| Chromium | 267.716 | | | | | 0.003 | | 0.04 | | | 0.04 |
| Cobalt | 228.616 | | | 0.03 | | 0.005 | | | 0.03 | 0.15 | |
| Copper | 324.754 | | | | | 0.003 | | | | 0.05 | 0.02 |
| Iron | 259.940 | | | | | | | 0.12 | | | |
| Lead | 220.353 | 0.17 | | | | | | | | | |
| Magnesium | 279.079 | | 0.02 | 0.11 | | 0.13 | | 0.25 | | 0.07 | 0.12 |
| Manganese | 257.610 | 0.005 | | 0.01 | | 0.002 | 0.002 | | | | |
| Molybdenum | 202.030 | 0.05 | | | | 0.03 | | | | | |
| Nickel | 231.604 | | | | | | | | | | |
| Selenium | 196.026 | 0.23 | | | | 0.09 | | | | | |
| Silicon | 288.158 | | | 0.07 | | | | | | | 0.01 |
| Sodium | 588.995 | | | | | | | | | 0.08 | |
| Thallium | 190.864 | 0.30 | | | | | | | | | |
| Vanadium | 292.402 | | | 0.05 | | 0.005 | | | | 0.02 | |
| Zinc | 213.856 | | | | 0.14 | | | | 0.29 | | |

TABLE 3—INTERFERENT AND ANALYTE ELEMENTAL CONCENTRATIONS USED FOR INTERFERENCE MEASUREMENTS IN TABLE 2

| Analytes | | (mg/L) | Interferents | | (mg/L) |
|----------|-------|--------|--------------|-------|--------|
| Al | | 10 | Al | | 1,000 |
| AS | | 10 | Ca | | 1,000 |
| B | | 10 | Cr | | 200 |
| Ba | | 1 | Cu | | 200 |
| Be | | 1 | Fe | | 1,000 |
| Ca | | 1 | Mg | | 1,000 |
| Cd | | 10 | Mn | | 200 |
| Co | | 1 | Ni | | 200 |
| Cr | | 1 | Ti | | 200 |
| Cu | | 1 | V | | 200 |
| Fe | | 1 | | | |
| Mg | | 1 | | | |
| Mn | | 1 | | | |
| Mo | | 10 | | | |
| Na | | 10 | | | |
| Ni | | 10 | | | |
| Pb | | 10 | | | |
| Sb | | 10 | | | |
| Se | | 10 | | | |
| Si | | 1 | | | |
| Tl | | 10 | | | |
| V | | 1 | | | |
| Zn | | 10 | | | |

TABLE 4—ICP PRECISION AND RECOVERY DATA

| Analyte | Concentration µg/L | Total digestion (9.3) µg/L | Recoverable digestion (9.4) µg/L |
|----------|--------------------|---|---|
| Aluminum | 69-4792 | X=0.9273(C)+3.6 S=0.0559(X)+18.6 SR=0.0507(X)+3.5 | X=0.9380(C)+22.1 S=0.0873(X)+31.7 SR=0.0481(X)+18.8 |
| Antimony | 77-1406 | X=0.7940(C) - 17.0 S=0.1556(X) - 0.6 SR=0.1081(X)+3.9 | X=0.8908(C)+0.9 S=0.0982(X)+8.3 SR=0.0682(X)+2.5 |
| Arsenic | 69-1887 | X=1.0437(C) - 12.2 S=0.1239(X)+2.4 SR=0.0874(X)+6.4 | X=1.0175(C)+3.9 S=0.1288(X)+6.1 SR=0.0643(X)+10.3 |

TABLE 4—ICP PRECISION AND RECOVERY DATA—Continued

| Analyte | Concentration µg/L | Total digestion (9.3) µg/L | Recoverable digestion (9.4) µg/L |
|------------------|-----------------------|---|---|
| Barium | 9-377 | X=0.7683(C)+0.47 S=0.1819(X)+2.78 SR=0.1285(X)+2.55 | X=0.8380(C)+1.68 S=0.2540(X)+0.30 SR=0.0826(X)+3.54 |
| Beryllium | 3-1906 | X=0.9629(C)+0.05 S=0.0136(X)+0.95 SR=0.0203(X) - 0.07 | X=1.0177(C) - 0.55 S=0.0359(X)+0.90 SR=0.0445(X) - 0.10 |
| Boron | 19-5189 | X=0.8807(C)+9.0 S=0.1150(X)+14.1 SR=0.0742(X)+23.2 | X=0.9676(C)+18.7 S=0.1320(X)+16.0 SR=0.0743(X)+21.1 |
| Cadmium | 9-1943 | X=0.9874(C) - 0.18 S=0.557(X)+2.02 SR=0.0300(X)+0.94 | X=1.0137(C) - 0.65 S=0.0585(X)+1.15 SR=0.332(X)+0.90 |
| Calcium | 17-47170 | X=0.9182(C) - 2.6 S=0.1228(X)+10.1 SR=0.0189(X)+3.7 | X=0.9658(C)+0.8 S=0.0917(X)+6.9 SR=0.0327(X)+10.1 |
| Chromium | 13-1406 | X=0.9544(C)+3.1 S=0.0499(X)+4.4 SR=0.0009(X)+7.9 | X=1.0049(C) - 1.2 S=0.0698(X)+2.8 SR=0.0571(X)+1.0 |
| Cobalt | 17-2340 | X=0.9209(C) - 4.5 S=0.0436(X)+3.8 SR=0.0428(X)+0.5 | X=0.9278(C) - 1.5 S=0.0498(X)+2.6 SR=0.0407(X)+0.4 |
| Copper | 8-1887 | X=0.9297(C) - 0.30 S=0.0442(X)+2.85 SR=0.0128(X)+2.53 | X=0.9647(C) - 3.64 S=0.0497(X)+2.28 SR=0.0406(X)+0.96 |
| Iron | 13-9359 | X=0.8829(C)+7.0 S=0.0683(X)+11.5 SR=0.0046(X)+10.0 | X=0.9830(C)+5.7 S=0.1024(X)+13.0 SR=0.0790(X)+11.5 |
| Lead | 42-4717 | X=0.9699(C) - 2.2 S=0.0558(X)+7.0 SR=0.0353(X)+3.6 | X=1.0056(C)+4.1 S=0.0779(X)+4.6 SR=0.0448(X)+3.5 |
| Magnesium | 34-13868 | X=0.9881(C) - 1.1 S=0.0607(C)+11.6 SR=0.0298(X)+0.6 | X=0.9879(C)+2.2 S=0.0564(X)+13.2 SR=0.0268(X)+8.1 |
| Manganese | 4-1887 | X=0.9417(C)+0.13 S=0.0324(X)+0.88 SR=0.0153(X)+0.91 | X=0.9725(C)+0.07 S=0.0557(X)+0.76 SR=0.0400(X)+0.82 |
| Molybdenum | 17-1830 | X=0.9682(C)+0.1 S=0.0618(X)+1.6 SR=0.0371(X)+2.2 | X=0.9707(C) - 2.3 S=0.0811(X)+3.8 SR=0.0529(X)+2.1 |
| Nickel | 17-47170 | X=0.9508(C)+0.4 S=0.0604(X)+4.4 SR=0.0425(X)+3.6 | X=0.9869(C)+1.5 S=0.0526(X)+5.5 SR=0.0393(X)+2.2 |
| Potassium | 347-14151 | X=0.8669(C) - 36.4 S=0.0934(X)+77.8 SR=0.0099(X)+144.2 | X=0.9355(C) - 183.1 S=0.0481(X)+177.2 SR=0.0329(X)+60.9 |
| Selenium | 69-1415 | X=0.9363(C) - 2.5 S=0.0855(X)+17.8 SR=0.0284(X)+9.3 | X=0.9737(C) - 1.0 S=0.1523(X)+7.8 SR=0.0443(X)+6.6 |
| Silicon | 189-9434 | X=0.5742(C) - 35.6 S=0.4160(X)+37.8 SR=0.1987(X)+8.4 | X=0.9737(C) - 60.8 S=0.3288(X)+46.0 SR=0.2133(X)+22.6 |
| Silver | 8-189 | X=0.4466(C)+5.07 S=0.5055(X) - 3.05 SR=0.2086(X) - 1.74 | X=0.3987(C)+8.25 S=0.5478(X) - 3.93 SR=0.1836(X) - 0.27 |
| Sodium | 35-47170 | X=0.9581(C)+39.6 S=0.2097(X)+33.0 SR=0.0280(X)+105.8 | X=1.0526(C)+26.7 S=0.1473(X)+27.4 SR=0.0884(X)+50.5 |
| Thallium | 79-1434 | X=0.9020(C) - 7.3 S=0.1004(X)+18.3 SR=0.0364(X)+11.5 | X=0.9238(C)+5.5 S=0.2156(X)+5.7 SR=0.0106(X)+48.0 |
| Vanadium | 13-4698 | X=0.9615(C) - 2.0 S=0.0618(X)+1.7 SR=0.0220(X)+0.7 | X=0.9551(C)+0.4 S=0.0927(X)+1.6 SR=0.0472(X)+0.5 |
| Zinc | 7-7076 | X=0.9356(C) - 0.30 S=0.0914(X)+3.75 SR=0.0130(X)+10.7 | X=0.9500(C)+1.82 S=0.0597(X)+6.50 SR=0.0153(X)+7.78 |

AAAAAX=Mean Recovery, µg/L
 AAAAAC=True Value for the Concentration, µg/L
 AAAAAS=Multi-laboratory Standard Deviation, µg/L
 SR=Single-analyst Standard Deviation, µg/L

[49 FR 43431, Oct. 26, 1984; 50 FR 695, 696, Jan. 4, 1985, as amended at 51 FR 23703, June 30, 1986; 55 FR 33440, Aug. 15, 1990]

APPENDIX D TO PART 136—PRECISION AND RECOVERY STATEMENTS FOR METHODS FOR MEASURING METALS

Twenty-eight selected methods from "Methods for Chemical Analysis of Water and Wastes," EPA-600/4-79-020 (1979) have been subjected to interlaboratory method validation studies. The following precision and recovery statements are presented in this appendix and incorporated into part 136:

Method 202.1

For Aluminum, Method 202.1 (Atomic Absorption, Direct Aspiration) replace the Precision and Accuracy Section with the following:

Precision and Accuracy

An interlaboratory study on metal analyses by this method was conducted by the Quality Assurance Branch (QAB) of the Environmental Monitoring Systems Laboratory—Cincinnati (EMSL-CI). Synthetic concentrates containing various levels of this element were added to reagent water and a natural water or effluent of the analyst's choice. The digestion procedure was not specified. Results for the reagent water are given below. Results for other water types and study details are found in "USEPA Method Study 7, Analyses for Trace Methods in Water by Atomic Absorption Spectroscopy (Direct Aspiration) and Colorimetry", National Technical Information Service, 5285 Port Royal Road, Springfield, VA 22161, Order No. PB86-208709/AS, Winter, J.A. and Britton, P.W., June, 1986.

For a concentration range of 500-1200 µg/L
 $X=0.979(C)+6.16$
 $S=0.066(X)+125$
 $SR=0.086(X)+40.5$

where:

C=True Value for the Concentration, µg/L
 X=Mean Recovery, µg/L
 S=Multi-laboratory Standard Deviation, µg/L
 SR=Single-analyst Standard Deviation, µg/L

Method 206.4

For Arsenic, Method 206.4 (Spectrophotometric-SDDC) add the following to the Precision and Accuracy Section:

Precision and Accuracy

An interlaboratory study on metal analyses by this method was conducted by the Quality Assurance Branch (QAB) of the Environmental Monitoring Systems Laboratory—Cincinnati (EMSL-CI). Synthetic con-

centrates containing various levels of this element were added to reagent water and a natural water or effluent of the analyst's choice. Results for the reagent water are given below. Results for other water types and study details are found in "USEPA Method Study 7, Analyses for Trace Methods in Water by Atomic Absorption Spectroscopy (Direct Aspiration) and Colorimetry", National Technical Information Service, 5285 Port Royal Road, Springfield, VA 22161, Order No. PB86-208709/AS, Winter, J.A. and Britton, P.W., June, 1986.

For a concentration range of 20-292 µg/L

$X=0.850(C)-0.25$
 $S=0.198(X)+5.93$
 $SR=0.122(X)+3.10$

where:

C=True Value for the Concentration, µg/L
 X=Mean Recovery, µg/L
 S=Multi-laboratory Standard Deviation, µg/L
 SR=Single-analyst Standard Deviation, µg/L

Method 213.1

For Cadmium, Method 213.1 (Atomic Absorption, Direct Aspiration) replace the Precision and Accuracy Section with the following:

Precision and Accuracy

An interlaboratory study on metal analyses by this method was conducted by the Quality Assurance Branch (QAB) of the Environmental Monitoring Systems Laboratory—Cincinnati (EMSL-CI). Synthetic concentrates containing various levels of this element were added to reagent water and a natural water or effluent of the analyst's choice. The digestion procedure was not specified. Results for the reagent water are given below. Results for other water types and study details are found in "USEPA Method Study 7, Analyses for Trace Methods in Water by Atomic Absorption Spectroscopy (Direct Aspiration) and Colorimetry", National Technical Information Service, 5285 Port Royal Road, Springfield, VA 22161, Order No. PB86-208709/AS, Winter, J.A. and Britton, P.W., June, 1986.

For a concentration range of 14-78 µg/L

$X=0.919(C)+2.97$
 $S=0.108(X)+5.08$
 $SR=0.120(X)+0.89$

where:

C=True Value for the Concentration, µg/L
 X=Mean Recovery, µg/L
 S=Multi-laboratory Standard Deviation, µg/L
 SR=Single-analyst Standard Deviation, µg/L

Environmental Protection Agency

Pt. 136, App. D

Method 218.1

For Chromium, Method 218.1 (Atomic Absorption, Direct Aspiration) replace the Precision and Accuracy Section with the following:

Precision and Accuracy

An interlaboratory study on metal analyses by this method was conducted by the Quality Assurance Branch (QAB) of the Environmental Monitoring Systems Laboratory—Cincinnati (EMSL-CI). Synthetic concentrates containing various levels of this element were added to reagent water and a natural water or effluent of the analyst's choice. The digestion procedure was not specified. Results for the reagent water are given below. Results for other water types and study details are found in "USEPA Method Study 7, Analyses for Trace Methods in Water by Atomic Absorption Spectroscopy (Direct Aspiration) and Colorimetry", National Technical Information Service, 5285 Port Royal Road, Springfield, VA 22161, Order No. PB86-208709/AS, Winter, J.A. and Britton, P.W., June 1986.

For a concentration range of 74–407 µg/L

$$X=0.976(C)+3.94$$

$$S=0.131(X)+4.26$$

$$SR=0.052(X)+3.01$$

where:

C=True Value for the Concentration, µg/L

X=Mean Recovery, µg/L

S=Multi-laboratory Standard Deviation, µg/L

SR=Single-analyst Standard Deviation, µg/L

Method 220.1

For Copper, Method 220.1 (Atomic Absorption, Direct Aspiration) replace the Precision and Accuracy Section with the following:

Precision and Accuracy

An interlaboratory study on metal analyses by this method was conducted by the Quality Assurance Branch (QAB) of the Environmental Monitoring Systems Laboratory—Cincinnati (EMSL-CI). Synthetic concentrates containing various levels of this element were added to reagent water and a natural water or effluent of the analyst's choice. The digestion procedure was not specified. Results for the reagent water are given below. Results for other water types and study details are found in "USEPA Method Study 7, Analyses for Trace Methods in Water by Atomic Absorption Spectroscopy (Direct Aspiration) and Colorimetry", National Technical Information Service, 5285 Port Royal Road, Springfield, VA 22161, Order No. PB86-208709/AS, Winter, J.A. and Britton, P.W., June, 1986.

For concentration range 60–332 µg/L

$$X=0.963(C)+3.49$$

$$S=0.047(X)+12.3$$

$$SR=0.042(X)+4.60$$

where:

C=True Value for the Concentration, µg/L

X=Mean Recovery, µg/L

S=Multi-laboratory Standard Deviation, µg/L

SR=Single-analyst Standard Deviation, µg/L

Method 236.1

For Iron, Method 236.1 (Atomic Absorption, Direct Aspiration) replace the Precision and Accuracy Section with the following:

Precision and Accuracy

An interlaboratory study on metal analyses by this method was conducted by the Quality Assurance Branch (QAB) of the Environmental Monitoring Systems Laboratory—Cincinnati (EMSL-CI). Synthetic concentrates containing various levels of this element were added to reagent water and a natural water or effluent of the analyst's choice. The digestion procedure was not specified. Results for the reagent water are given below. Results for other water types and study details are found in "USEPA Method Study 7, Analyses for Trade Methods in Water by Atomic Absorption Spectroscopy (Direct Aspiration) and Colorimetry", National Technical Information Service, 5285 Port Royal Road, Springfield, VA 22161, Order No. PB86-208709/AS, Winter, J.A. and Britton, P.W., June, 1986.

For concentration range 350–840 µg/L

$$X=0.999(C)-2.21$$

$$S=0.022(X)+41.0$$

$$SR=0.019(X)+21.2$$

where:

C=True Value for the Concentration, µg/L

X=Mean Recovery, µg/L

S=Multi-Laboratory Standard Deviation, µg/L

SR=Single-analyst Standard Deviation, µg/L

Method 239.1

For Lead, Method 239.1 (Atomic Absorption, Direct Aspiration) replace Precision and Accuracy Section with the following:

Precision and Accuracy

An interlaboratory study on metal analyses by this method was conducted by the Quality Assurance Branch (QAB) of the Environmental Monitoring Systems Laboratory—Cincinnati (EMSL-CI). Synthetic concentrates containing various levels of this element were added to reagent water and a natural water or effluent of the analyst's choice. The digestion procedure was not specified. Results for the reagent water are given below. Results for other water types and study details are found in "USEPA Method Study 7 Analyses for Trace Methods in Water by Atomic Absorption Spectroscopy

(Direct Aspiration) and Colorimetry"; National Technical Information Service, 5285 Port Royal Road, Springfield, VA 22161, Order No. PB86-208709/AS, Winter, J.A. and Britton, P.W., June, 1986.

For concentration range of 84-367 µg/L

$$\begin{aligned} X &= 0.961(C) + 13.8 \\ S &= 0.028(C) + 33.9 \\ SR &= 0.011(X) + 16.1 \end{aligned}$$

where:

C=True Value for the Concentration, µg/L
 X=Mean Recovery, µg/L
 S=Multi-laboratory Standard Deviation, µg/L
 SR=Single-analyst Standard Deviation, µg/L

Method 243.1

For Manganese, Method 243.1 (Atomic Absorption, Direct Aspiration) replace Precision and Accuracy Section with the following:

Precision and Accuracy

An interlaboratory study on metal analyses by this method was conducted by the Quality Assurance Branch (QAB) of the Environmental Monitoring Systems Laboratory—Cincinnati (EMSL-CI). Synthetic concentrates containing various levels of this element were added to reagent water and a natural water or effluent of the analyst's choice. The digestion procedure was not specified. Results for the reagent water are given below. Results for other water types and study details are found in "USEPA Method Study 7, Analyses for Trace Methods in Water by Atomic Absorption Spectroscopy (Direct Aspiration) and Colorimetry", National Technical Information Service, 5285 Port Royal Road, Springfield, VA 22161, Order No. PB86-208709/AS, Winter, J.A. and Britton, P.W., June, 1986.

For concentration range 84-469 µg/L

$$\begin{aligned} X &= 0.987(C) - 1.27 \\ S &= 0.042(X) + 8.95 \\ SR &= 0.023(X) + 4.90 \end{aligned}$$

where:

C=True Value for the Concentration, µg/L
 X=Mean Recovery, µg/L
 S=Multi-laboratory Standard Deviation, µg/L
 SR=Single-analyst Standard Deviation, µg/L

Method 289.1

For Zinc, Method 289.1 (Atomic Absorption, Direct Aspiration) replace the Precision and Accuracy Section with the following:

Precision and Accuracy

An interlaboratory study on metal analyses by this method was conducted by the Quality Assurance Branch (QAB) of the Environmental Monitoring Systems Laboratory-

Cincinnati (EMSL-CI). Synthetic concentrates containing various levels of this element were added to reagent water and a natural water or effluent of the analyst's choice. The digestion procedure was not specified. Results for the reagent water are given below. Results for other water types and study details are found in "USEPA Method Study 7, Analyses for Trace Methods in Water by Atomic Absorption Spectroscopy (Direct Aspiration) and Colorimetry", National Technical Information Service, 5285 Port Royal Road, Springfield, VA 22161, Order No. PB86-208709/AS, Winter, J. A. and Britton, P. W., June, 1986.

For concentration range 56-310 µg/L

$$\begin{aligned} X &= 0.999(C) + 0.033 \\ S &= 0.078(X) + 10.8 \\ SR &= 0.049(X) + 1.10 \end{aligned}$$

where:

C=True Value for the Concentration, µg/L
 X=Mean Recovery, µg/L
 S=Multi-laboratory Standard Deviation, µg/L
 SR=Single-analyst Standard Deviation, µg/L

Method 202.2

For Aluminum, Method 202.2 (Atomic Absorption, Furnace Technique) replace the Precision and Accuracy Section statement with the following:

Precision and Accuracy

An interlaboratory study on metal analyses by this method was conducted by the Quality Assurance Branch (QAB) of the Environmental Monitoring Systems Laboratory—Cincinnati (EMSL-CI). Synthetic concentrates containing various levels of this element were added to reagent water, surface water, drinking water and three effluents. These samples were digested by the total digestion procedure, 4.1.3 in this manual. Results for the reagent water are given below. Results for other water types and study details are found in "EPA Method Study 31, Trace Metals by Atomic Absorption (Furnace Techniques)", National Technical Information Service, 5285 Port Royal Road, Springfield, VA 22161, Order No. PB 86-121 704/AS, by Copeland, F.R. and Maney, J.P., January 1986.

For a concentration range of 0.46-125 µg/L

$$\begin{aligned} X &= 1.1579(C) - 0.121 \\ S &= 0.4286(X) - 0.124 \\ SR &= 0.2908(X) - 0.082 \end{aligned}$$

where:

C=True Value for the Concentration, µg/L
 X=Mean Recovery, µg/L
 S=Multi-laboratory Standard Deviation, µg/L
 SR=Single-analyst Standard Deviation, µg/L

Environmental Protection Agency

Pt. 136, App. D

Method 204.2

For Antimony, Method 204.2 (Atomic Absorption, Furnace Technique) replace the Precision and Accuracy Section statement with the following:

Precision and Accuracy

An interlaboratory study on metal analyses by this method was conducted by the Quality Assurance Branch (QAB) of the Environmental Monitoring Systems Laboratory—Cincinnati (EMSL-CI). Synthetic concentrates containing various levels of this element were added to reagent water, surface water, drinking water and three effluents. These samples were digested by the total digestion procedure, 4.1.3 in this manual as modified by this method. Results for the reagent water are given below. Results for other water types and study details are found in "EPA Method Study 31, Trace Metals by Atomic Absorption (Furnace Techniques)," National Technical Information Service, 5285 Port Royal Road, Springfield, VA 22161, Order No. PB 86-121 704/AS, by Copeland, F.R. and Maney, J.P., January 1986.

For a concentration range of 10.50–240 µg/L

$$X=0.7219(C)-0.986$$

$$S=0.3732(X)+0.854$$

$$SR=0.1874(X)-0.461$$

where:

C=True Value for the Concentration, µg/L

X=Mean Recovery, µg/L

S=Multi-laboratory Standard Deviation, µg/L

SR=Single-analyst Standard Deviation, µg/L

Method 206.2

For Arsenic, Method 206.2 (Atomic Absorption, Furnace Technique) add the following to the existing Precision and Accuracy statement:

Precision and Accuracy

An interlaboratory study on metal analyses by this method was conducted by the Quality Assurance Branch (QAB) of the Environmental Monitoring Systems Laboratory—Cincinnati (EMSL-CI). Synthetic concentrates containing various levels of this element were added to reagent water, surface water, drinking water and three effluents. Results for the reagent water are given below. Results for other water types and study details are found in "EPA Method Study 31, Trace Metals by Atomic Absorption (Furnace Techniques)," National Technical Information Service, 5285 Port Royal Road, Springfield, VA 22161, Order No. PB 86-121 704/AS, by Copeland, F.R. and Maney, J.P., January 1986.

For a concentration range of 9.78–237 µg/L

$$X=0.9652(C)+2.112$$

$$S=0.1411(X)+1.873$$

$$SR=0.0464(X)+2.109$$

where:

C=True Value for the Concentration, µg/L

X=Mean Recovery, µg/L

S=Multi-laboratory Standard Deviation, µg/L

SR=Single-analyst Standard Deviation, µg/L

Method 208.2

For Barium, Method 208.2 (Atomic Absorption, Furnace Technique) add the following to the existing Precision and Accuracy information:

Precision and Accuracy

An interlaboratory study on metal analyses by this method was conducted by the Quality Assurance Branch (QAB) of the Environmental Monitoring Systems Laboratory—Cincinnati (EMSL-CI). Synthetic concentrates containing various levels of this element were added to reagent water, surface water, drinking water and three effluents. These samples were digested by the total digestion procedure, 4.1.3 in this manual. Results for the reagent water are given below. Results for other water types and study details are found in "EPA Method Study 31, Trace Metals by Atomic Absorption (Furnace Techniques)," National Technical Information Service, 5285 Port Royal Road, Springfield, VA 22161, Order No. PB 86-121 704/AS, by Copeland, F.R. and Maney, J.P., January 1986.

For a concentration range of 56.50–437 µg/L

$$X=0.8268(C)+59.459$$

$$S=0.2466(X)+6.436$$

$$SR=0.1393(X)-0.428$$

where:

C=True Value for the Concentration, µg/L

X=Mean Recovery, µg/L

S=Multi-laboratory Standard Deviation, µg/L

SR=Single-analyst Standard Deviation, µg/L

Method 210.2

For Beryllium, Method 210.2 (Atomic Absorption, Furnace Technique) replace the existing Precision and Accuracy statement with the following:

Precision and Accuracy

An interlaboratory study on metal analyses by this method was conducted by the Quality Assurance Branch (QAB) of the Environmental Monitoring Systems Laboratory—Cincinnati (EMSL-CI). Synthetic concentrates containing various levels of this element were added to reagent water, surface water, drinking water and three effluents. These samples were digested by the total digestion procedure, 4.1.3 in this manual. Results for the reagent water are given below. Results for other water types and study details are found in "EPA Method Study 31,

Trace Metals by Atomic Absorption (Furnace Techniques)," National Technical Information Service, 5285 Port Royal Road, Springfield, VA 22161, Order No. PB 86-121 704/AS, by Copeland, F.R. and Maney, J.P., January 1986.

For a concentration range of 0.45-11.4 µg/L

$$X=1.0682(C)-0.158$$

$$S=0.2167(X)+0.090$$

$$SR=0.1096(X)+0.061$$

where:

C=True Value for the Concentration, µg/L

X=Mean Recovery, µg/L

S=Multi-laboratory Standard Deviation, µg/L

SR=Single-analyst Standard Deviation, µg/L

Method 213.2

For Cadmium, Method 213.2 (Atomic Absorption, Furnace Technique) add the following to the existing Precision and Accuracy information:

Precision and Accuracy

An interlaboratory study on metal analyses by this method was conducted by the Quality Assurance Branch (QAB) of the Environmental Monitoring System Laboratory—Cincinnati (EMSL-CI). Synthetic concentrates containing various levels of this element were added to reagent water, surface water, drinking water and three effluents. These samples were digested by the total digestion procedure, 4.1.3 in this manual. Results for the reagent water are given below. Results for other water types and study details are found in "EPA Method Study 31, Trace Metals by Atomic Absorption (Furnace Techniques)," National Technical Information Service, 5285 Port Royal Road, Springfield, VA 22161, Order No. PB 86-121 704/AS, by Copeland, F.R. and Maney, J.P., January 1986.

For a concentration range of 0.43-12.5 µg/L

$$X=0.9826(C)+0.171$$

$$S=0.2300(X)+0.045$$

$$SR=0.1031(X)+0.116$$

where:

C=True Value for the Concentration, µg/L

X=Mean Recovery, µg/L

S=Multi-laboratory Standard Deviation, µg/L

SR=Single-analyst Standard Deviation, µg/L

Method 218.2

For Chromium, Method 218.2 (Atomic Absorption, Furnace Technique) add the following to the existing Precision and Accuracy Section:

Precision and Accuracy

An interlaboratory study on metal analyses by this method was conducted by the Quality Assurance Branch (QAB) of the Envi-

ronmental Monitoring Systems Laboratory—Cincinnati (EMSL-CI). Synthetic concentrates containing various levels of this element were added to reagent water, surface water, drinking water and three effluents. These samples were digested by the total digestion procedure, 4.1.3 in this manual. Results for the reagent water are given below. Results for other water types and study details are found in "EPA Method Study 31, Trace Metals by Atomic Absorption (Furnace Techniques)," National Technical Information Service, 5285 Port Royal Road, Springfield, VA 22161, Order No. PB 86-121 704/AS, by Copeland, F.R. and Maney, J.P., January 1986.

For a concentration range of 9.87-246 µg/L

$$X=0.9120(C)+0.234$$

$$S=0.1684(X)+0.852$$

$$SR=0.1469(X)+0.315$$

where:

C=True Value for the Concentration, µg/L

X=Mean Recovery, µg/L

S=Multi-laboratory Standard Deviation, µg/L

SR=Single-analyst Standard Deviation, µg/L

Method 219.2

For Cobalt, Method 219.2 (Atomic Absorption, Furnace Technique), replace the Precision and Accuracy Section statement with the following:

Precision and Accuracy

An interlaboratory study on metal analyses by this method was conducted by the Quality Assurance Branch (QAB) of the Environmental Monitoring Systems Laboratory—Cincinnati (EMSL-CI). Synthetic concentrates containing various levels of this element were added to reagent water, surface water, drinking water and three effluents. These samples were digested by the total digestion procedure, 4.1.3 in this manual. Results for the reagent water are given below. Results for other water types and study details are found in "EPA Method Study 31, Trace Metals by Atomic Absorption (Furnace Techniques)," National Technical Information Service, 5285 Port Royal Road, Springfield, VA 22161 Order No. PB 86-121 704/AS, by Copeland, F.R. and Maney, J.P., January 1986.

For a concentration range of 21.10-461 µg/L

$$X=0.8875(C)+0.859$$

$$S=0.2481(X)-2.541$$

$$SR=0.0969(X)+0.134$$

where:

C=True Value for the Concentration, µg/L

X=Mean Recovery, µg/L

S=Multi-laboratory Standard Deviation, µg/L

SR=Single-analyst Standard Deviation, µg/L

Environmental Protection Agency

Pt. 136, App. D

Method 220.2

For Copper, Method 220.2 (Atomic Absorption, Furnace Technique) replace the Precision and Accuracy Section statement with the following:

Precision and Accuracy

An interlaboratory study on metal analyses by this method was conducted by the Quality Assurance Branch (QAB) of the Environmental Monitoring Systems Laboratory—Cincinnati (EMSL-CI). Synthetic concentrates containing various levels of this element were added to reagent water, surface water, drinking water and three effluents. These samples were digested by the total digestion procedure, 4.1.3 in this manual. Results for the reagent water are given below. Results for other water types and study details are found in "EPA Method Study 31, Trace Metals by Atomic Absorption (Furnace Techniques)," National Technical Information Service, 5285 Port Royal Road, Springfield, VA 22161 Order No. PB 86-121 704/AS, by Copeland, F.R. and Maney, J.P., January 1986.

For a concentration range of 0.30–245 µg/L

$$X=0.9253(C)+0.010$$

$$S=0.2735(X)-0.058$$

$$SR=0.2197(X)-0.050$$

where:

C=True Value for the Concentration, µg/L

X=Mean Recovery, µg/L

S=Multi-laboratory Standard Deviation, µg/L

SR=Single-analyst Standard Deviation, µg/L

Method 236.2

For Iron, Method 236.2 (Atomic Absorption, Furnace Technique) replace the Precision and Accuracy Section statement with the following:

Precision and Accuracy

An interlaboratory study on metal analyses by this method was conducted by the Quality Assurance Branch (QAB) of the Environmental Monitoring Systems Laboratory—Cincinnati (EMSL-CI). Synthetic concentrates containing various levels of this element were added to reagent water, surface water, drinking water and three effluents. These samples were digested by the total digestion procedure, 4.1.3 in this manual. Results for the reagent water are given below. Results for other water types and study details are found in "EPA Method Study 31, Trace Metals by Atomic Absorption (Furnace Techniques)," National Technical Information Service, 5285 Port Royal Road, Springfield, VA 22161 Order No. PB 86-121 704/AS, by Copeland, F.R. and Maney, J.P., January 1986.

For a concentration range of 0.37–455 µg/L

$$X=1.4494(C)-0.229$$

$$S=0.3611(X)-0.079$$

$$SR=0.3715(X)-0.161$$

where:

C=True Value for the Concentration, µg/L

X=Mean Recovery, µg/L

S=Multi-laboratory Standard Deviation, µg/L

SR=Single-analyst Standard Deviation, µg/L

Method 239.2

For Lead, Method 239.2 (Atomic Absorption, Furnace Technique) add the following to the existing Precisions and Accuracy Section:

Precision and Accuracy

An interlaboratory study on metal analyses by this method was conducted by the Quality Assurance Branch (QAB) of the Environmental Monitoring Systems Laboratory—Cincinnati (EMSL-CI). Synthetic concentrates containing various levels of this element were added to reagent water, surface water, drinking water and three effluents. These samples were digested by the total digestion procedure, 4.1.3 in this manual. Results for the reagent water are given below. Results for other water types and study details are found in "EPA Method Study 31, Trace Metals by Atomic Absorption (Furnace Techniques)," National Technical Information Service, 5285 Port Royal Road, Springfield, VA 22161 Order No. PB 86-121 704/AS, by Copeland, F.R. and Maney, J.P., January 1986.

For a concentration range of 10.40–254 µg/L

$$X=0.9430(C)-0.504$$

$$S=0.2224(X)+0.507$$

$$SR=0.1931(X)-0.378$$

where:

C=True Value for the Concentration, µg/L

X=Mean Recovery, µg/L

S=Multi-laboratory Standard Deviation, µg/L

SR=Single-analyst Standard Deviation, µg/L

Method 243.2

For Manganese, Method 243.2 (Atomic Absorption, Furnace Technique) replace the Precision and Accuracy Section statement with the following:

Precision and Accuracy

An interlaboratory study on metal analyses by this method was conducted by the Quality Assurance Branch (QAB) of the Environmental Monitoring Systems Laboratory—Cincinnati (EMSL-CI). Synthetic concentrates containing various levels of this element were added to reagent water, surface water, drinking water and three effluents. These samples were digested by the total digestion procedure, 4.1.3 in this manual. Results for the reagent water are given below.

Pt. 136, App. D

40 CFR Ch. I (7-1-08 Edition)

Results for other water types and study details are found in "EPA Method Study 31, Trace Metals by Atomic Absorption (Furnace Techniques)," National Technical Information Service, 5285 Port Royal Road, Springfield, VA 22161. Order No. PB 86-121 704/AS, by Copeland, F.R. and Maney, J.P., January 1986.

For a concentration range of 0.42-666 µg/L
X=1.0480(C)+1.404
S=0.2001(X)+1.042
SR=0.1333(X)+0.680

where:

C=True Value for the Concentration, µg/L
X=Mean Recovery, µg/L
S=Multi-laboratory Standard Deviation, µg/L
SR=Single-analyst Standard Deviation, µg/L

Method 249.2

For Nickel, Method 249.2 (Atomic Absorption, Furnace Technique) replace the Precision and Accuracy Section statement with the following:

Precision and Accuracy

An interlaboratory study on metal analyses by this method was conducted by the Quality Assurance Branch (QAB) of the Environmental Monitoring Systems Laboratory—Cincinnati (EMSL—CI). Synthetic concentrates containing various levels of this element were added to reagent water, surface water, drinking water and three effluents. These samples were digested by the total digestion procedure, 4.1.3 in this manual. Results for the reagent water are given below. Results for other water types and study details are found in "EPA Method Study 31, Trace Metals by Atomic Absorption (Furnace Techniques)," National Technical Information Service, 5285 Port Royal Road, Springfield, VA 22161. Order No. PB 86-121 704/AS, by Copeland, F.R. and Maney, J.P., January 1986.

For a concentration range of 26.20-482 µg/L
X=0.8812(C)+2.426
S=0.2475(X)+1.896
SR=0.1935(X)+1.315

where:

C=True Value for the Concentration, µg/L
X=Mean Recovery, µg/L
S=Multi-laboratory Standard Deviation, µg/L
SR=Single-analyst Standard Deviation, µg/L

Method 270.2

For Selenium, Method 270.2 (Atomic Absorption, Furnace Technique) add the following to the existing Precision and Accuracy Section:

Precision and Accuracy

An interlaboratory study on metal analyses by this method was conducted by the Quality Assurance Branch (QAB) of the Environmental Monitoring Systems Laboratory—Cincinnati (EMSL—CI). Synthetic concentrates containing various levels of this element were added to reagent water, surface water, drinking water and three effluents. Results for the reagent water are given below. Results for other water types and study details are found in "EPA Method Study 31, Trace Metals by Atomic Absorption (Furnace Techniques)," National Technical Information Service, 5285 Port Royal Road, Springfield, VA 22161. Order No. PB 86-121 704/AS, by Copeland, F.R. and Maney, J.P., January 1986.

For a concentration range of 10.00-246 µg/L
X=0.9564(C)+0.476
S=0.1584(X)+0.878
SR=0.0772(X)+0.547

where:

C=True Value for the Concentration, µg/L
X=Mean Recovery, µg/L
S=Multi-laboratory Standard Deviation, µg/L
SR=Single-analyst Standard Deviation, µg/L

Method 272.2

For Silver, Method 272.2 (Atomic Absorption, Furnace Technique) add the following to the existing Precision and Accuracy Section:

Precision and Accuracy

An interlaboratory study on metal analyses by this method was conducted by the Quality Assurance Branch (QAB) of the Environmental Monitoring Systems Laboratory—Cincinnati (EMSL—CI). Synthetic concentrates containing various levels of this element were added to reagent water, surface water, drinking water and three effluents. These samples were digested by the total digestion procedure, 4.1.3 in this manual. Results for the reagent water are given below. Results for other water types and study details are found in "EPA Method Study 31, Trace Metals by Atomic Absorption (Furnace Techniques)," National Technical Information Service, 5285 Port Royal Road, Springfield, VA 22161. Order No. PB 86-121 704/AS, by Copeland, F.R. and Maney, J.P., January 1986.

For a concentration range of 0.45-56.5 µg/L
X=0.9470(C)+0.181
S=0.1805(X)+0.153
SR=0.1417(X)+0.039

where:

C=True Value for the Concentration, µg/L
X=Mean Recovery, µg/L
S=Multi-laboratory Standard Deviation, µg/L

SR=Single-analyst Standard Deviation, $\mu\text{g/L}$

Method 279.2

For Thallium, Method 279.2 (Atomic Absorption, Furnace Technique) replace the Precision and Accuracy Section statement with the following:

Precision and Accuracy

An interlaboratory study on metal analyses by this method was conducted by the Quality Assurance Branch (QAB) of the Environmental Monitoring Systems Laboratory—Cincinnati (EMSL-CI). Synthetic concentrates containing various levels of this element were added to reagent water, surface water, drinking water and three effluents. These samples were digested by the total digestion procedure, 4.1.3 in this manual. Results for the reagent water are given below. Results for other water types and study details are found in "EPA Method Study 31, Trace Metals by Atomic Absorption (Furnace Techniques)," National Technical Information Service, 5285 Port Royal Road, Springfield, VA 22161 Order No. PB 86-121 704/AS, by Copeland, F.R. and Maney, J.P., January 1986.

For a concentration range of 10.00–252 $\mu\text{g/L}$.
 $X=0.8781(C)-0.715$
 $S=0.1112(X)+0.669$
 $SR=0.1005(X)+0.241$

where:

C=True Value for the Concentration, $\mu\text{g/L}$
 X=Mean Recovery, $\mu\text{g/L}$
 S=Multi-laboratory Standard Deviation, $\mu\text{g/L}$
 SR=Single-analyst Standard Deviation, $\mu\text{g/L}$

Method 286.2

For Vanadium, Method 286.2 (Atomic Absorption, Furnace Technique) replace the Precision and Accuracy Section statement with the following:

Precision and Accuracy

An interlaboratory study on metal analyses by this method was conducted by the Quality Assurance Branch (QAB) of the Environmental Monitoring Systems Laboratory—Cincinnati (EMSL-CI). Synthetic concentrates containing various levels of this element were added to reagent water, surface water, drinking water and three effluents. These samples were digested by the total digestion procedure, 4.1.3 in this manual. Results for the reagent water are given below. Results for other water types and study details are found in "EPA Method Study 31, Trace Metals by Atomic Absorption (Furnace Techniques)," National Technical Information Service, 5285 Port Royal Road, Springfield, VA 22161 Order No. PB 86-121 704/AS, by Copeland, F.R. and Maney, J.P., January 1986.

For a concentration range of 1.36–982 $\mu\text{g/L}$.
 $X=0.8486(C)+0.252$
 $S=0.3323(X)-0.428$
 $SR=0.1195(X)-0.121$

where:

C=True Value for the Concentration, $\mu\text{g/L}$
 X=Mean Recovery, $\mu\text{g/L}$
 S=Multi-laboratory Standard Deviation, $\mu\text{g/L}$
 SR=Single-analyst Standard Deviation, $\mu\text{g/L}$

Method 289.2

For Zinc, Method 289.2 (Atomic Absorption, Furnace Technique) replace the Precision and Accuracy Section statement with the following:

Precision and Accuracy

An interlaboratory study on metal analyses by this method was conducted by the Quality Assurance Branch (QAB) of the Environmental Monitoring Systems Laboratory—Cincinnati (EMSL-CI). Synthetic concentrates containing various levels of this element were added to reagent water, surface water, drinking water and three effluents. These samples were digested by the total digestion procedure, 4.1.3 in this manual. Results for the reagent water are given below. Results for other water types and study details are found in "EPA Method Study 31, Trace Metals by Atomic Absorption (Furnace Techniques)," National Technical Information Service, 5285 Port Royal Road, Springfield, VA 22161 Order No. PB 86-121 704/AS, by Copeland, F.R. and Maney, J.P., January 1986.

For a concentration range of 0.51–189 $\mu\text{g/L}$.
 $X=1.6710(C)+1.485$
 $S=0.6740(X)-0.342$
 $SR=0.3895(X)-0.384$

where:

C=True Value for the Concentration, $\mu\text{g/L}$
 X=Mean Recovery, $\mu\text{g/L}$
 S=Multi-laboratory Standard Deviation, $\mu\text{g/L}$
 SR=Single-analyst Standard Deviation, $\mu\text{g/L}$

[55 FR 33442, Aug. 15, 1990]

PART 140—MARINE SANITATION DEVICE STANDARD

Sec.

- 140.1 Definitions.
- 140.2 Scope of standard.
- 140.3 Standard.
- 140.4 Complete prohibition.
- 140.5 Analytical procedures.

AUTHORITY: 33 U.S.C. 1322, as amended.